

TROCAR | BIOPSY NEEDLES

Trokar | Biopsienadeln

Trocart | Aiguilles pour biopsie

Trocar | Aguja para biopsia

Trocar | Aghi da biopsia

ELEVATORS | PERIOSTEAL | BONE FILES | CURETTES

Elevatoren | Raspatorien | Knochenfeilen | Küretten

Élévateurs | Rugines périostique

Elevadores | Periostótomos | Lir

Elevatori | Scollaperiosteo | Lim

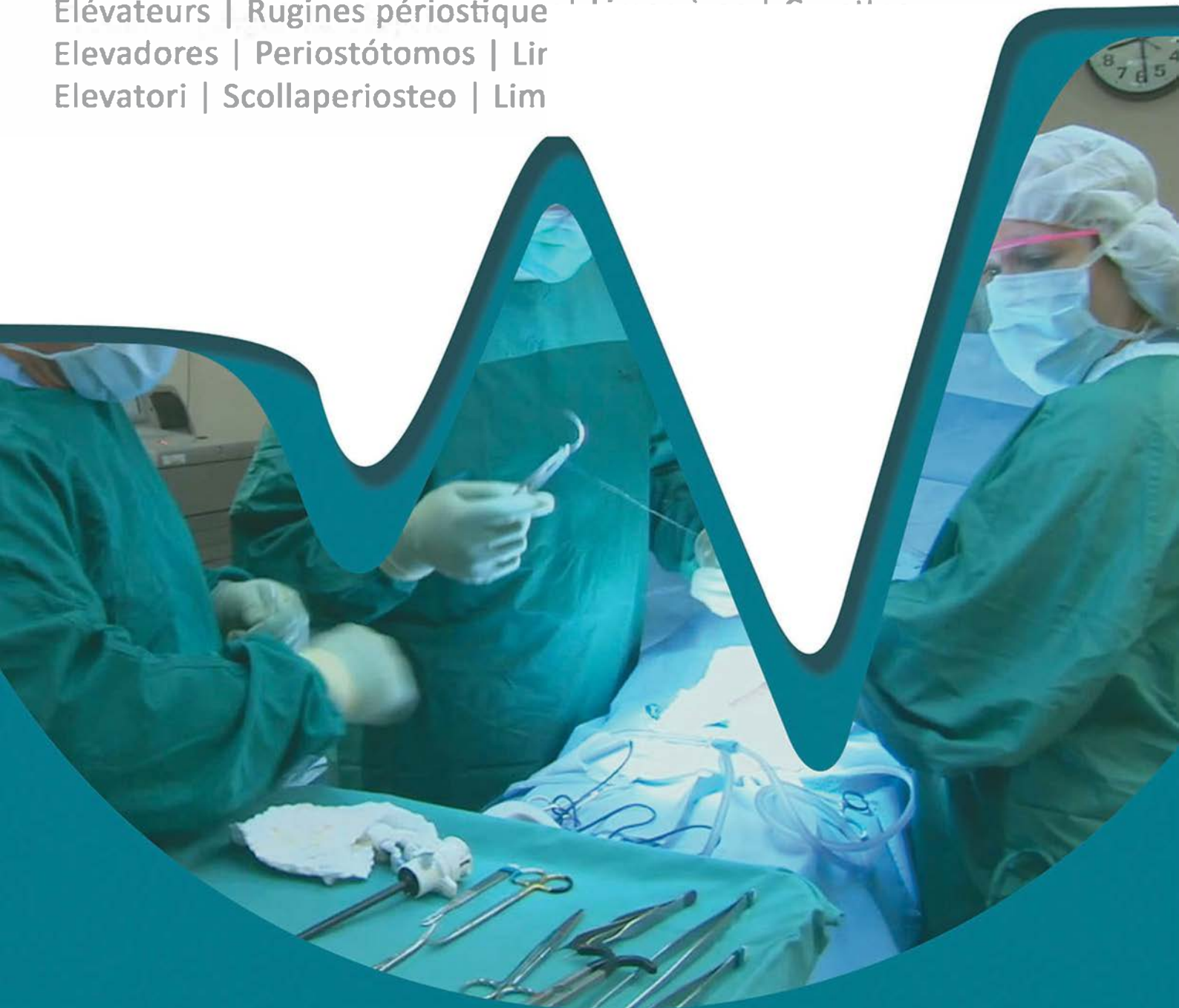

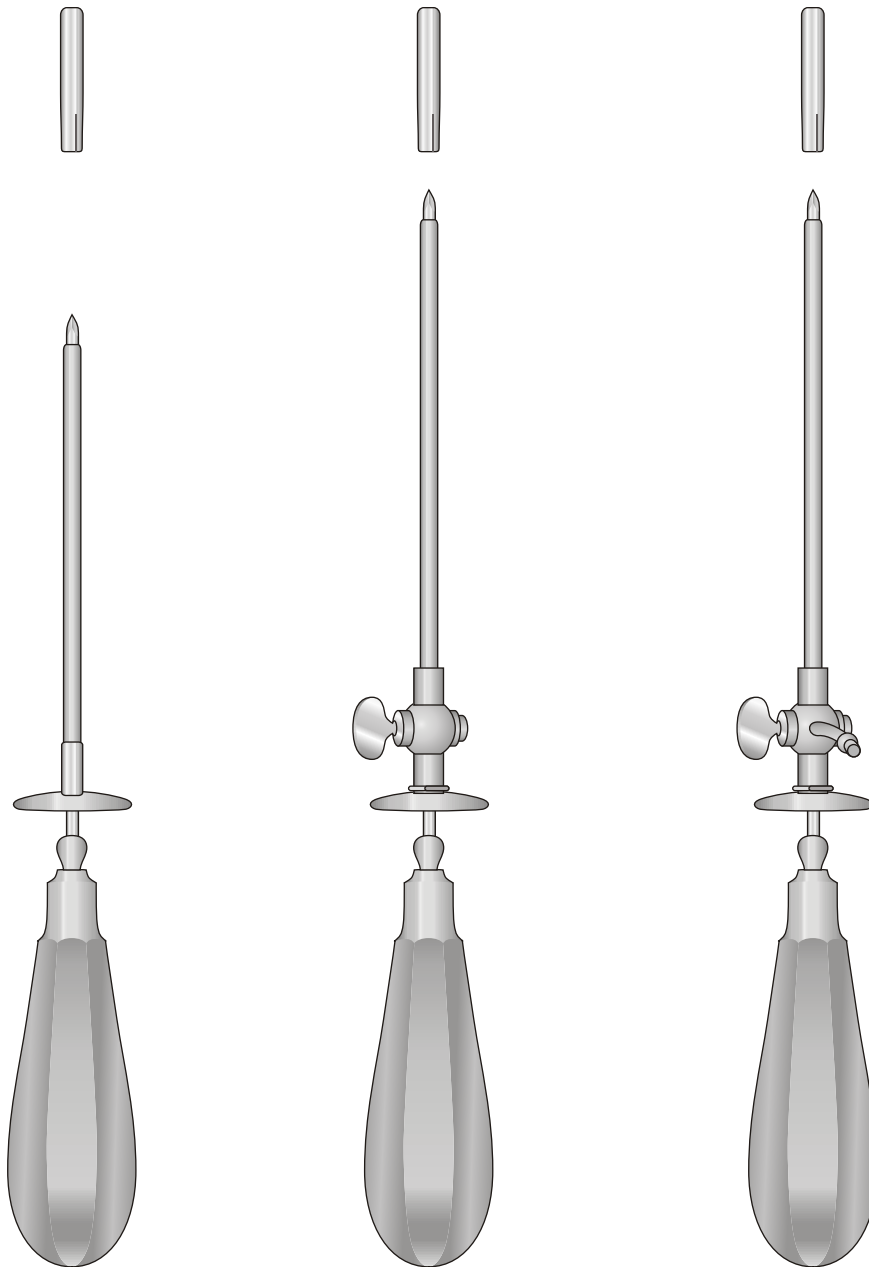

Ø mm Esterno Outside Außen Extérieur Exterior	Ø mm Interno Inside Innen Intérieur Interior	10-100 STANDARD	STANDARD	STANDARD
3,0	2,0	10-100-01	10-110-01	10-120-01
3,5	2,5	10-100-02	10-110-02	10-120-02
4,0	3,0	10-100-03	10-110-03	10-120-03
4,5	3,5	10-100-04	10-110-04	10-120-04
5,0	4,0	10-100-05	10-110-05	10-120-05
5,5	4,5	10-100-06	10-110-06	10-120-06
6,0	5,0	10-100-07	10-110-07	10-120-07
		110 mm	120 mm	120 mm

Per vescica biliare - For gall bladder - Für die gallenblase
Pour la vésicule biliaire - Para vesícula biliar

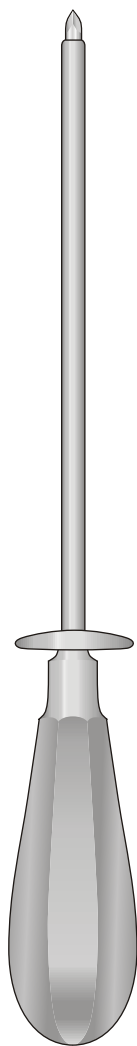
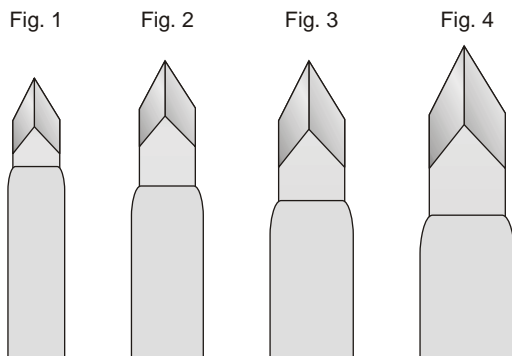

Ø mm Esterno Outside Außen Extérieur Exterior	Ø mm Interno Inside Innen Intérieur Interior		NELSON
7,5	6,0	Fig. 1	10-130-01
9,5	8,0	Fig. 2	10-130-02
11,0	9,5	Fig. 3	10-130-03
12,5	11,0	Fig. 4	10-130-04
210 mm			

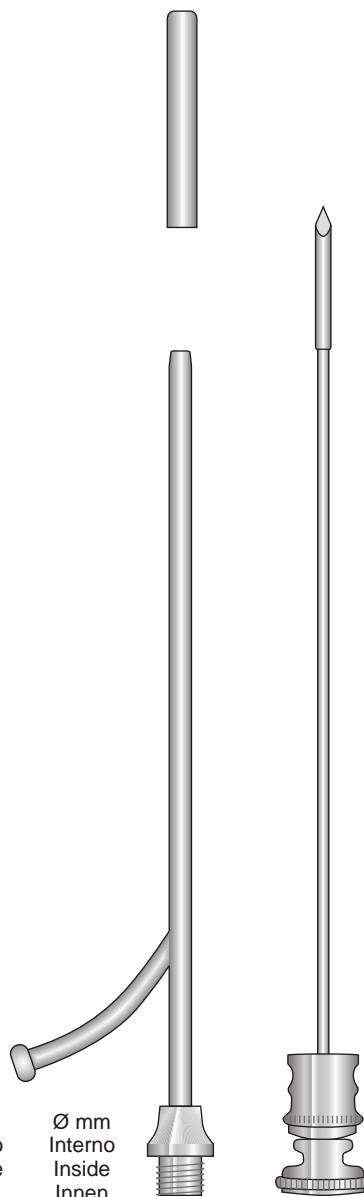

Ø mm Esterno Outside Außen Extérieur Exterior	Ø mm Interno Inside Innen Intérieur Interior	OCHSNER
4,0	3,0	10-140-01
4,6	3,6	10-140-02
5,3	4,3	10-140-03
6,0	5,0	10-140-04
210 mm		

Trequarti per seno mascellare
Antrum puncture trocars
Kieferhöhlentrokare
Trocarts pour sinus maxillaire
Trócares para punción del seno maxilar

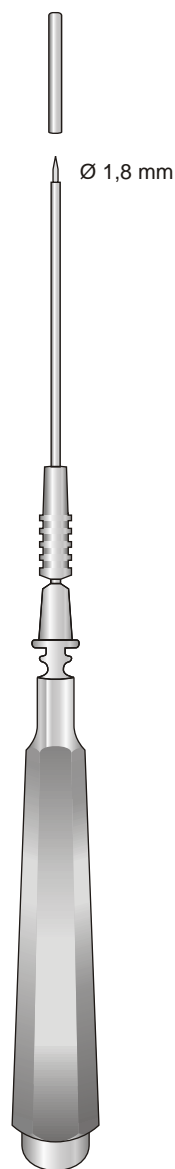

LICHTWITZ
10-150-19
190 mm

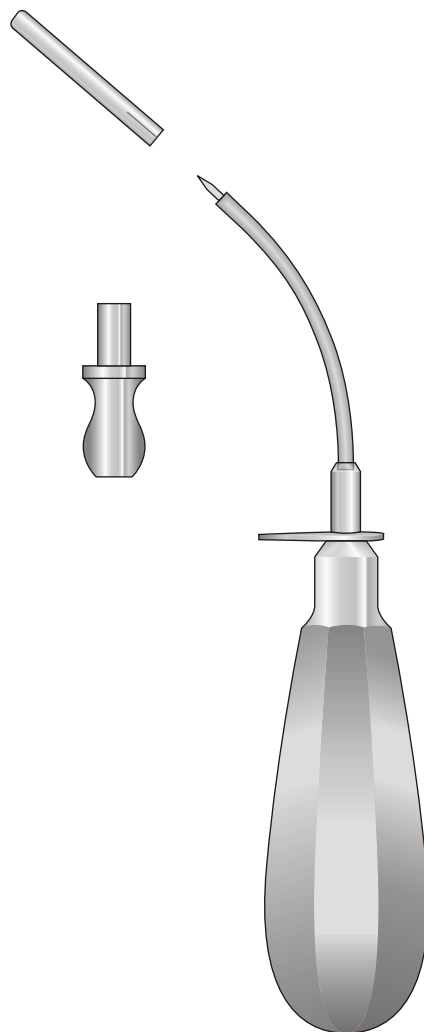

PIERCE
10-160-01 Ø 3 mm
10-160-02 Ø 4 mm
10-160-03 Ø 5 mm
160 mm

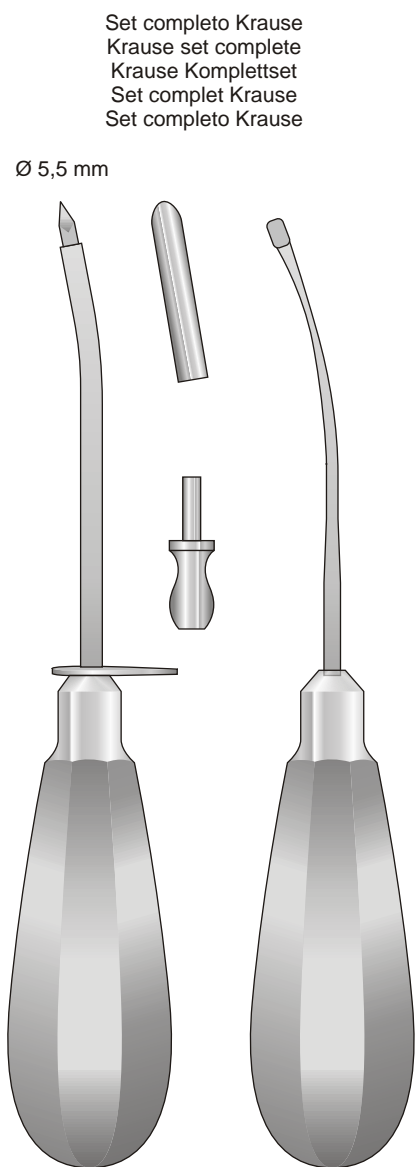

KRAUSE
10-170-16
160 mm

Set completo Krause
Krause set complete
Krause Kompletset
Set complet Krause
Set completo Krause

Universale completo con 3 punte
Set of 3 pieces
Satz zu 3 stück
Jeu de 3 pièces
Juego de 3 piezas

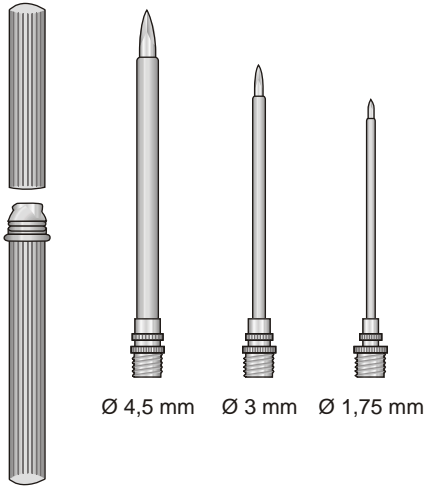

UNIVERSAL
10-180-03

Universale completo con 4 punte
Set of 4 pieces
Satz zu 4 stück
Jeu de 4 pièces
Juego de 4 piezas

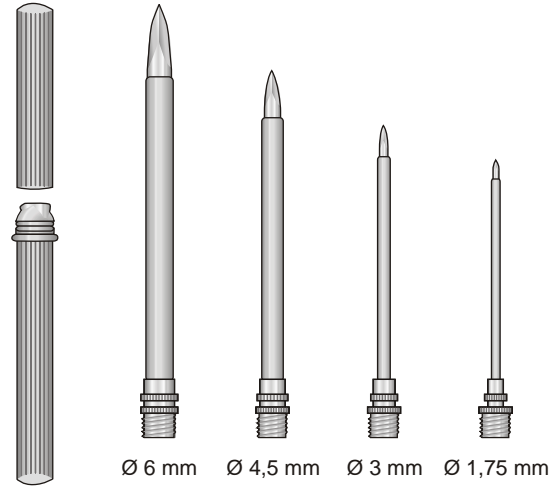

UNIVERSAL
10-180-04

Universale completo con 3 punte
Set of 3 pieces
Satz zu 3 stück
Jeu de 3 pièces
Juego de 3 piezas

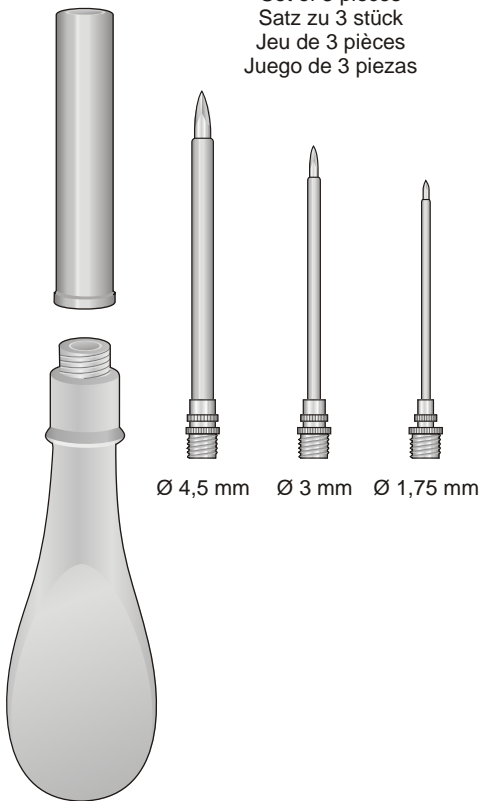

10-190-03
130 mm

Universale completo con 4 punte
Set of 4 pieces
Satz zu 4 stück
Jeu de 4 pièces
Juego de 4 piezas

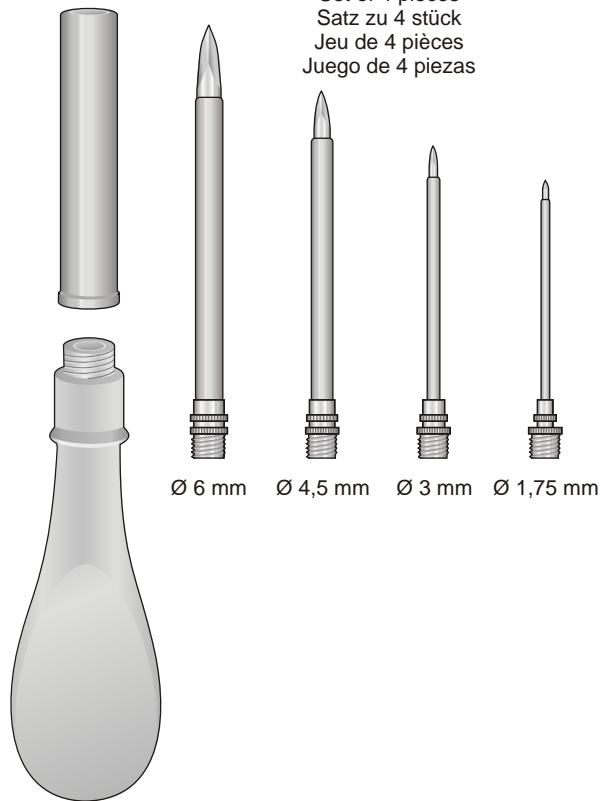

10-190-04
130 mm

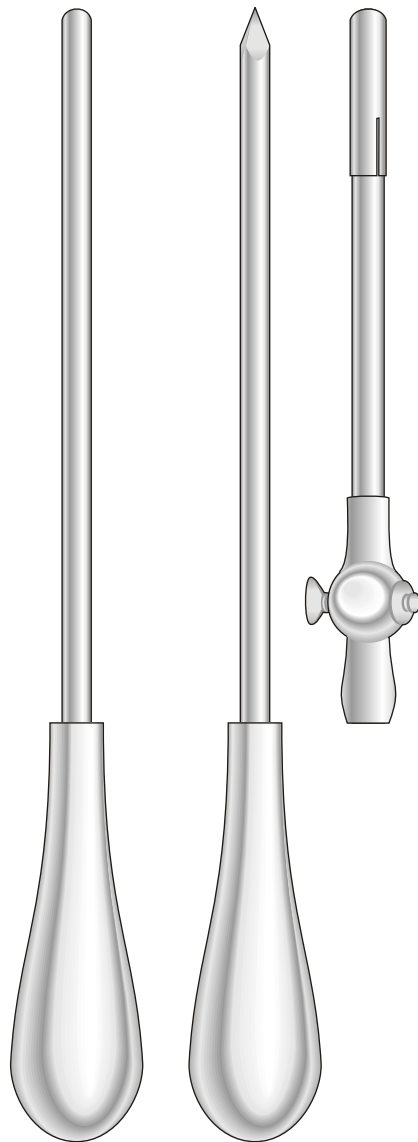

Ø mm	Ø mm
Esterno	Interno
Outside	Inside
Außen	Innen
Extérieur	Intérieur
Exterior	Interior

		BUELAU
8	6,5	10-200-01
10	8,5	10-200-02

240 mm

Ago per la puntura dello sterno
Sternal puncture needle
Sternal-punktionskänülen
Aiguilles pour la ponction sternale
Agujas para punción esternal

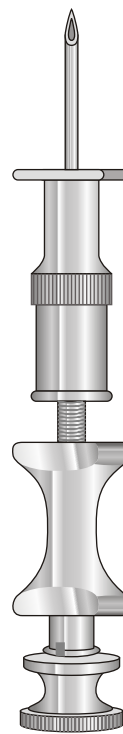

KLIMA-ROSEGGER
10-210-01
1,80 x 35 mm

DUKE

110 mm - 5,5 mm

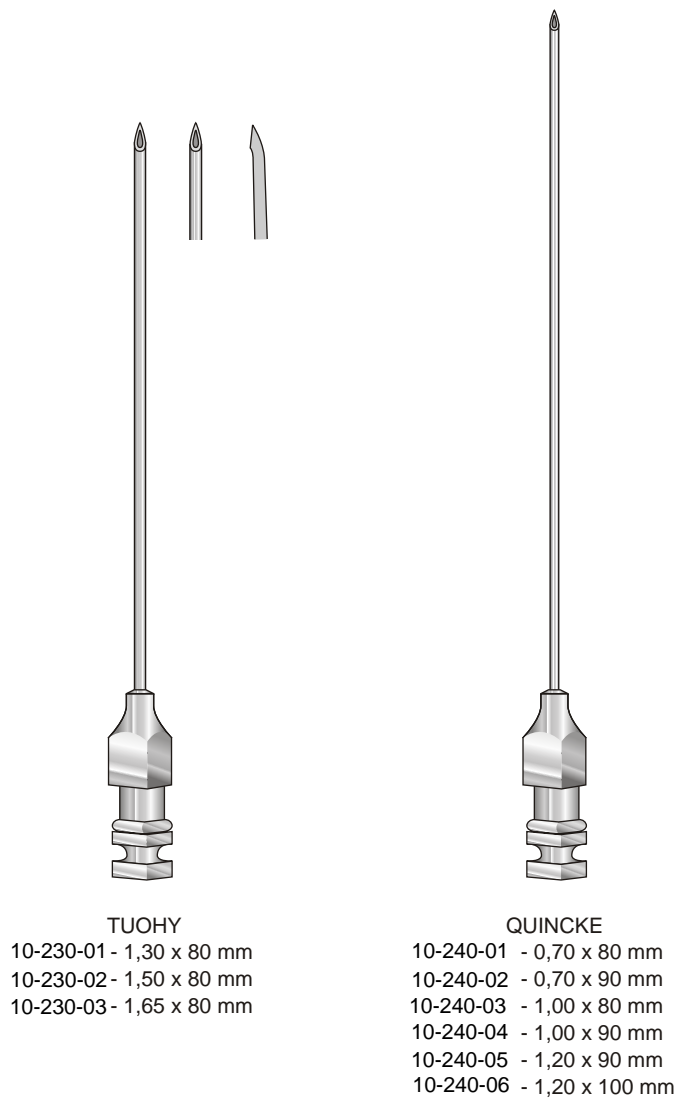
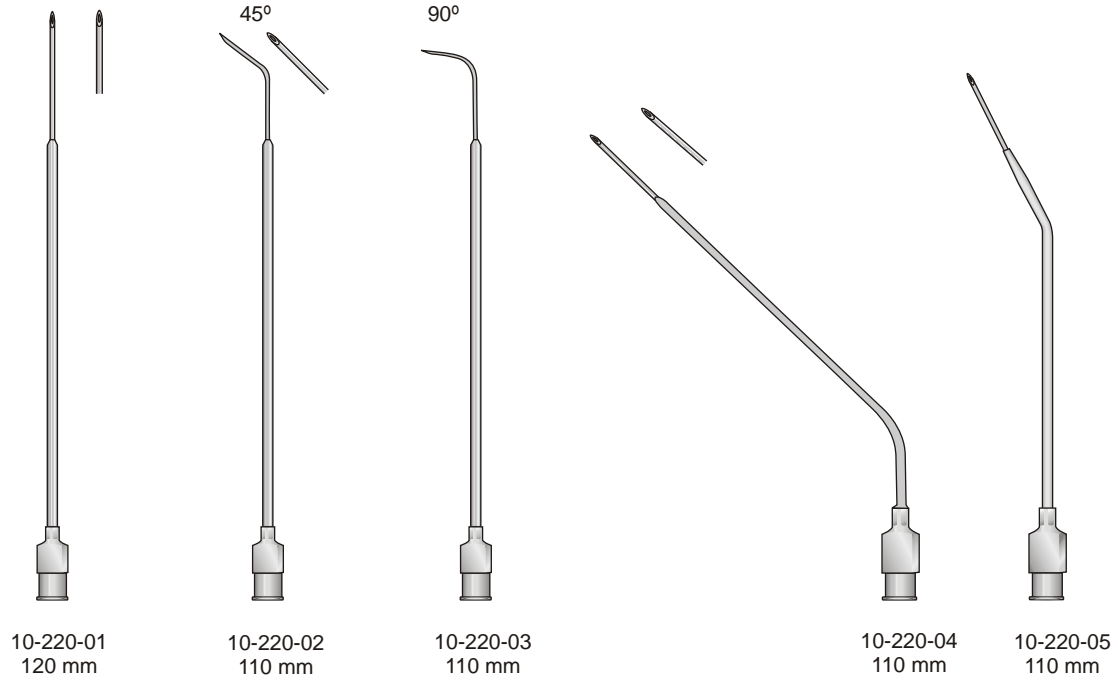

6 mm



8 mm

10-250-01
135 mm

8 mm



10 mm

10-250-02
135 mm

4,5 mm

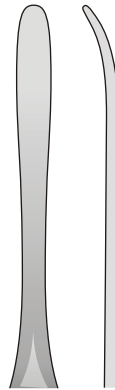

1/1

KÖNIG
10-260-01
155 mm

4,5 mm

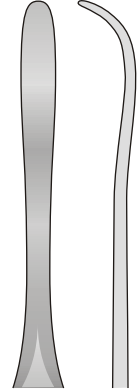

1/1

KÖNIG
10-260-02
155 mm

5 mm

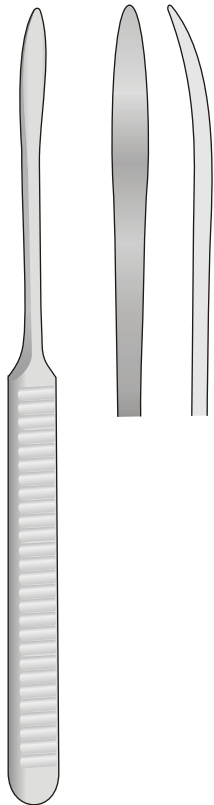

1/1

WILLIGER
10-270-01
165 mm

6 mm

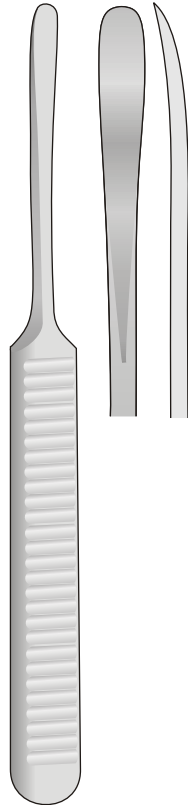

1/1

WILLIGER
10-270-02
160 mm

4 mm

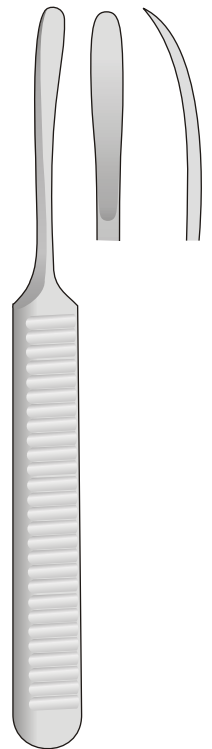

1/1

WILLIGER
10-270-03
140 mm

Periostotomi
Periosteal Raspatories
Raspatorien
Rugines à périostomie
Legras periostotomos

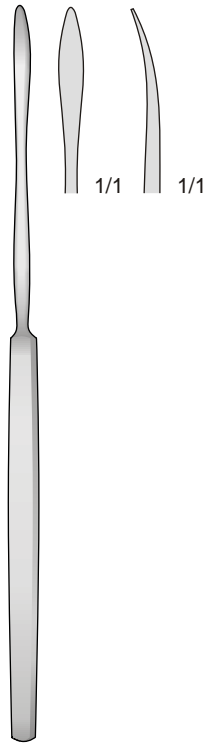

10-280-01
175 mm

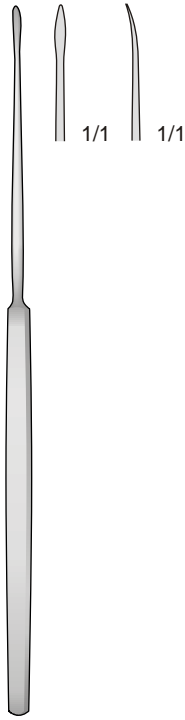

10-280-02
160 mm

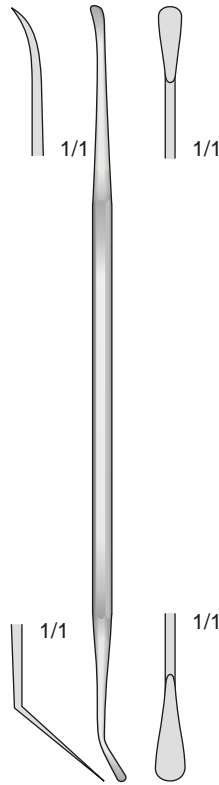

MILLIGAN
10-290-21
210 mm

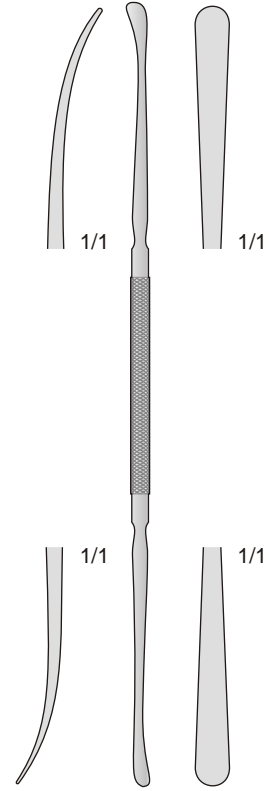

DAVIS
10-300-24
245 mm

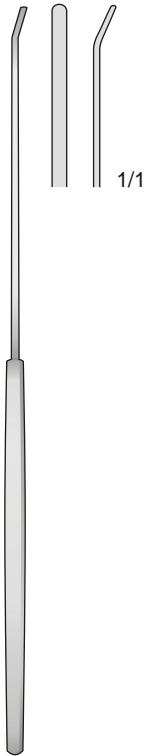

FAGER
10-310-01
200 mm

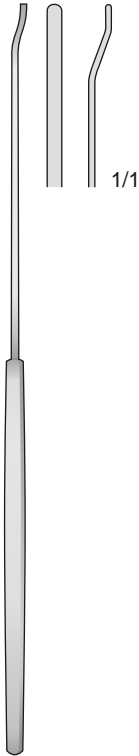

FAGER
10-310-02
200 mm

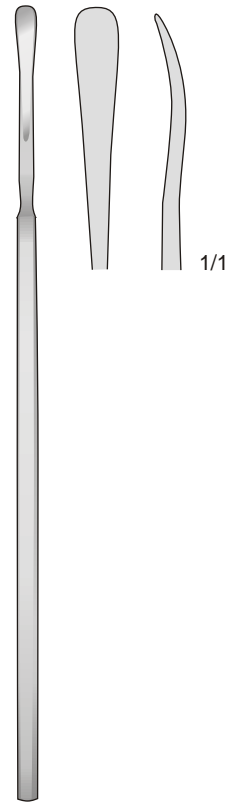

SACHS
10-320-01
210 mm

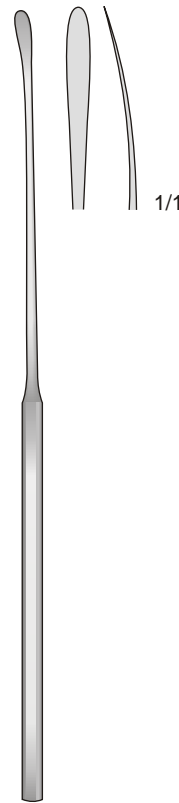

SACHS
10-320-02
210 mm

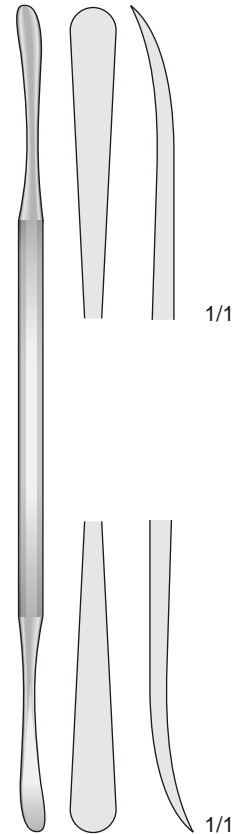

10-330-22
220 mm

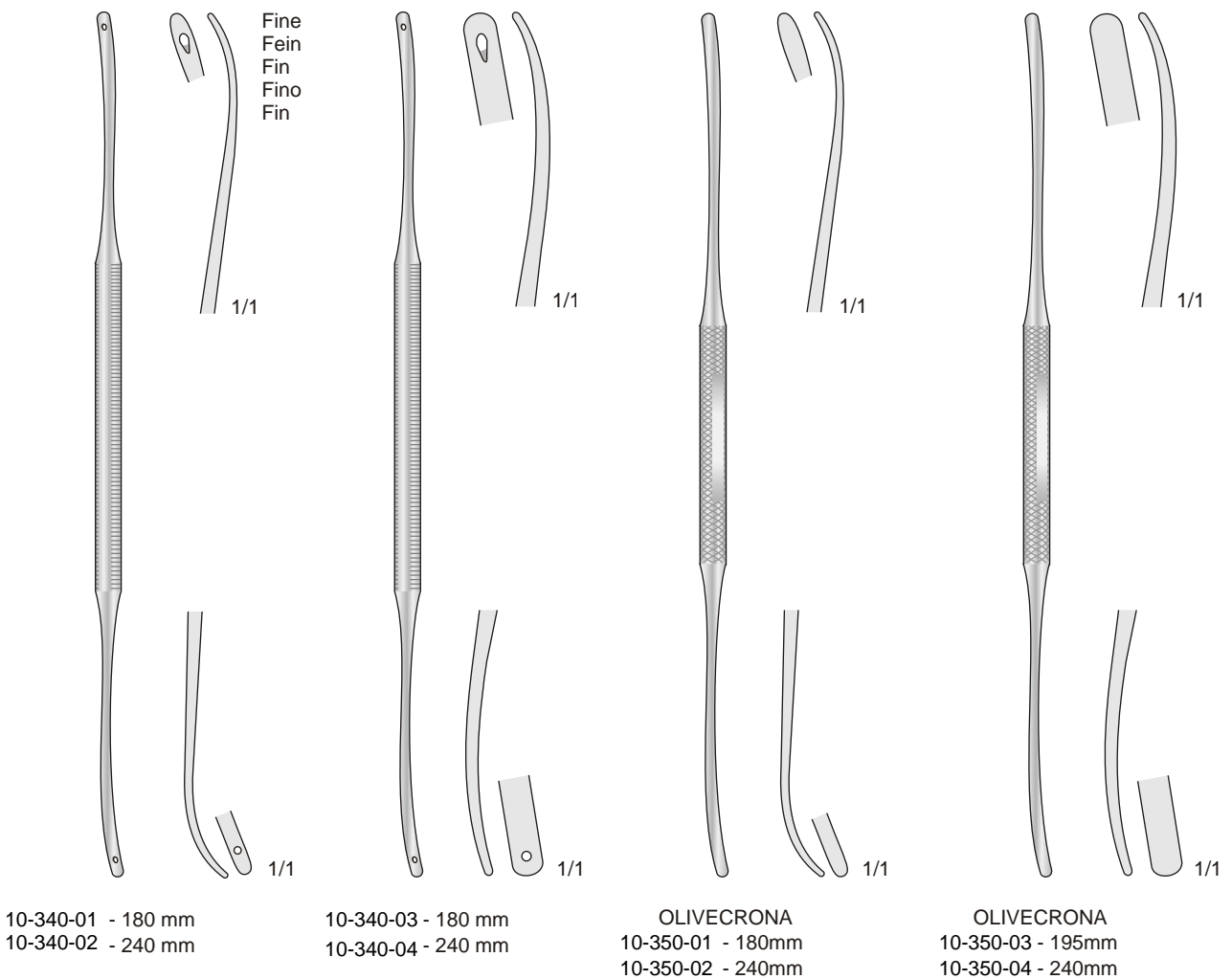

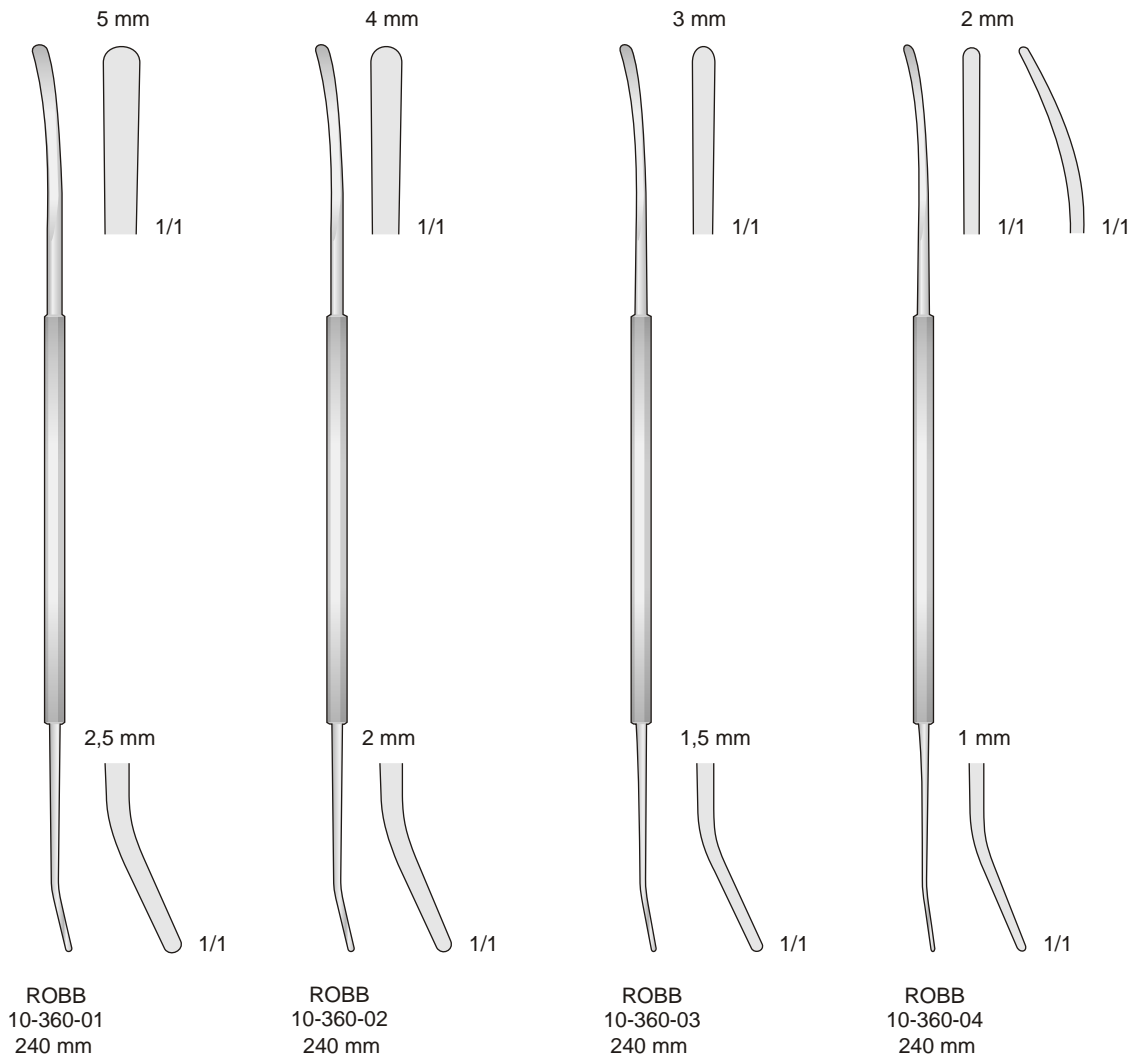

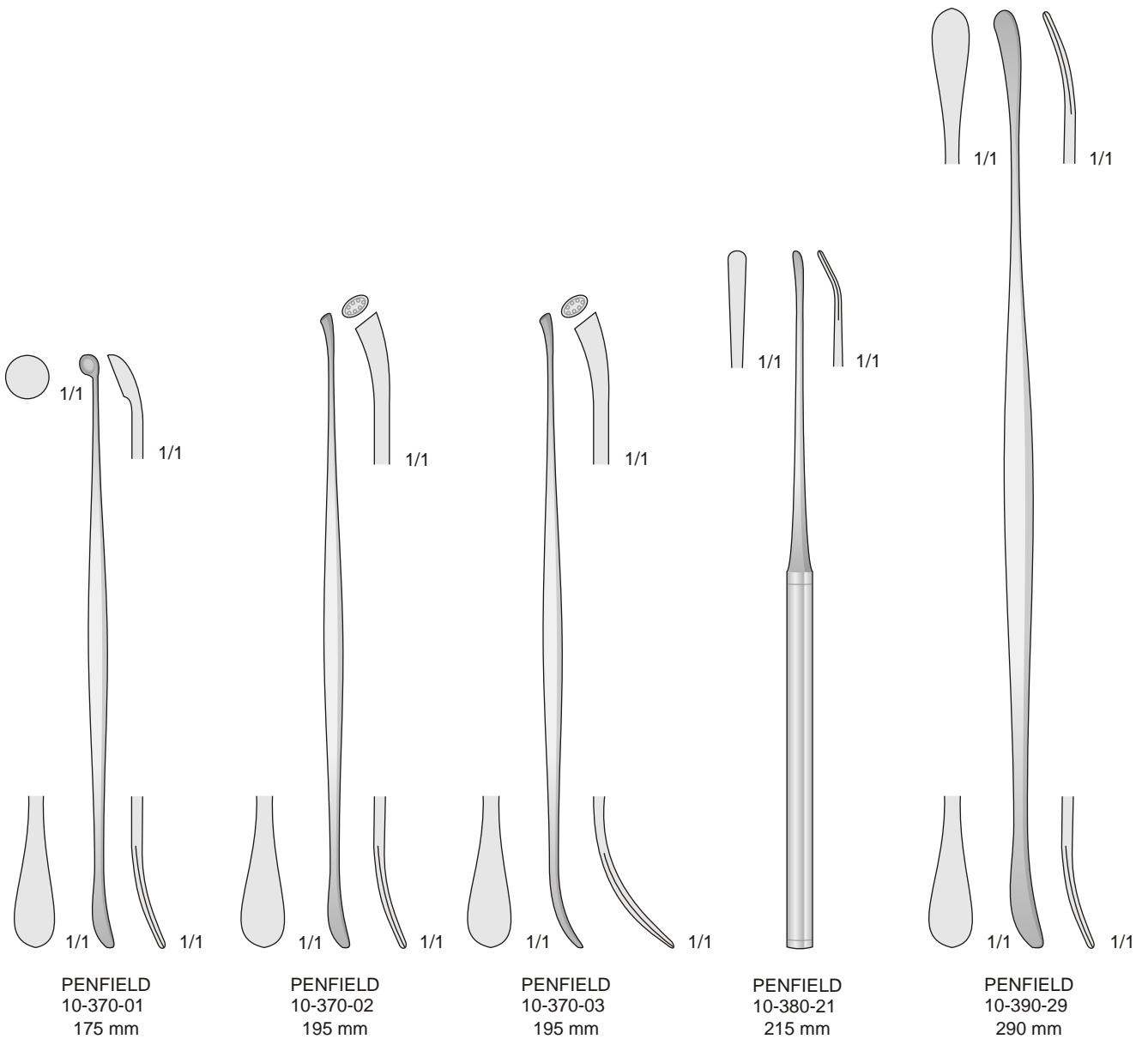

Nerve protectors

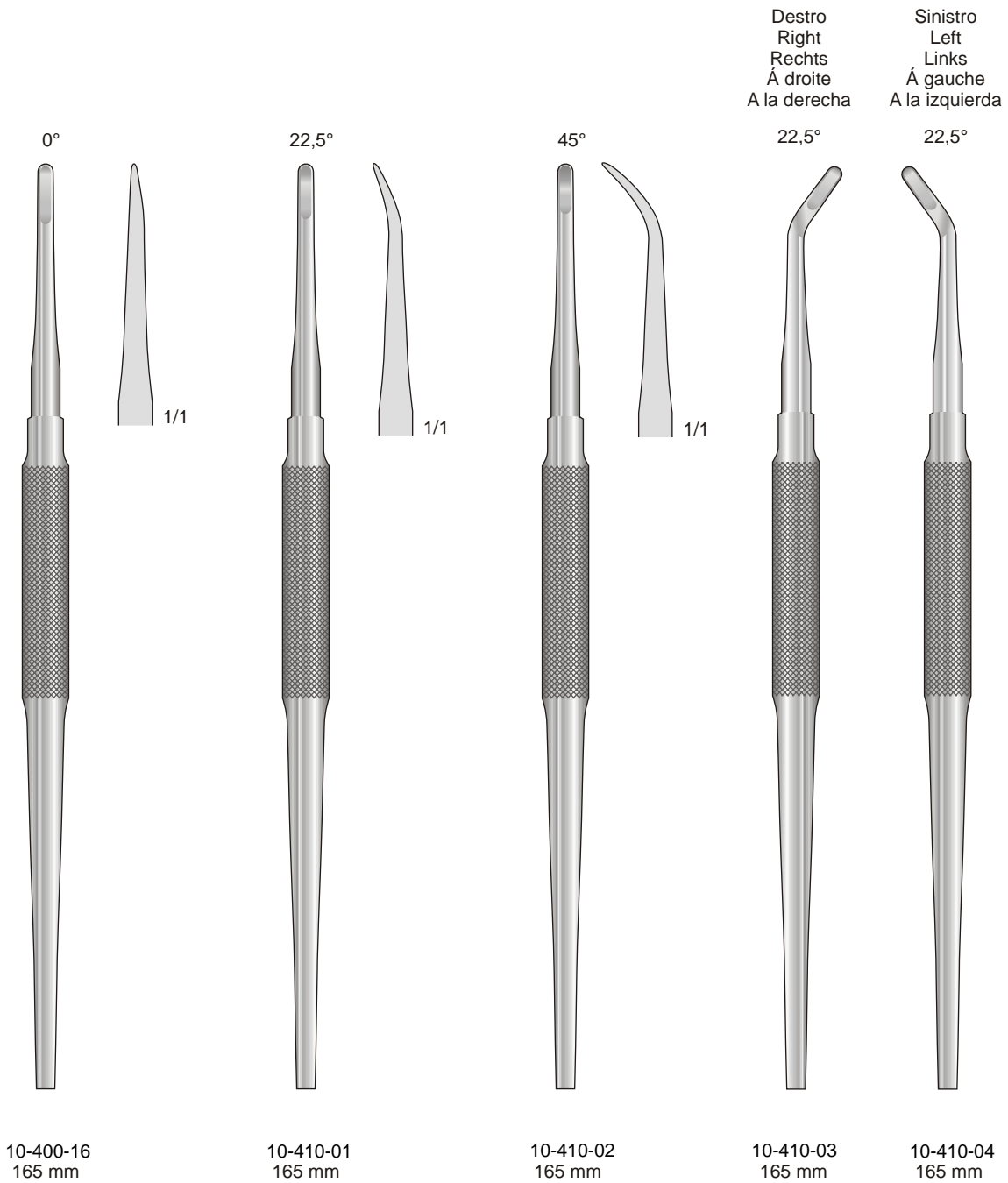

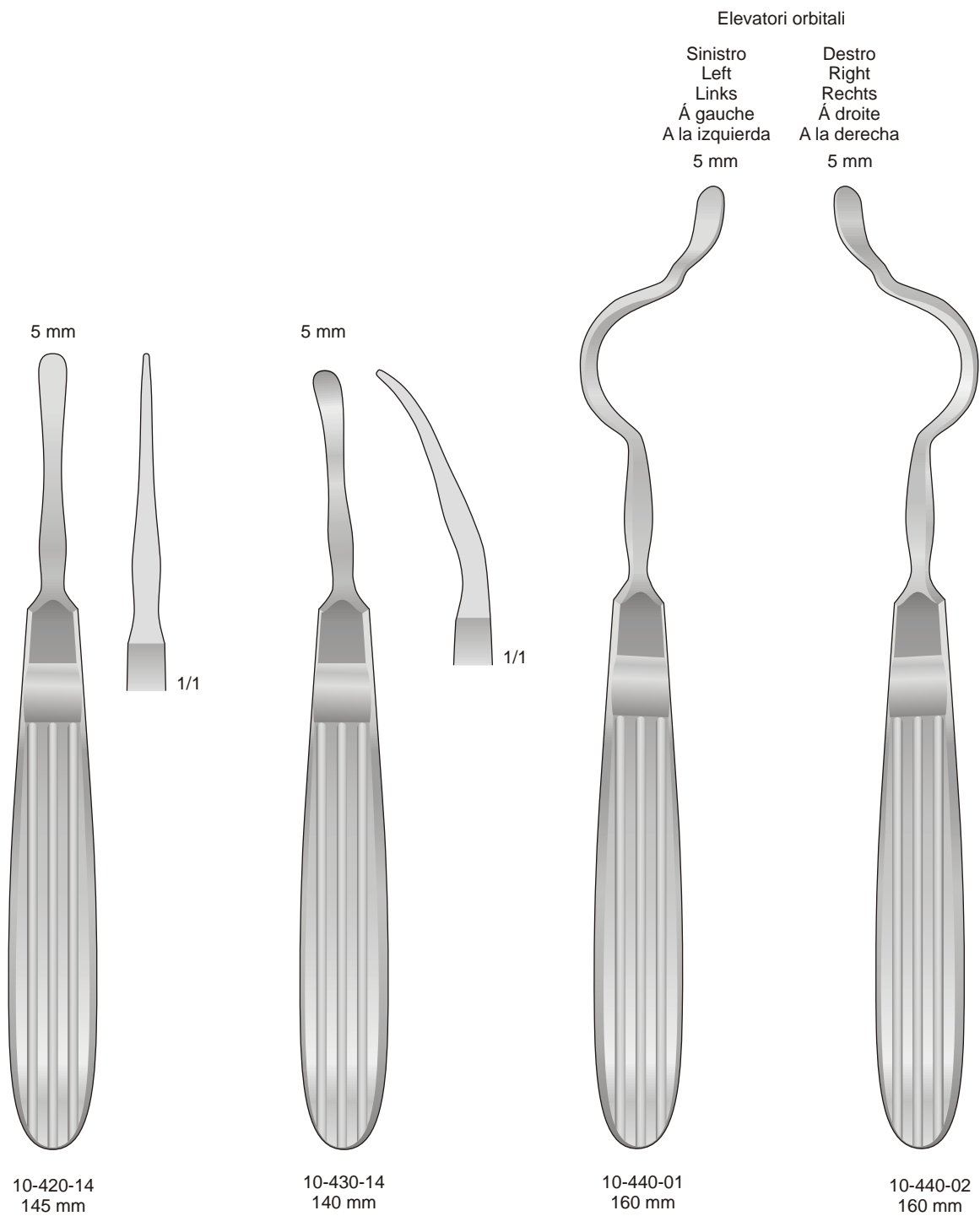

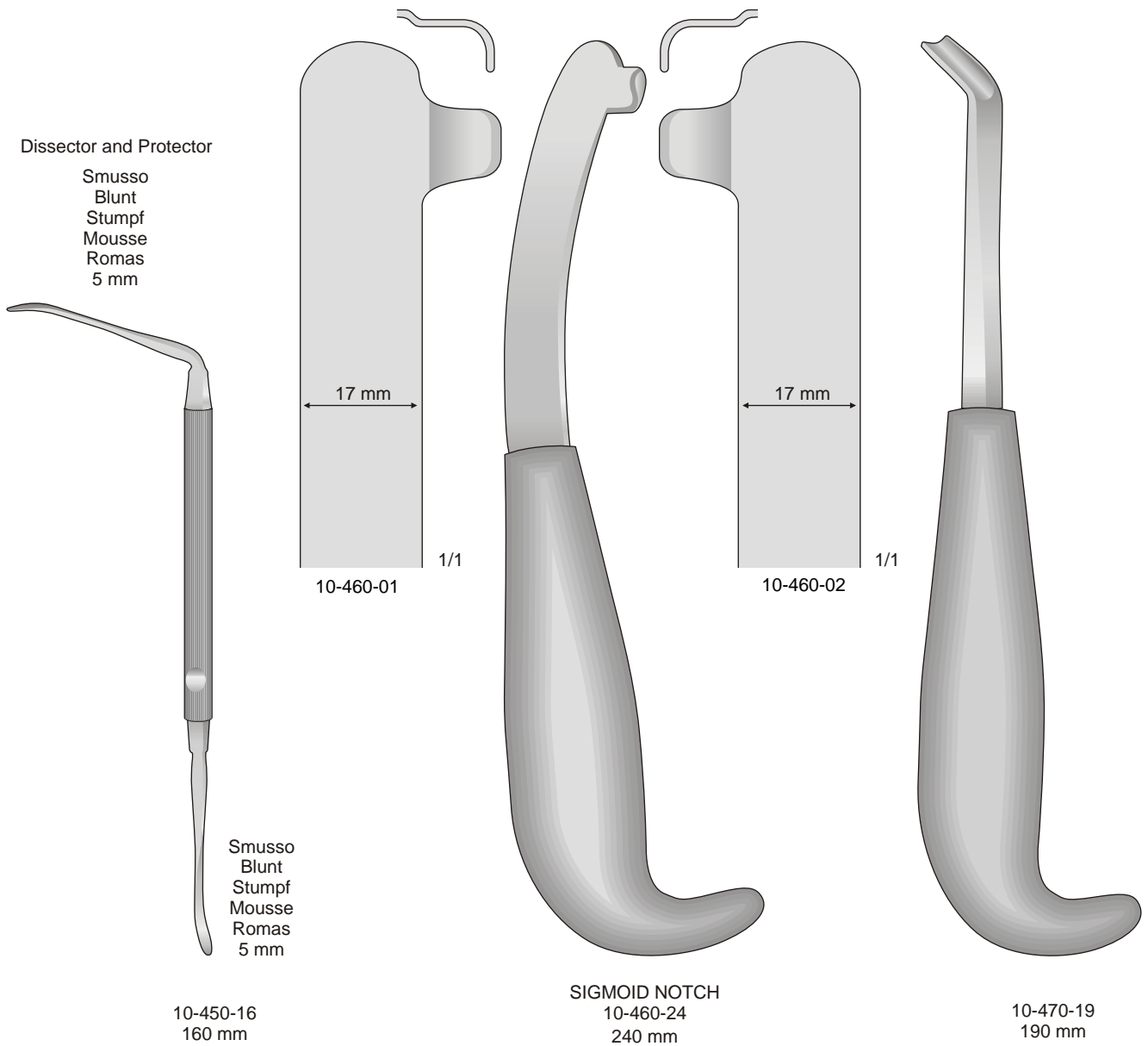

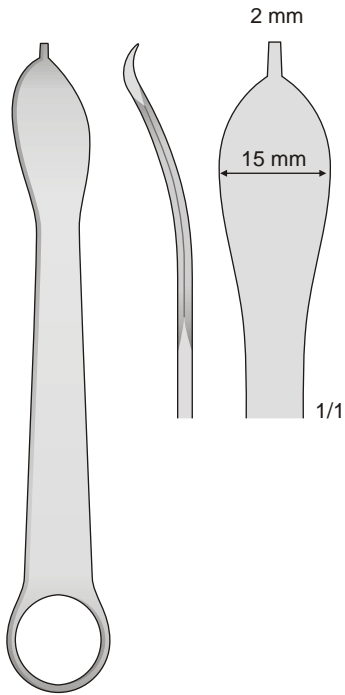

10-480-12
120 mm

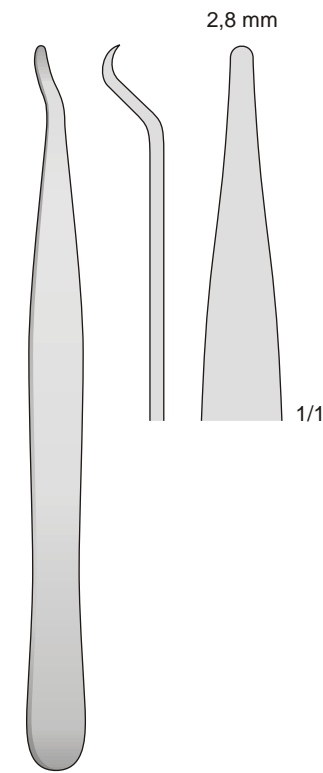

10-490-14
140 mm

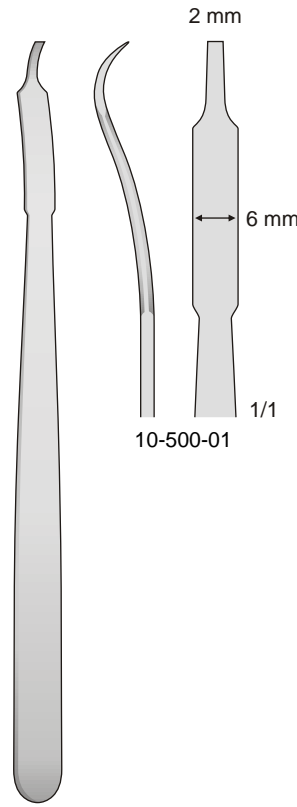

MINI-HOHMANN
10-500-01
160 mm

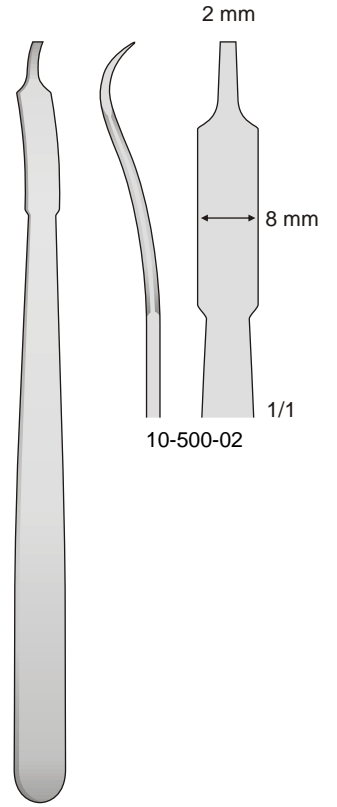

MINI-HOHMANN
10-500-02
160 mm

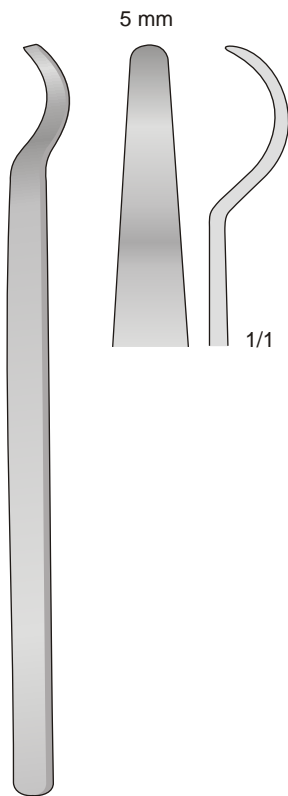

10-510-05
150 mm

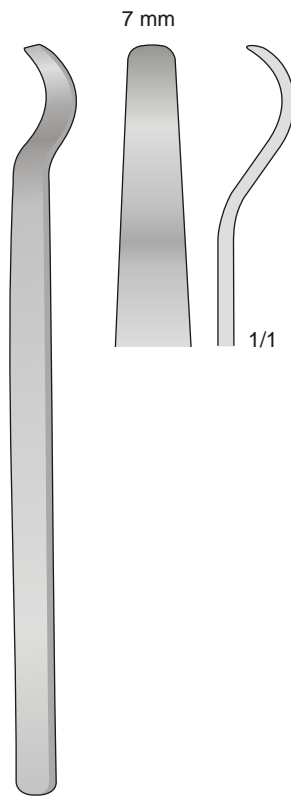

10-510-07
150 mm

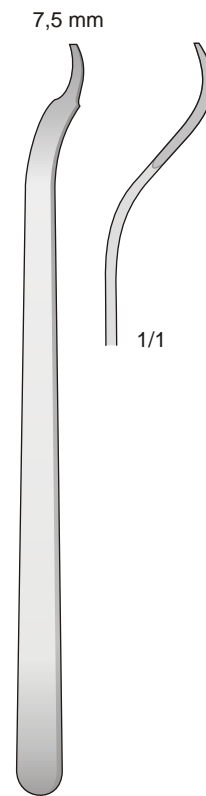

BUCK-GRAMCKO
10-520-15
150 mm

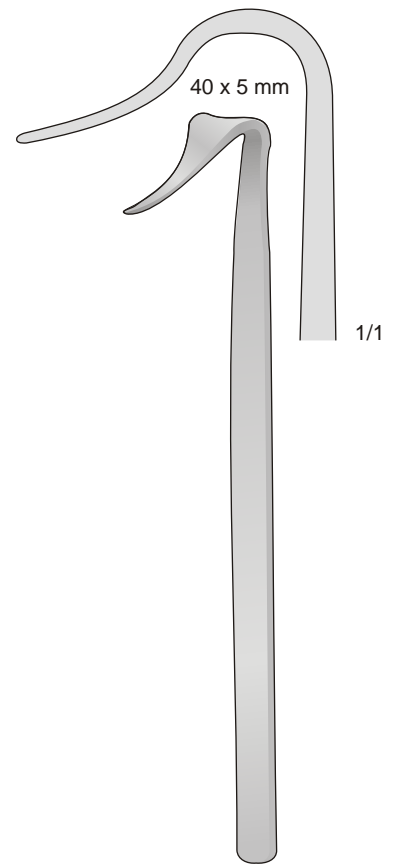

BLOUNT
10-530-17
175 mm

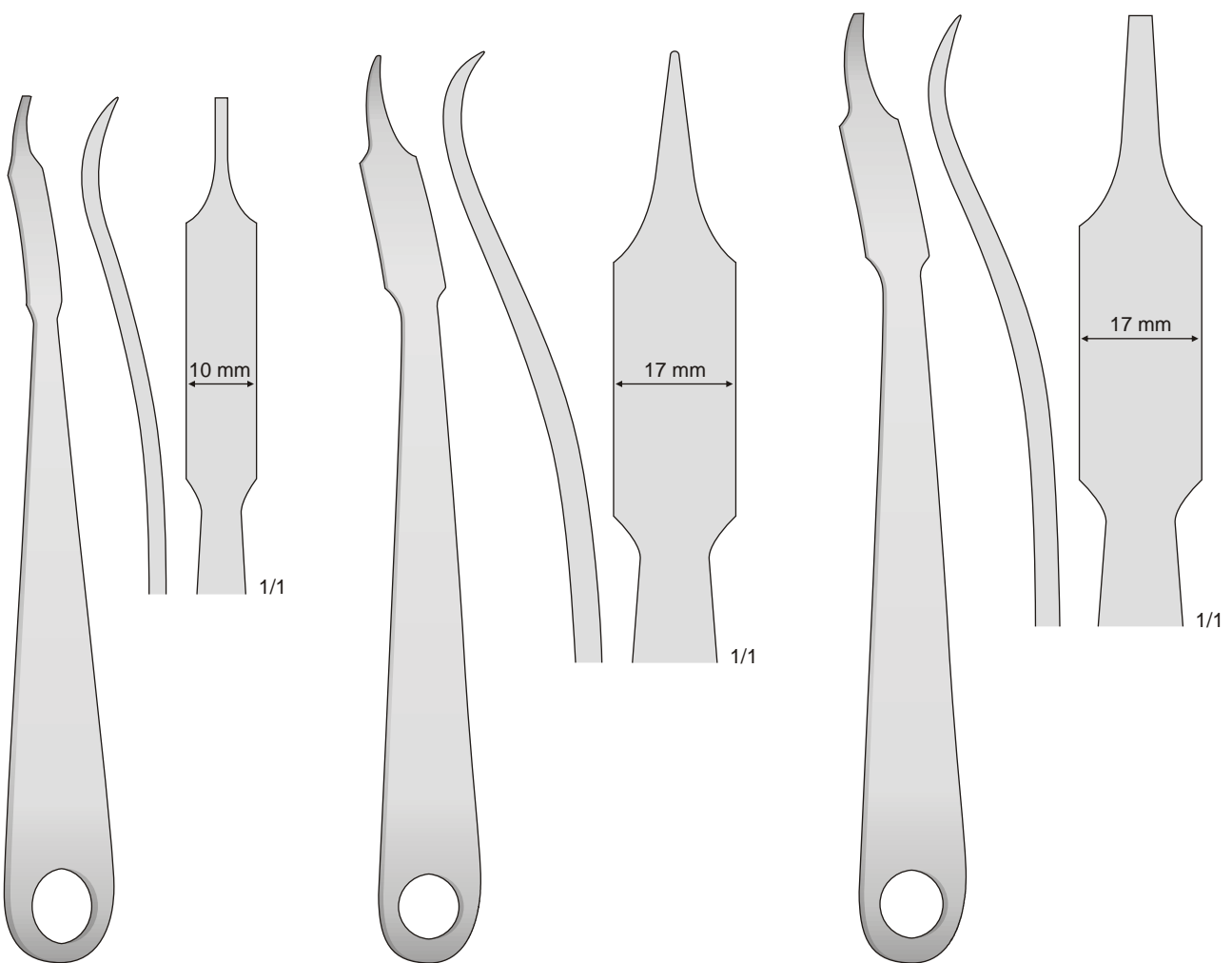

10-540-01
220 mm

10-540-02
240 mm

10-540-03
240 mm

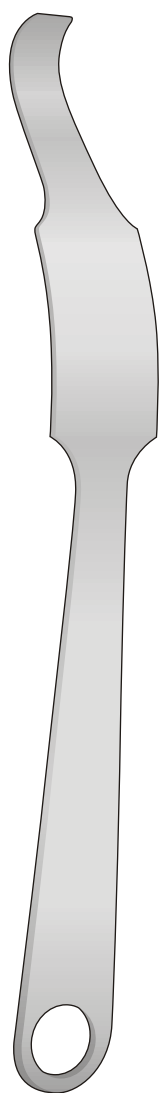

HOHMANN
10-550

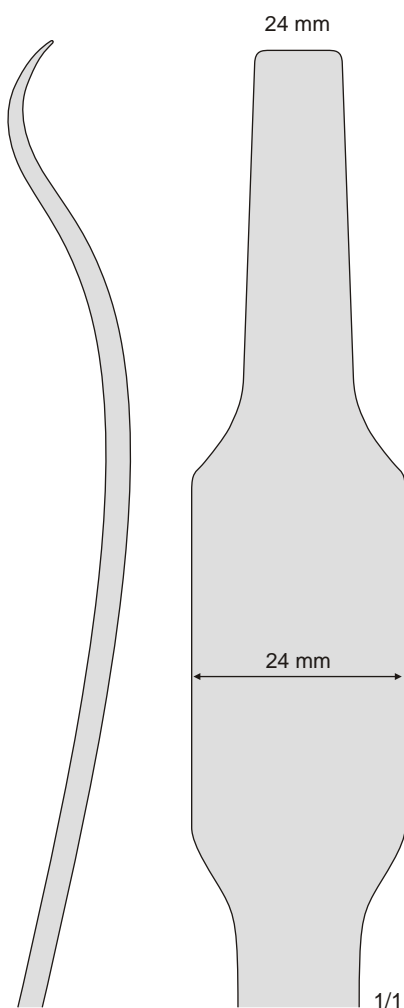

10-550-26
260 mm

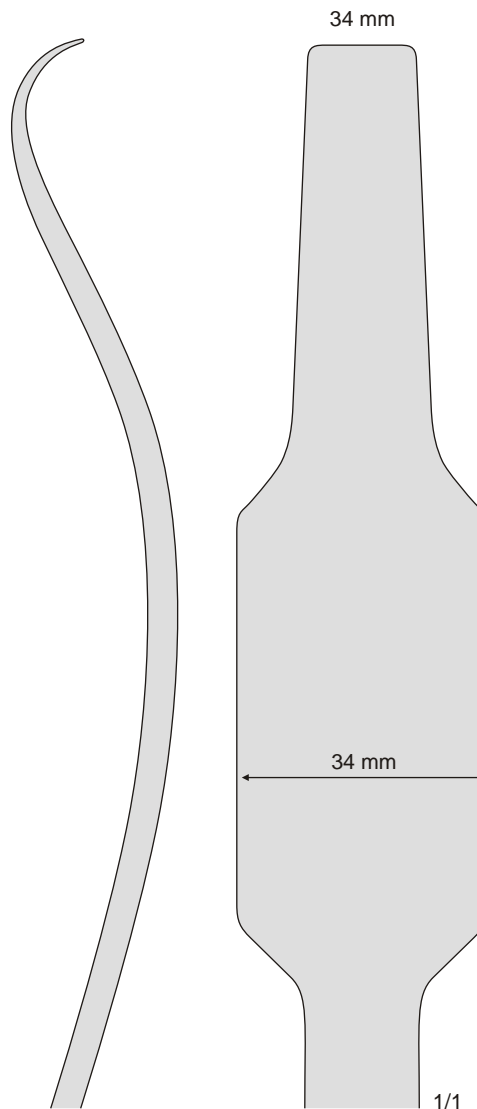

10-550-28
285 mm

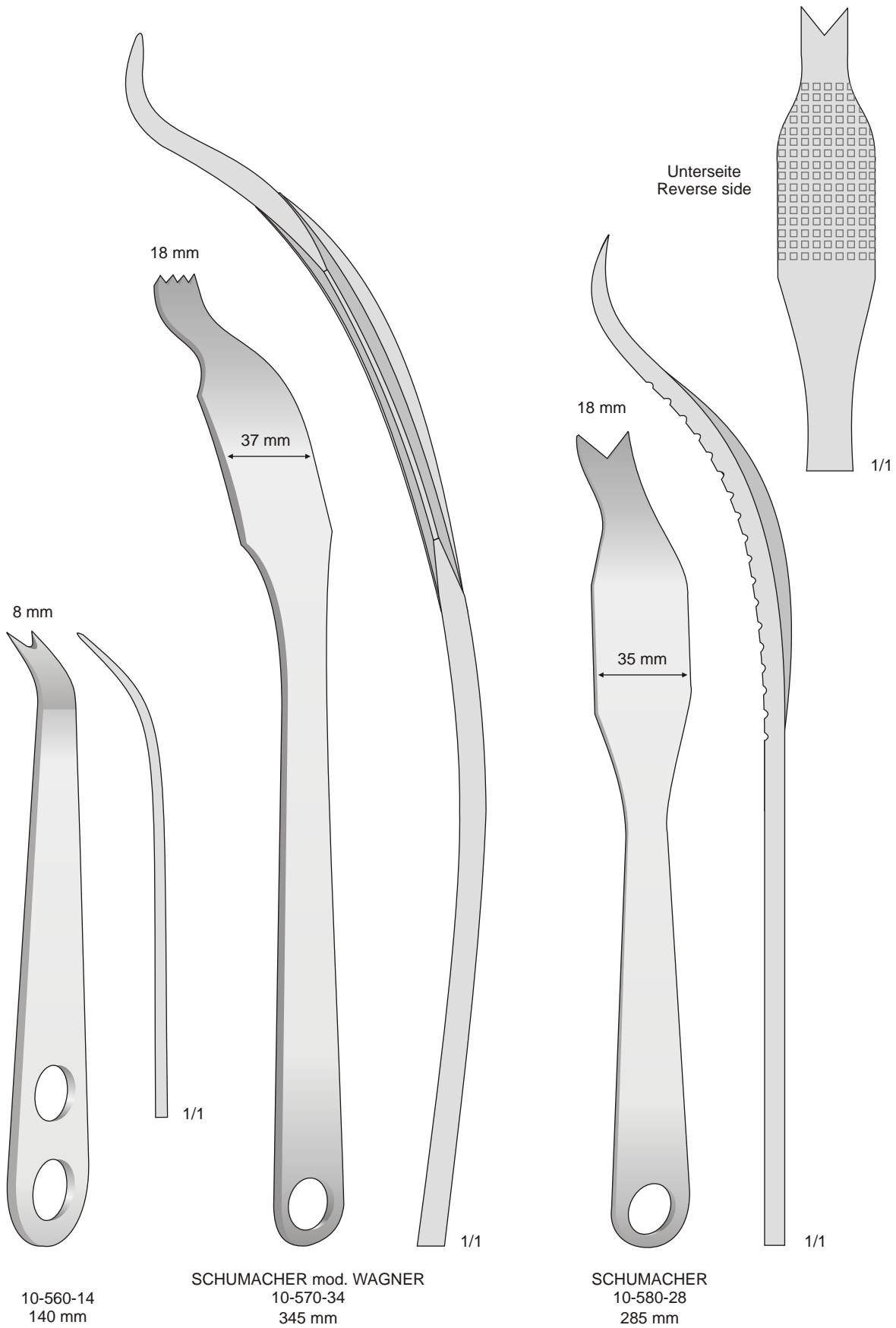

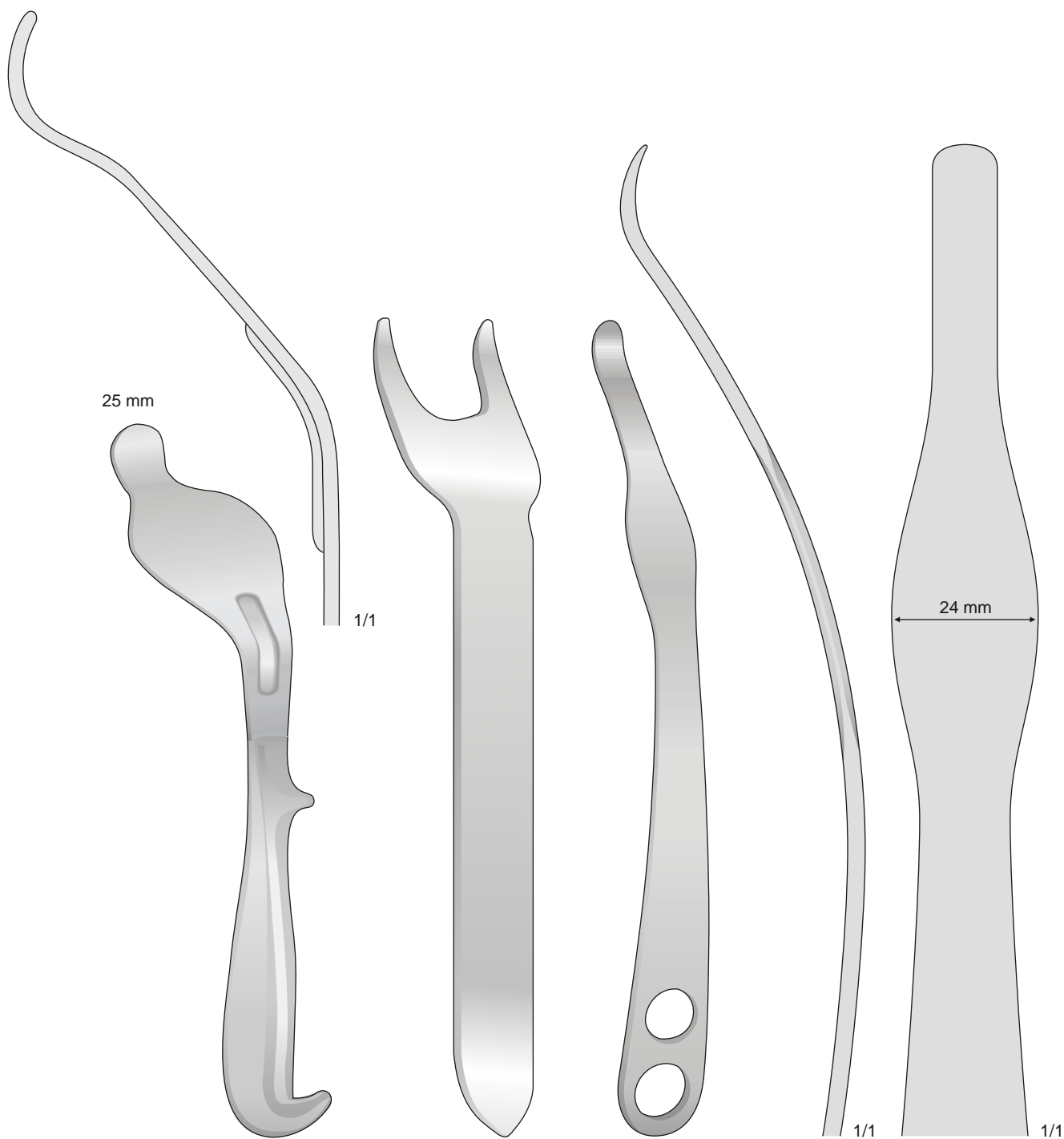

BENNETT
10-590-01 43 mm
10-590-02 60 mm
240 mm

BLOUNT
10-600-26
260 mm

10-610-26
260 mm

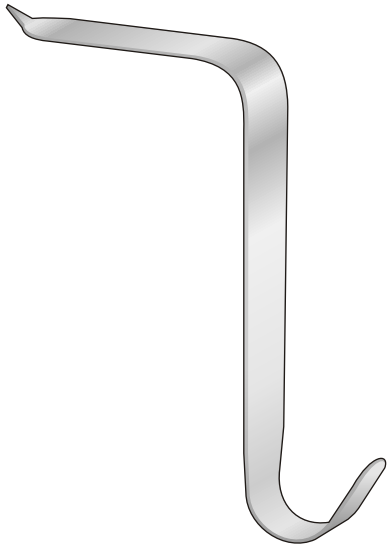

TAYLOR
10-610-01 75 x 30 mm
10-610-02 100 x 30 mm
165 mm

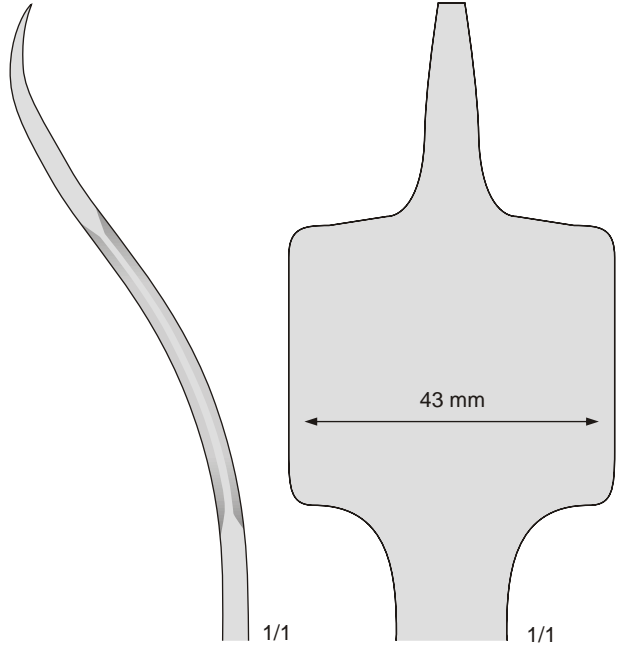

10-630-01
240 mm

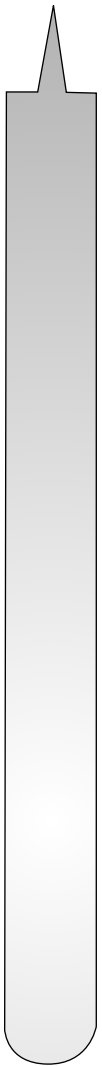

10-620-25
250 mm

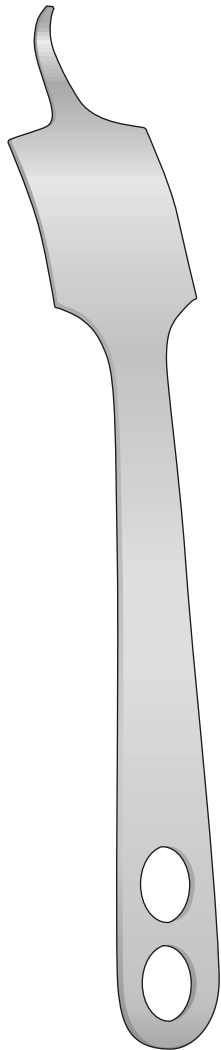
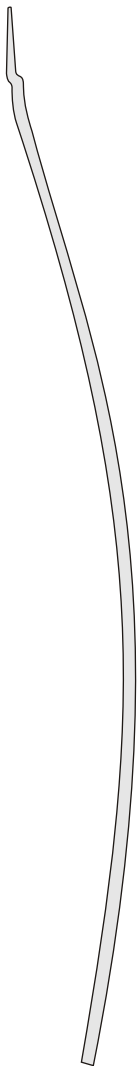

HOHMANN
10-630
240 mm

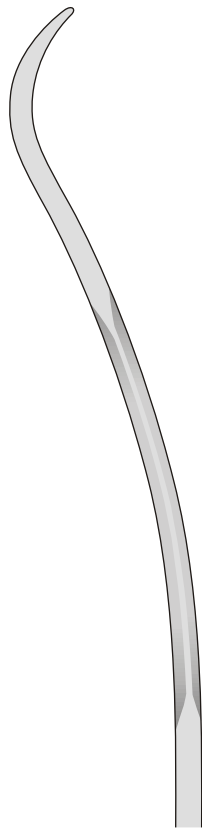

1/1

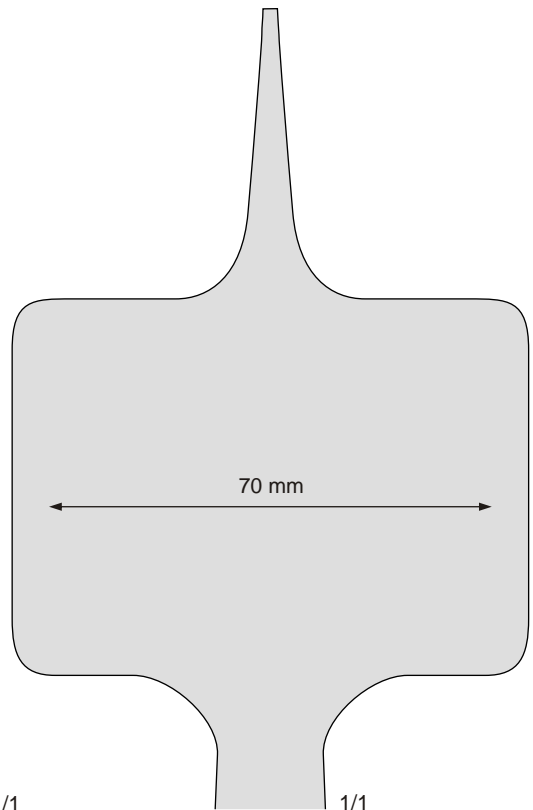

10-630-02
240 mm



10-640-18
185 mm

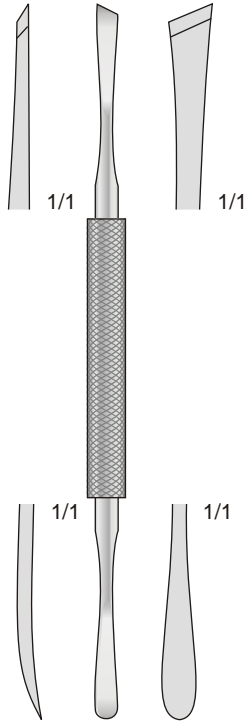

10-650-16
165 mm



ALDERDYCE
10-660-21
210 mm

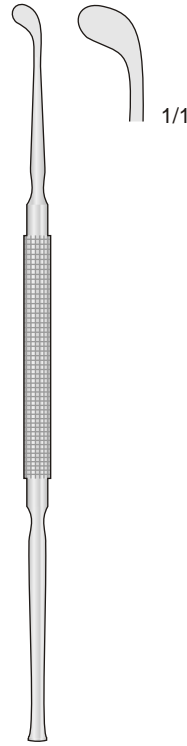

FREER
10-670-19
190 mm

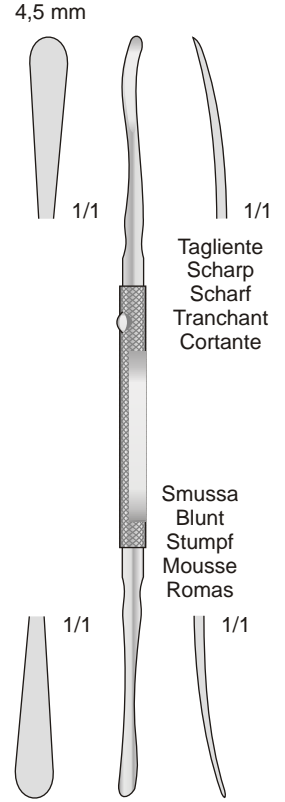

10-680-18
180 mm

Tagliente
Scharp
Scharf
Tranchant
Cortante

Smussa
Blunt
Stumpf
Mousse
Romas

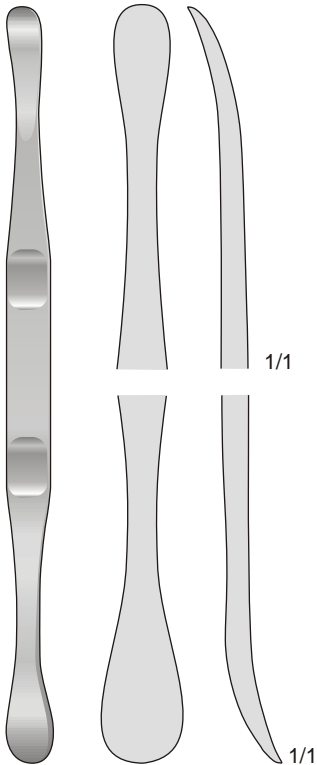

BABBUSH
10-690-18
180 mm

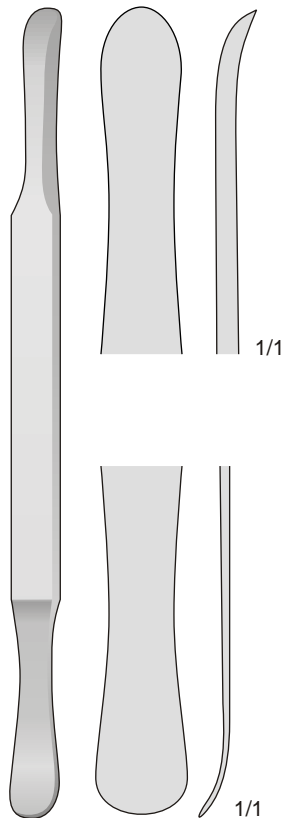

SELDIN
10-700-19
195 mm

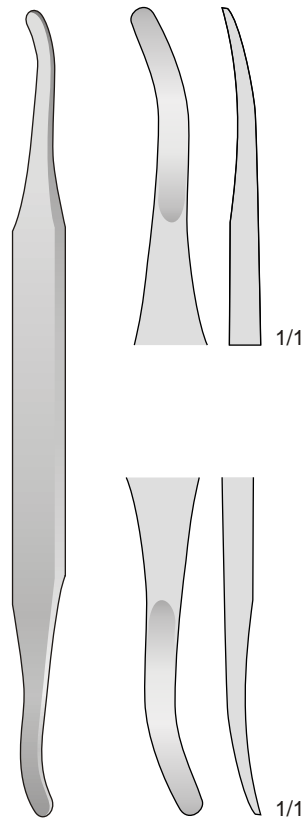

SELDIN
10-710-19
190 mm

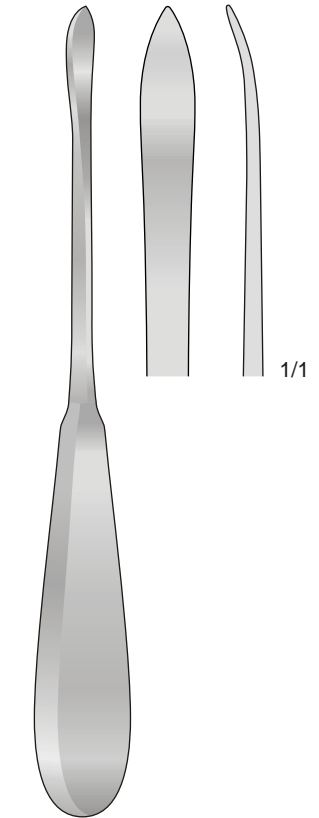

LANGENBECK
10-720-20
200 mm

4 mm

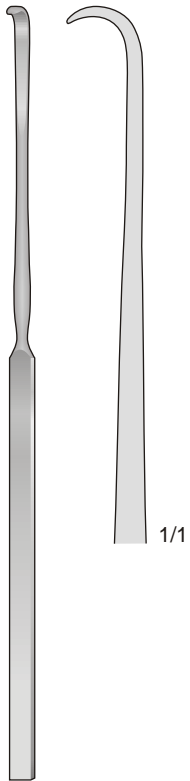

10-730-20
200 mm

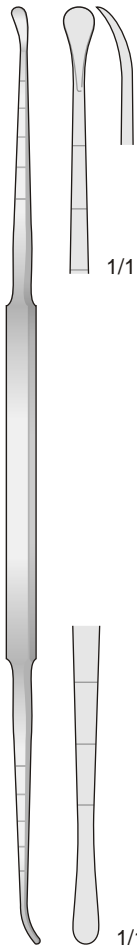

COTTLE
10-740-22
220 mm

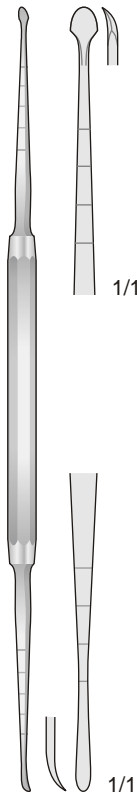

MASING
10-750-21
210 mm

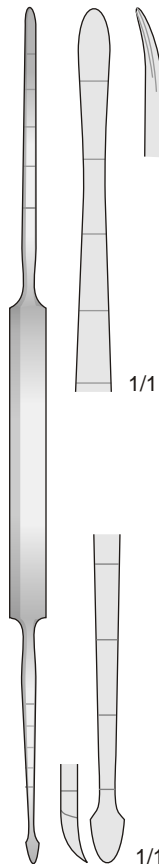

COTTLE
10-760-21
210 mm

5 mm

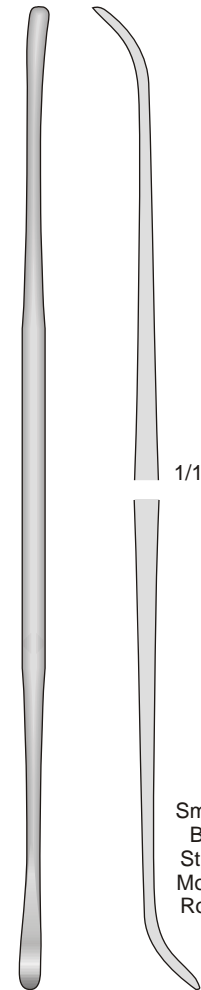

SALZBURG
10-770-24
245 mm

Tagliente
Sharp
Scharf
Tranchant
Cortante

5 mm

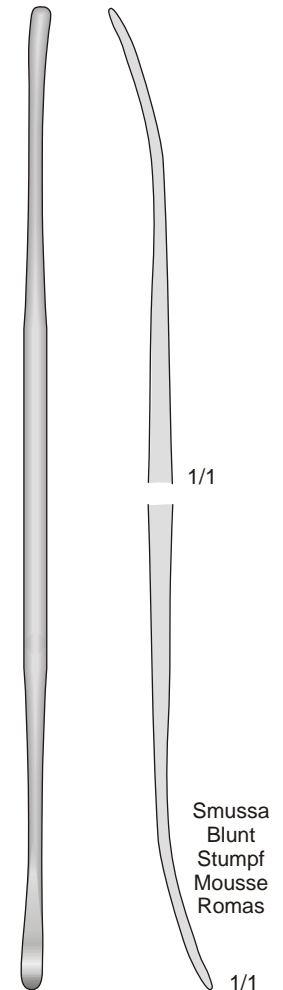

SALZBURG
10-780-24
245 mm

Tagliente
Sharp
Scharf
Tranchant
Cortante

Smussa
Blunt
Stumpf
Mousse
Romas

Smussa
Blunt
Stumpf
Mousse
Romas

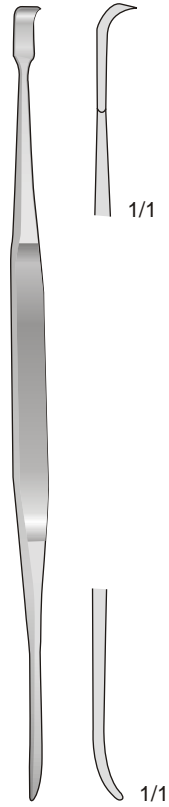

HOWARTH
10-790-21
210 mm

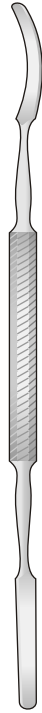

MC DONALD
10-800-19
190 mm

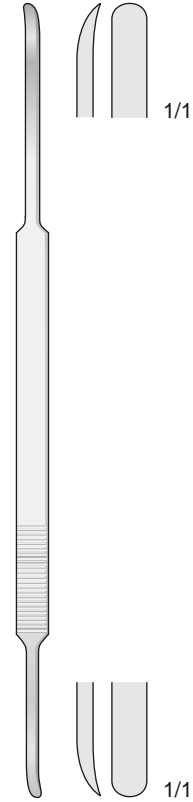

MCKENTY
10-810-22
220 mm

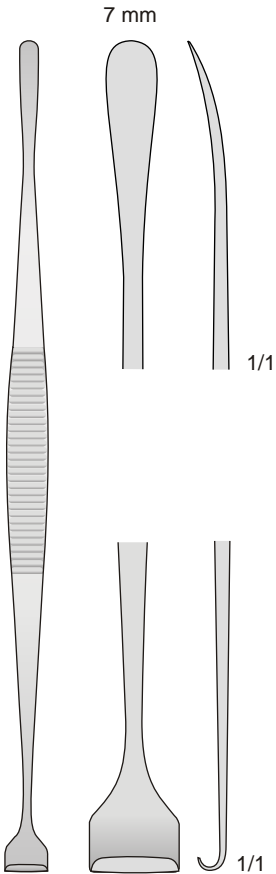

HURD
10-820-01
220 mm

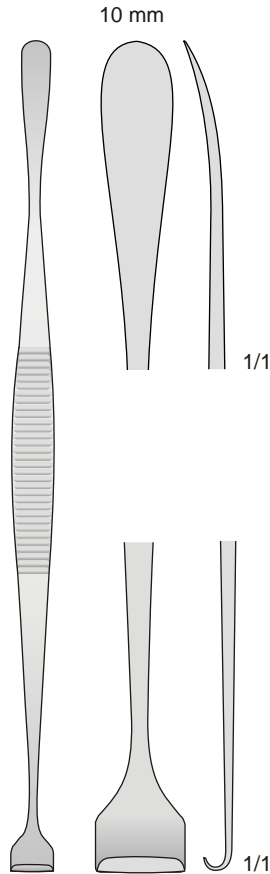

HURD
10-820-02
220 mm

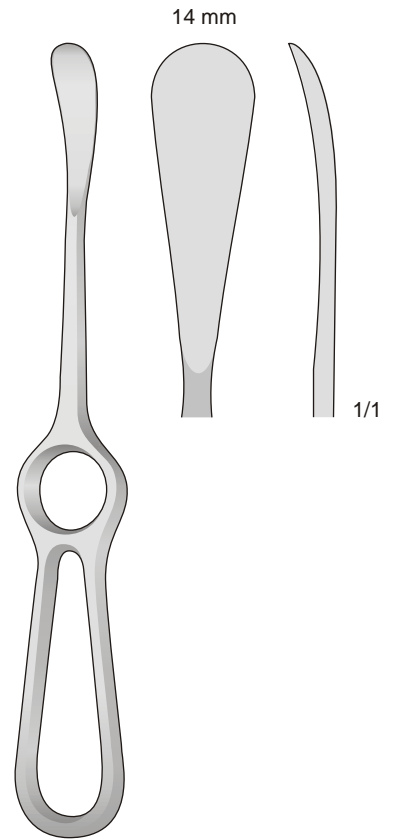

SEDILLOT
10-830-21
210 mm

Periosteal elevators
Taglienti
Sharp
Scharf
Tranchant
Cortante

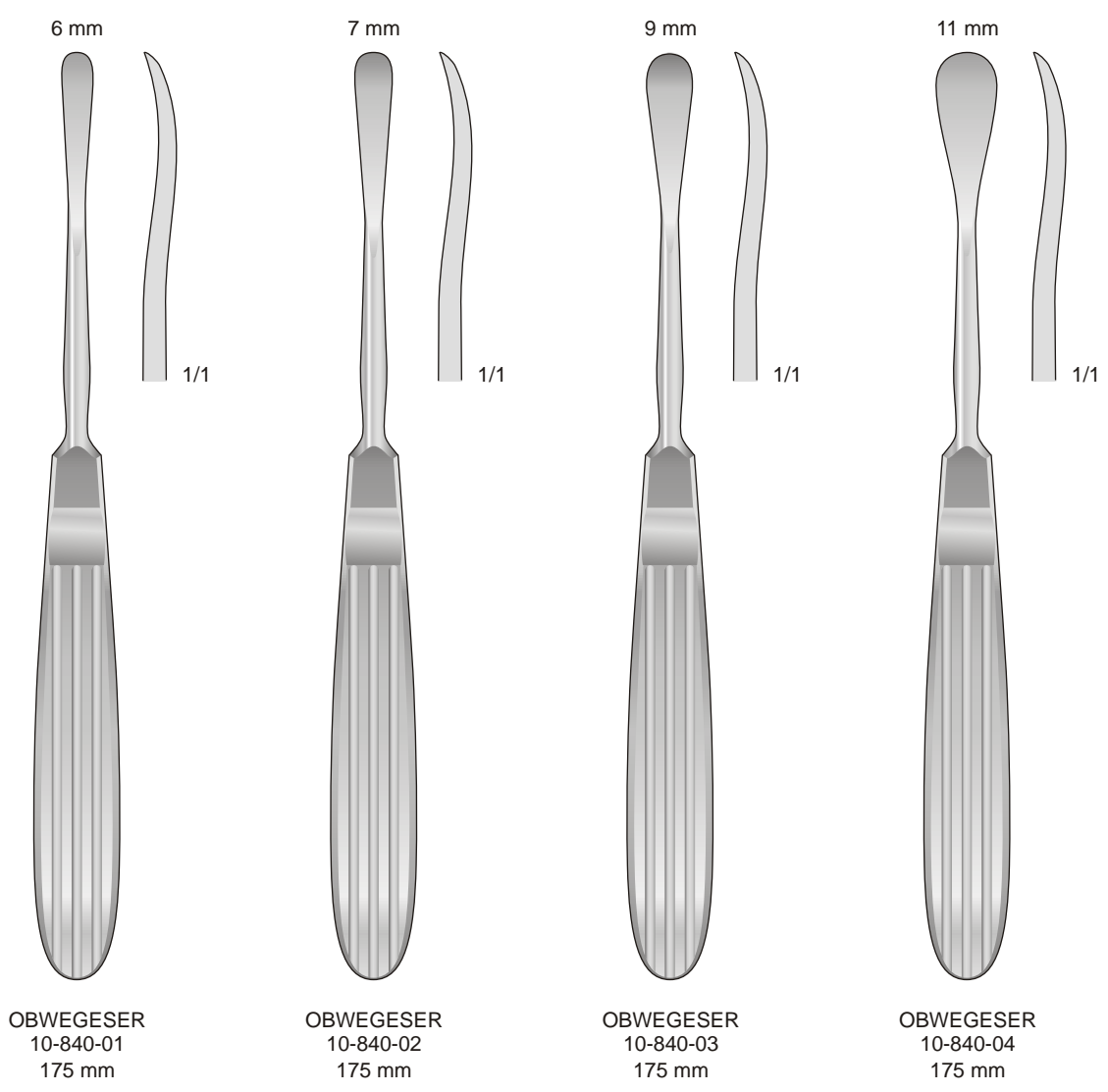

Sinistra, tagliente
Left, sharp
Links, Scharf
À gauche, tranchant
A la izquierda, cortante

Destra, tagliente
Right, sharp
Rechts, Scharf
À droite, tranchant
A la derecha, cortante

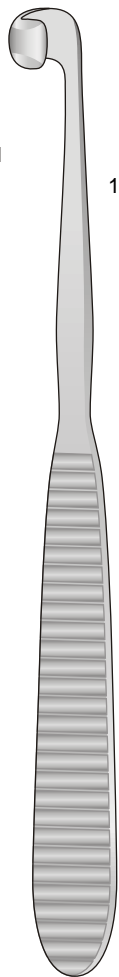

OBWEGESER
10-850
190 mm

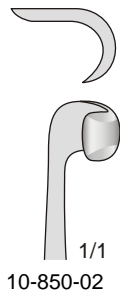

5 mm

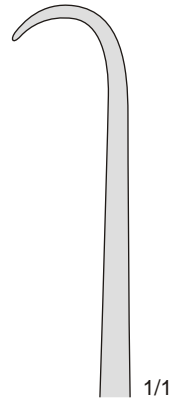

10-860-01
200 mm

7 mm

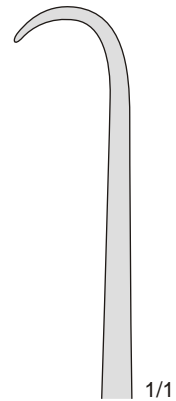

10-860-02
200 mm

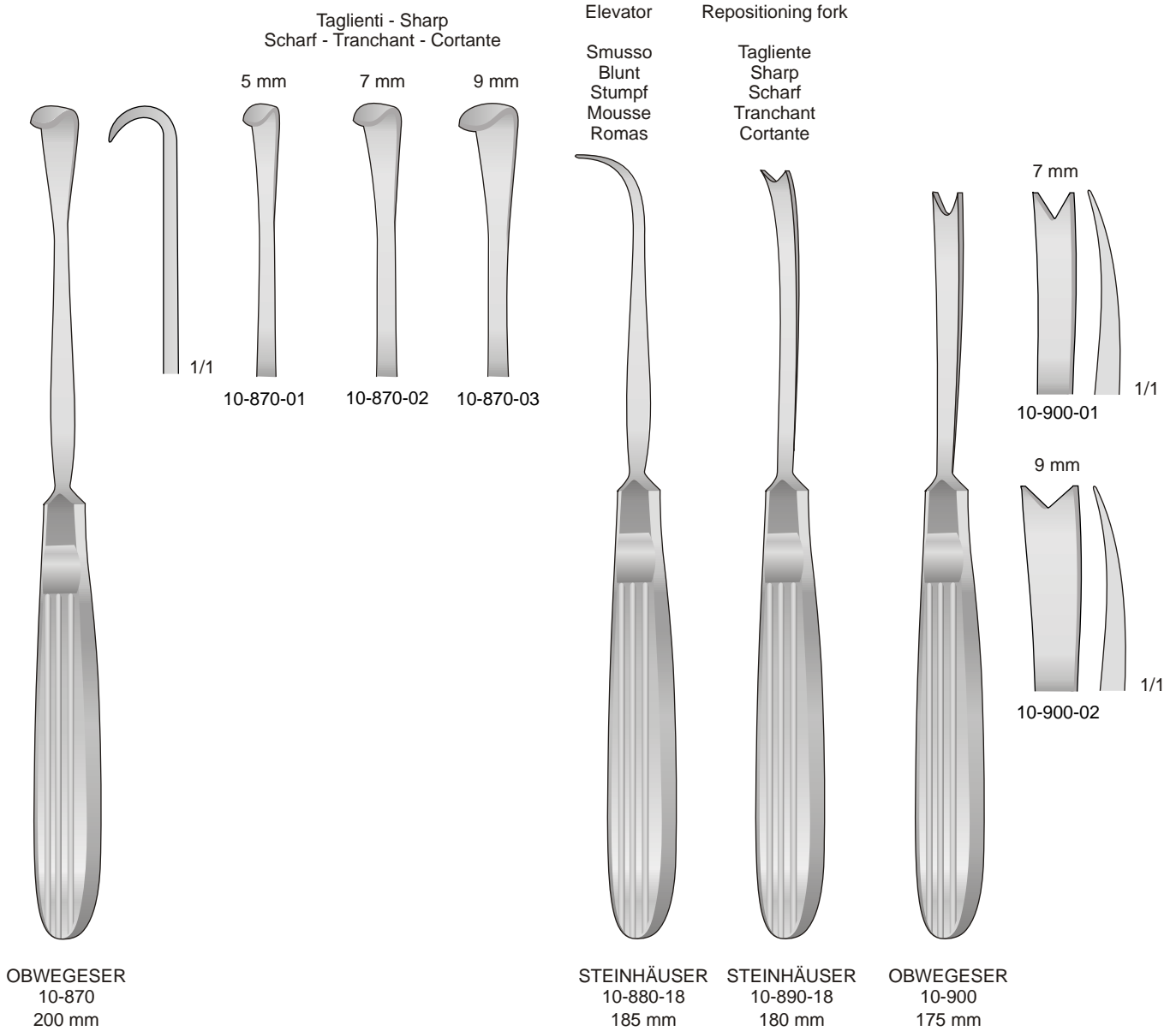

15 mm



CUSHING
10-910-19
190 mm

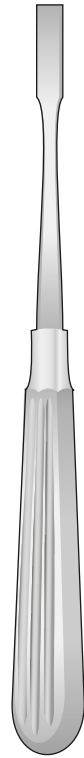

ADSON
10-920
170 mm

8 mm

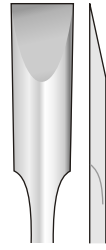

10-920-01

7 mm



10-920-02

7 mm



10-920-03

7 mm



10-920-04

2,5 mm

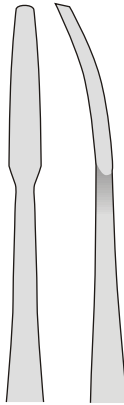

1/1

JOSEPH
10-930-01
170 mm

7 mm

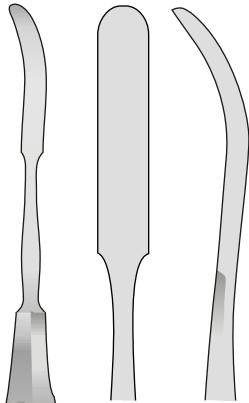

1/1

JOSEPH
10-930-02
180 mm

10 mm



MOLT
10-940-16
160 mm

10 mm



1/1

12 mm



1/1

15 mm

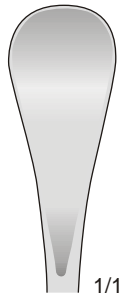

1/1

HENAHAN
10-950
175 mm

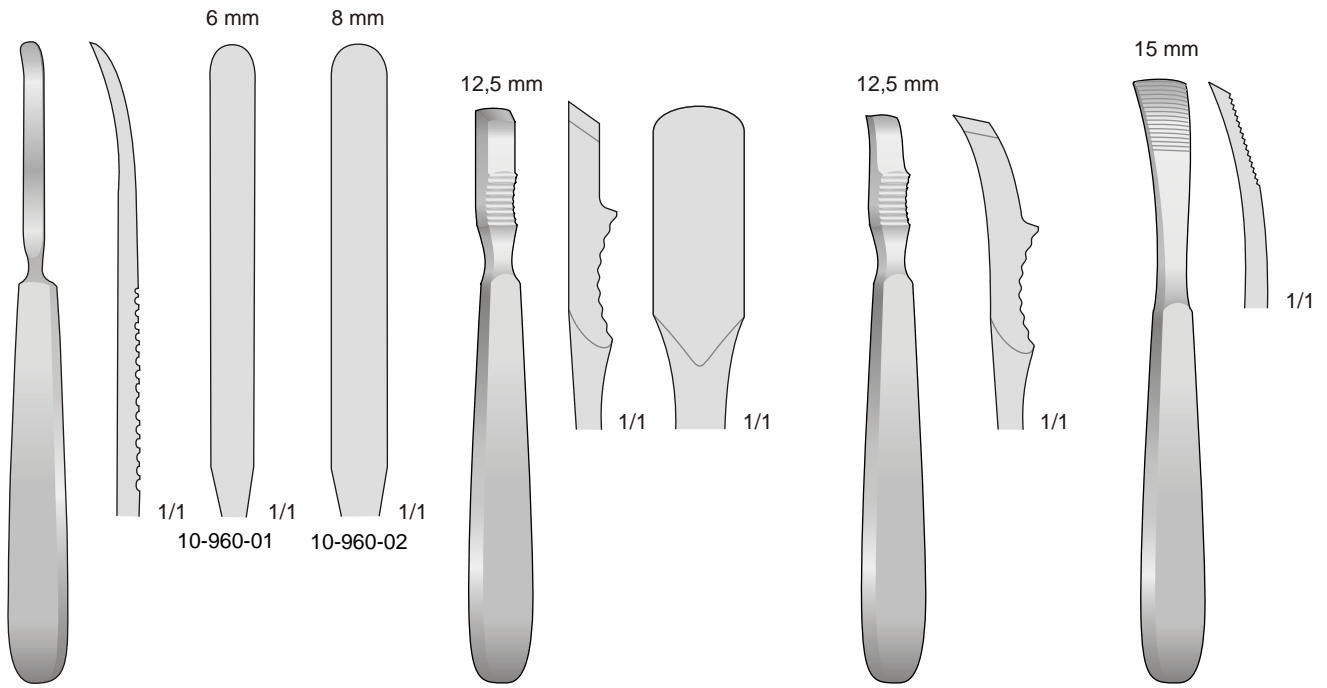

10-960
170 mm

FARABEUF
10-970-16
150 mm

FARABEUF
10-980-15
150 mm

JANSEN
10-990-16
165 mm

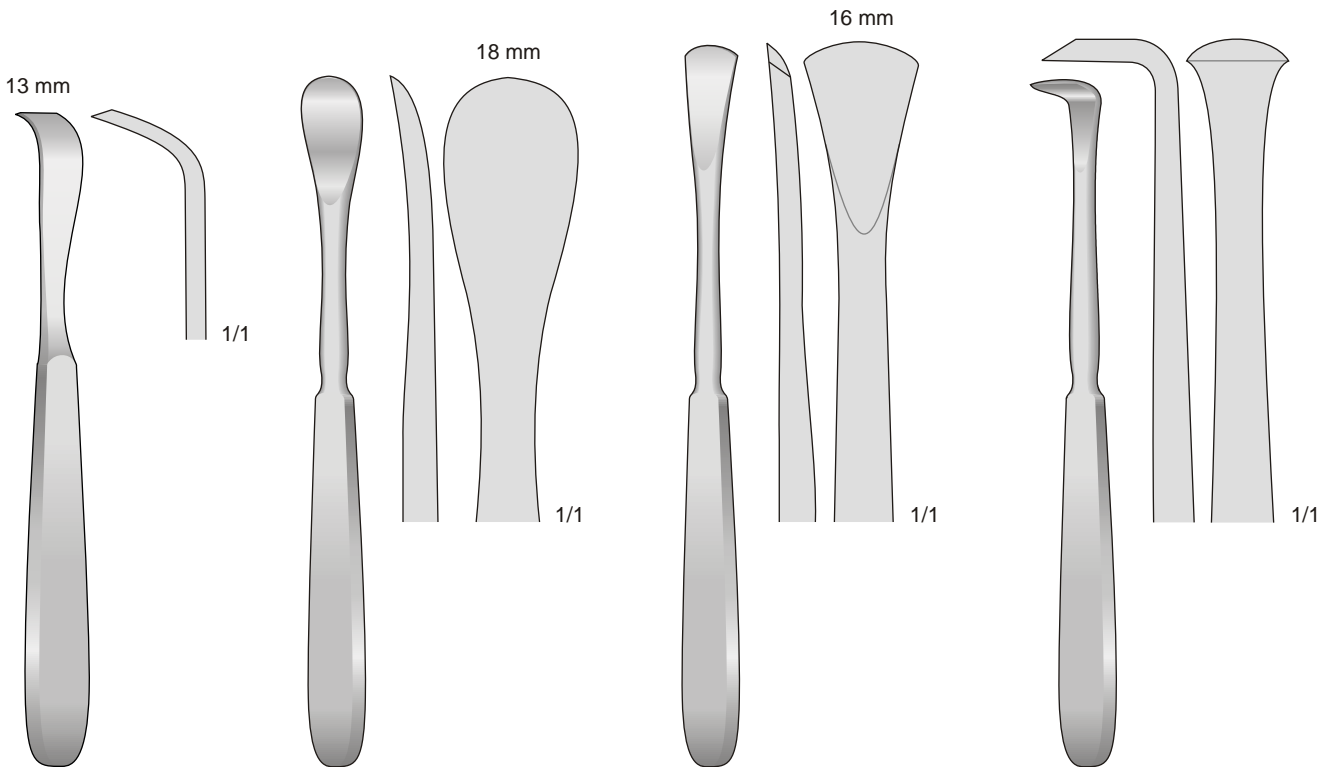

SCHNEIDER
10-1000-17
175 mm

SEDILLOT
10-1010-18
185 mm

LANGENBECK
10-1020-19
190 mm

LANGENBECK
10-1030-18
180 mm

Sinus
Hipophisectomia

Sinus and
Hypophisectomy

Sinus und
Hypophisectomie

Elevation e dissezion
de apofisi zigomatica

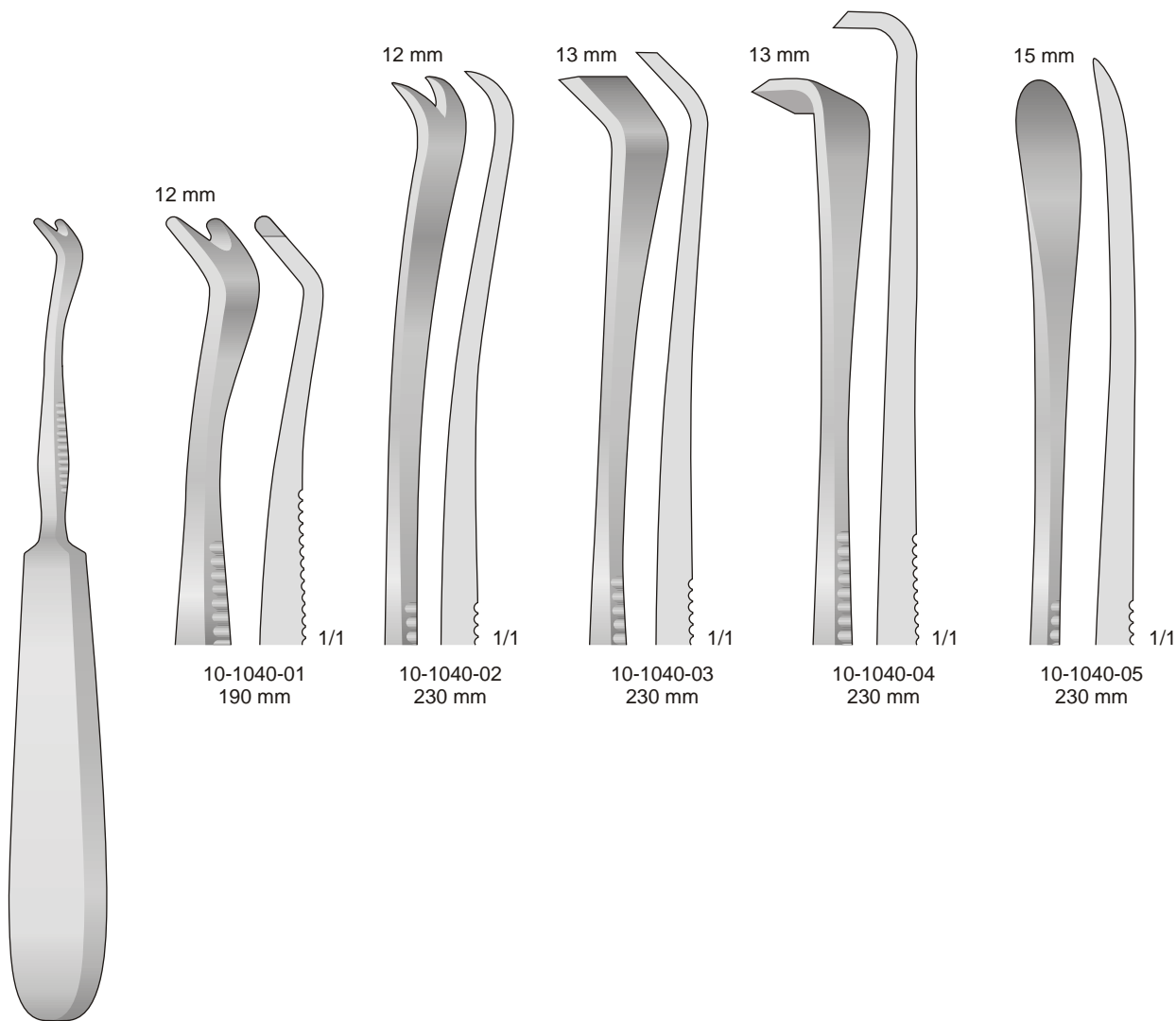

SEMB
10-1040

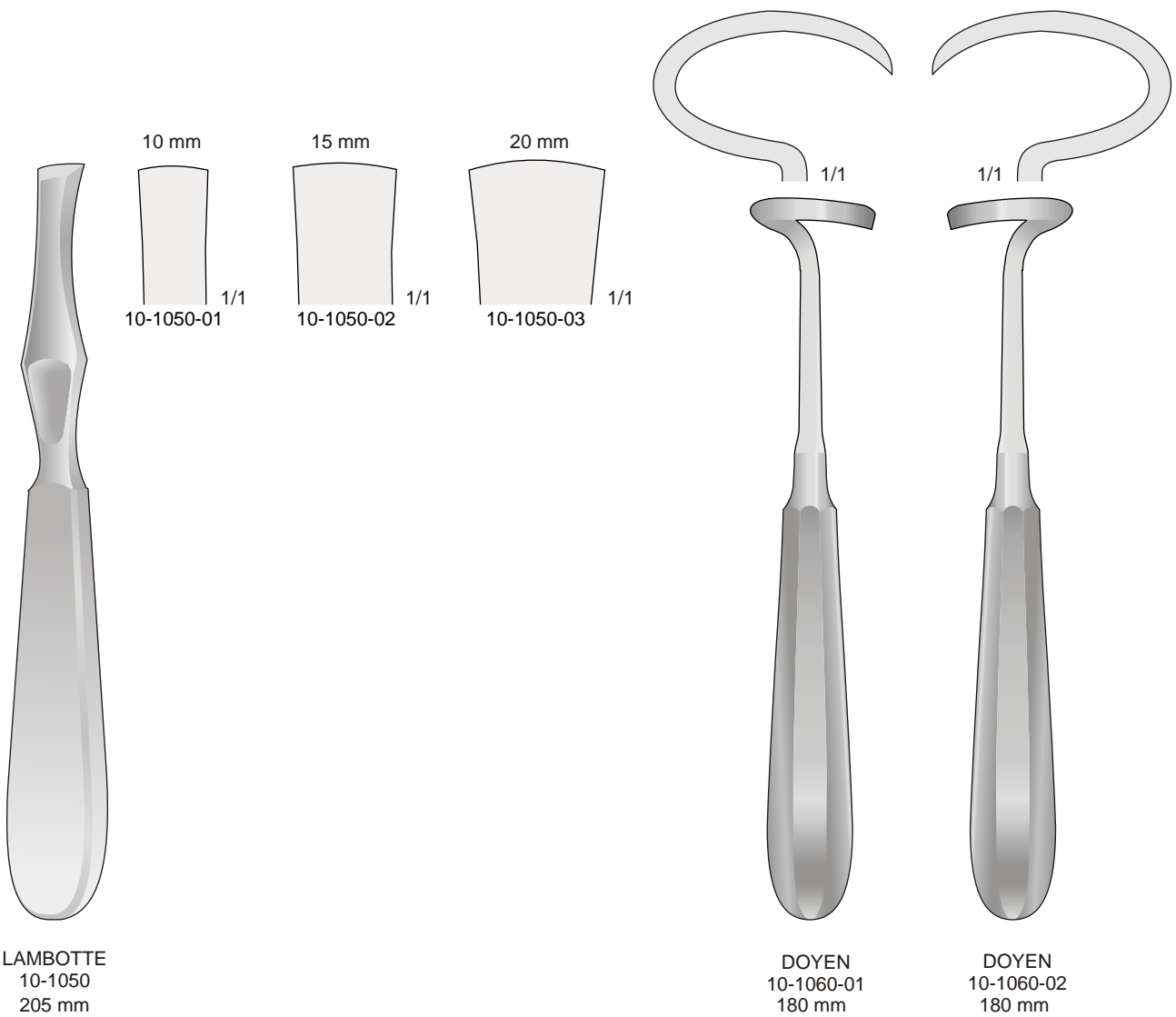

Con manico Ferrozell
With Ferrozell handle
Mit Ferrozellgriff
Avec poignée en Ferrozell
Con mango de Ferrozell

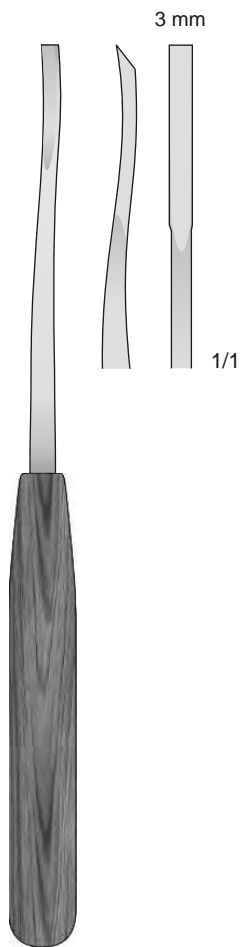

10-1070-01
180 mm

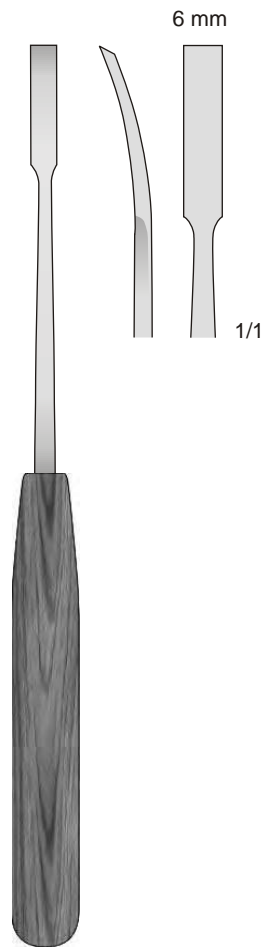

10-1070-02
190 mm

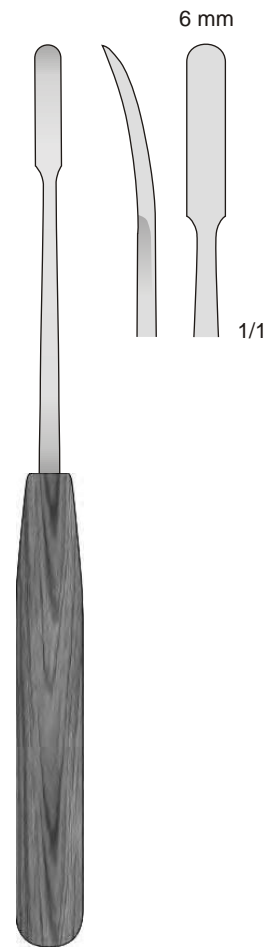

10-1070-03
190 mm

Con manico Ferrozell
With Ferrozell handle
Mit Ferrozellgriff
Avec poignée en Ferrozell
Con mango de Ferrozell

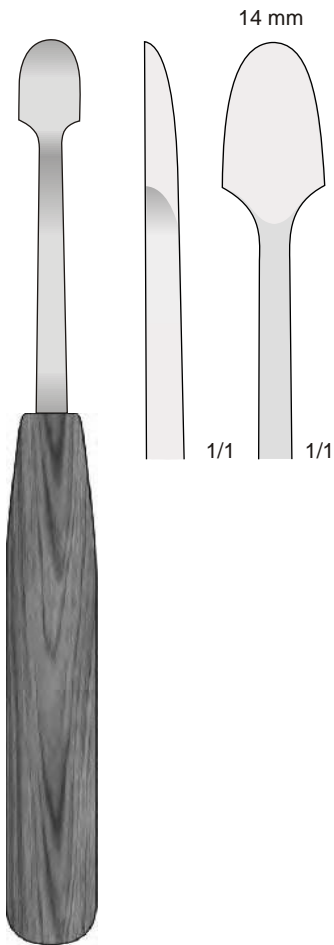

10-1080-01
200 mm

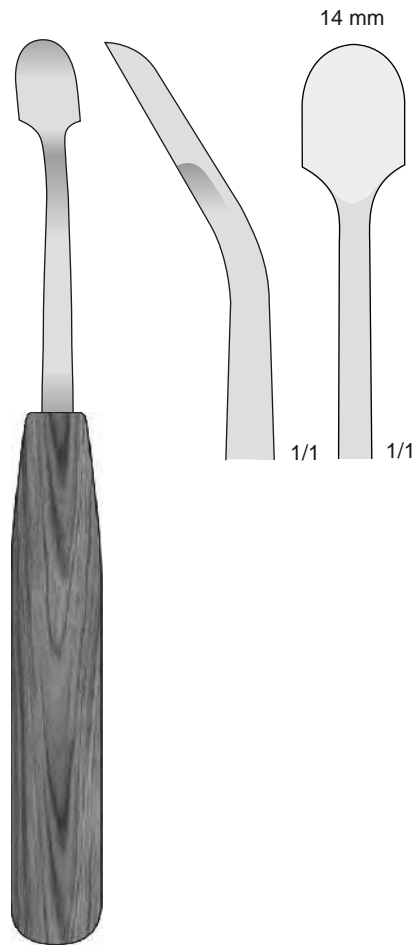

10-1090-20
200 mm

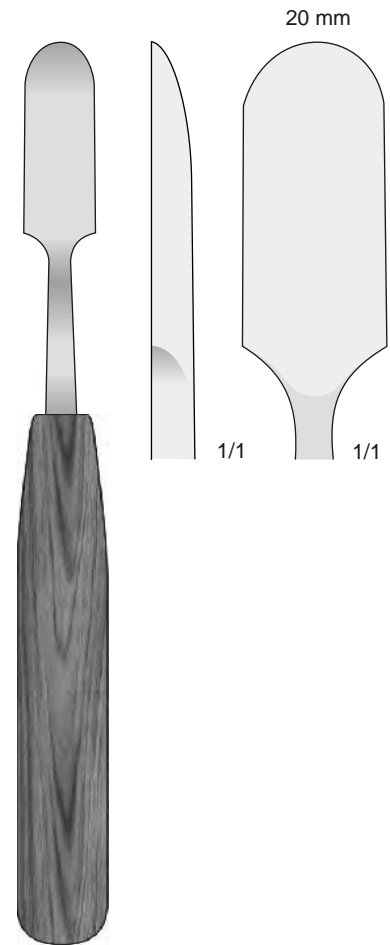

10-1080-02
200 mm

Con manico Ferrozell
With Ferrozell handle
Mit Ferrozellgriff
Avec poignée en Ferrozell
Con mango de Ferrozell

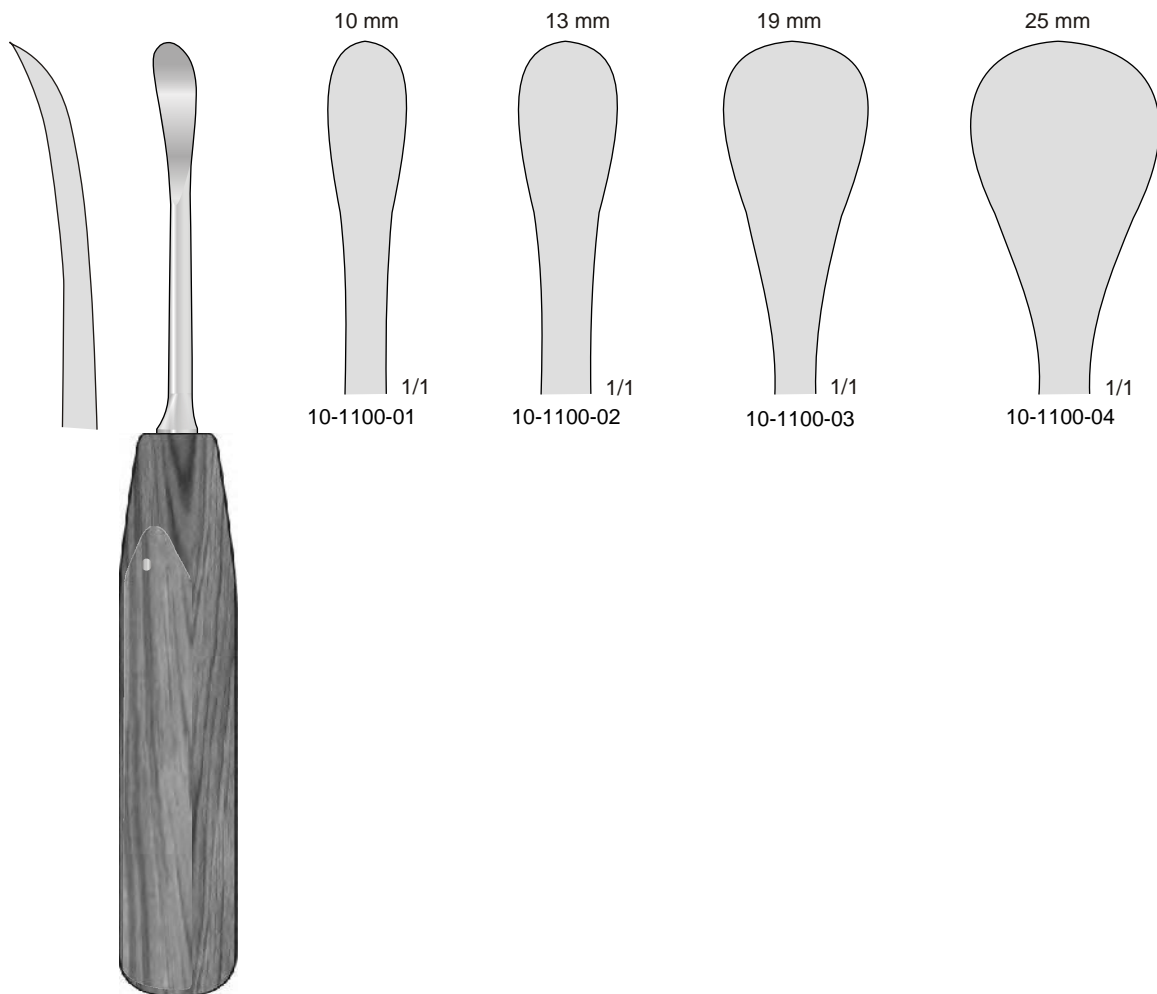

COBB
10-1100
250 mm

Fig. 67

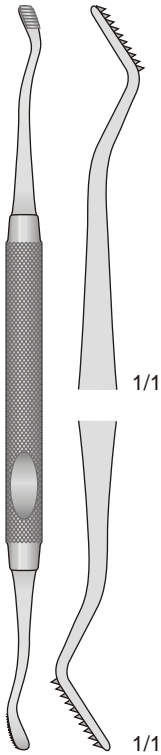

HOWARD
10-1110-18
180 mm

Fig. 45

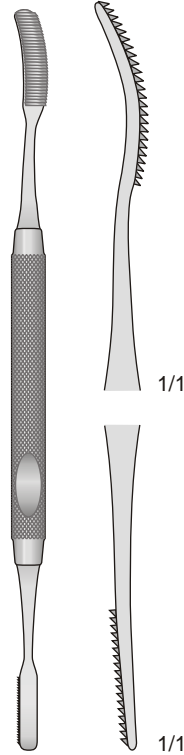

MILLER
10-1120-01
185 mm

Fig. 52

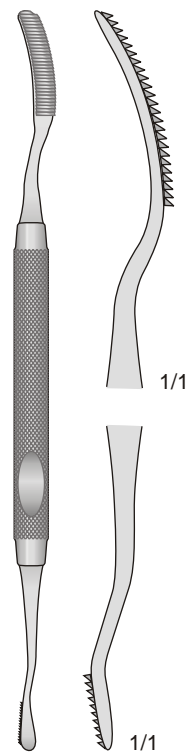

MILLER
10-1120-02
180 mm

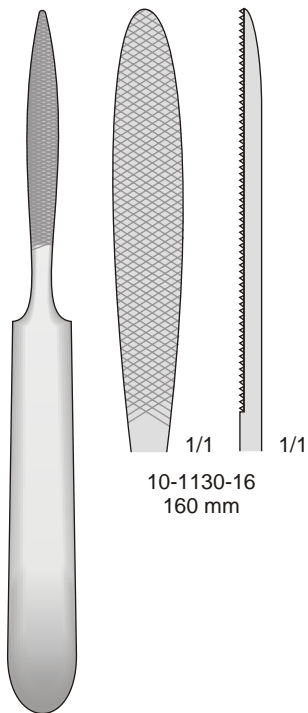

JOSEPH
10-1130
160 mm

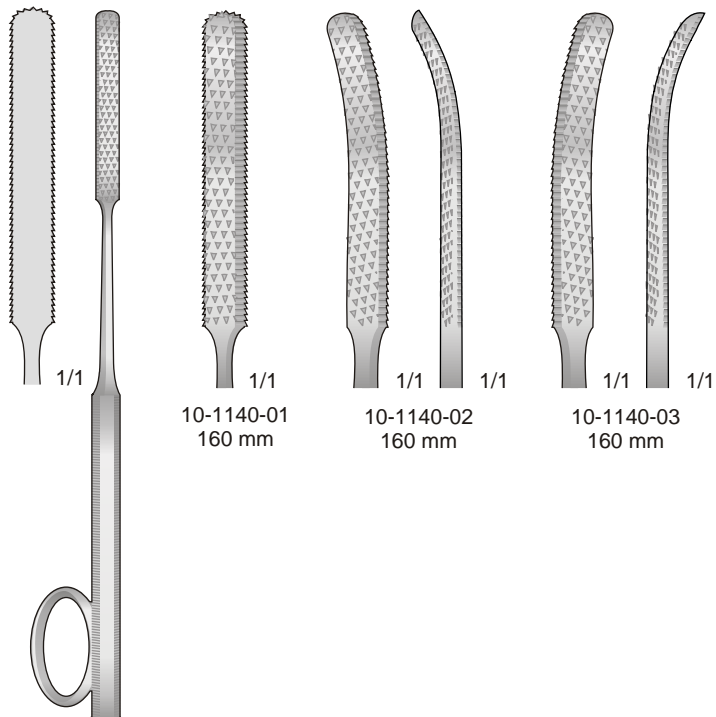

GALLAHER
10-1140
160 mm

10-1130-16
160 mm

10-1140-01
160 mm

10-1140-02
160 mm

10-1140-03
160 mm

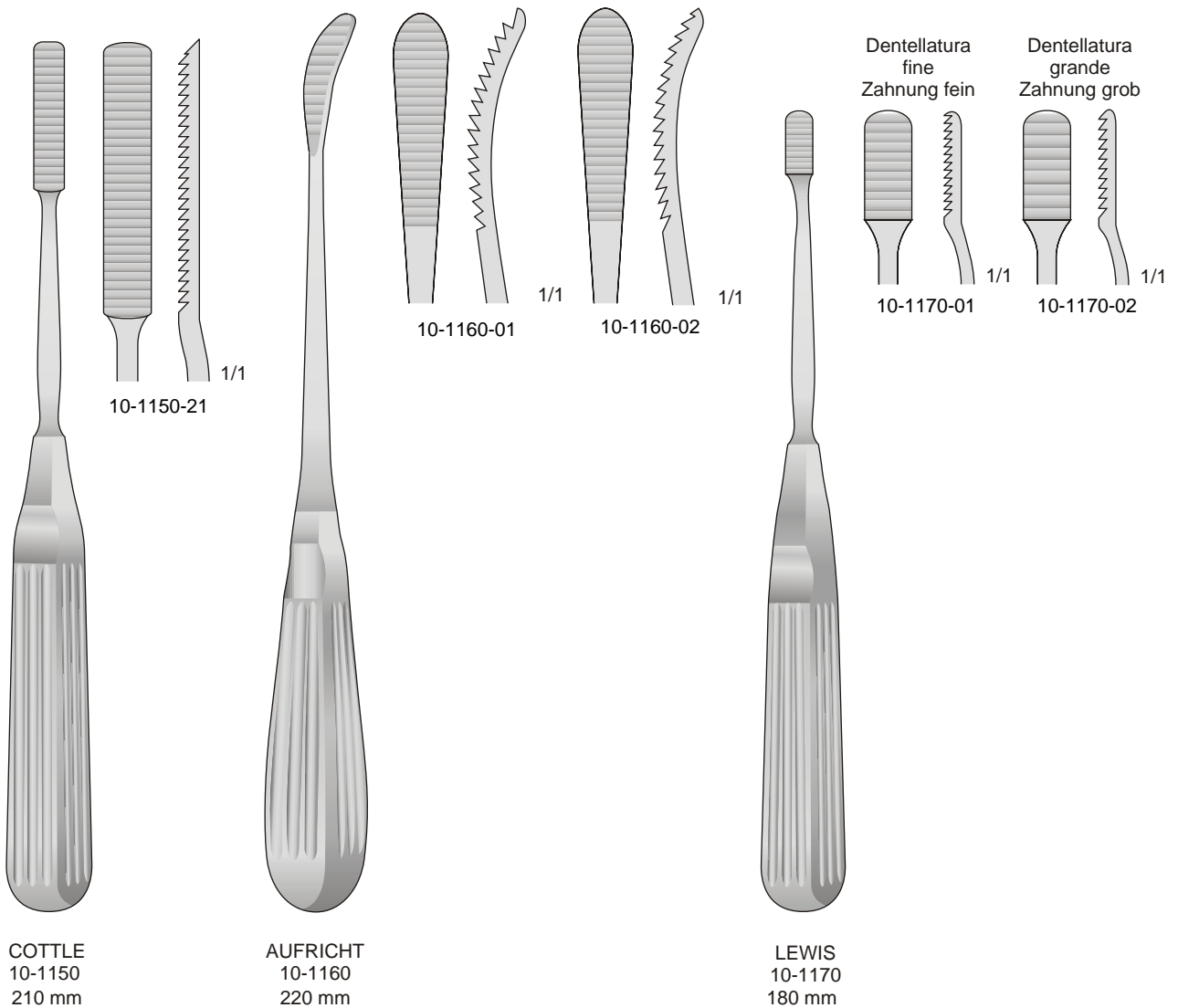

TC

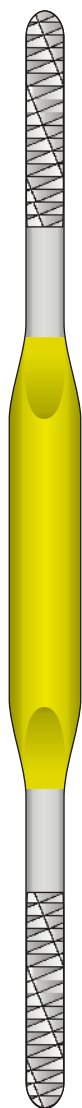

FOMON
10-1180
200 mm

TC



1



3



5

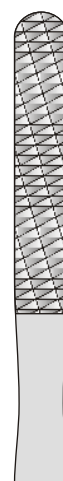

7

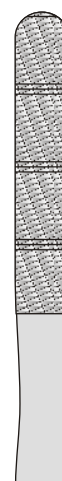

9



2



4



6

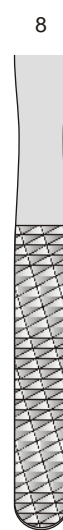

8



10

10-1180-01

10-1180-02

10-1180-03

10-1180-04

10-1180-05

8 mm



8 mm

10-1190-01
210 mm

2 mm



5 mm

10-1190-02
210 mm



1/1



1/1

8 mm



8 mm

10-1200-01
210 mm

8 mm



8 mm

10-1200-02
210 mm

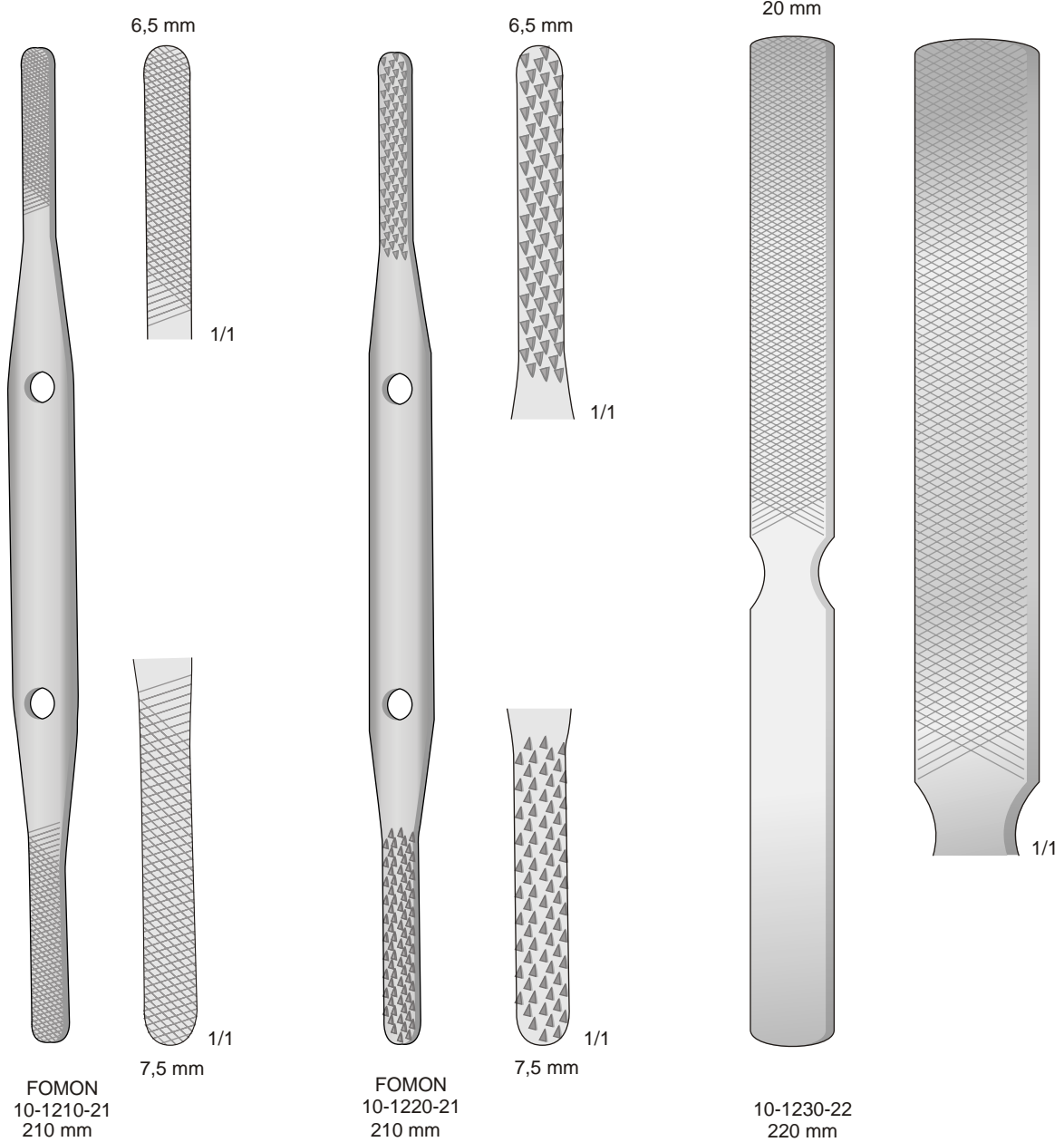

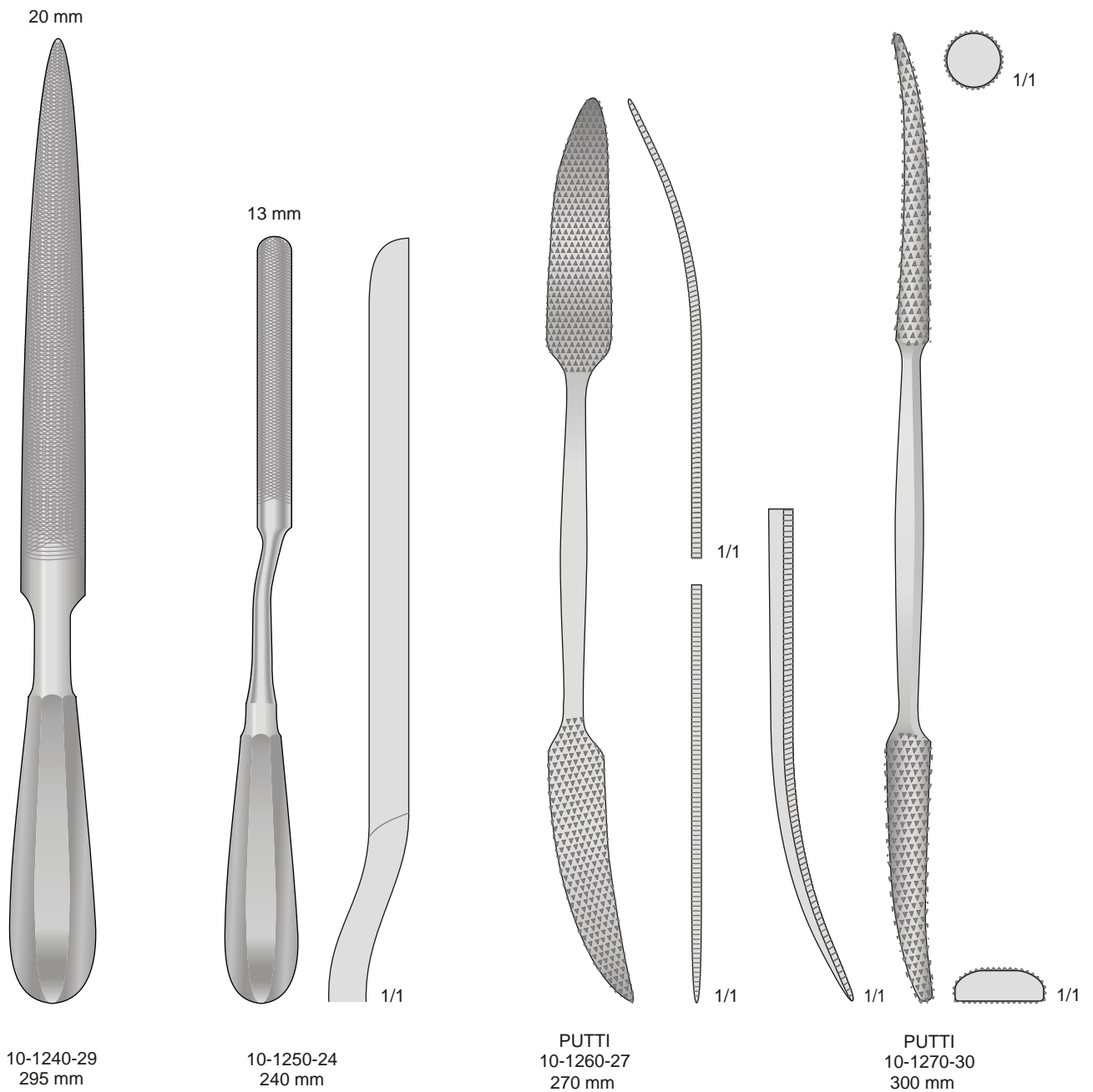

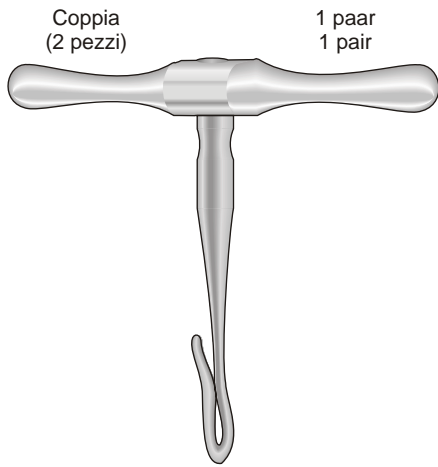

Coppia
(2 pezzi)

1 paar
1 pair

GIGLI
10-1280

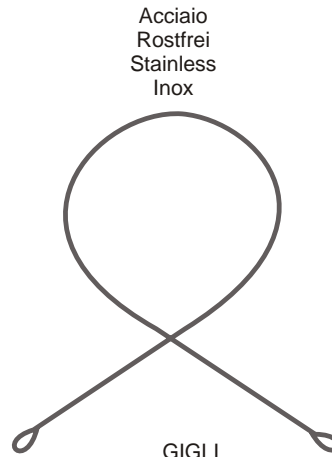

Acciaio
Rostfrei
Stainless
Inox

GIGLI
10-1290-01
300 mm
10-1290-02
500 mm

10-1310
Completa con 3 seghe
Complete with 3 saws
Komplett mit 3 Sägen
Complet avec 3 scies
Completo con 3 sierras

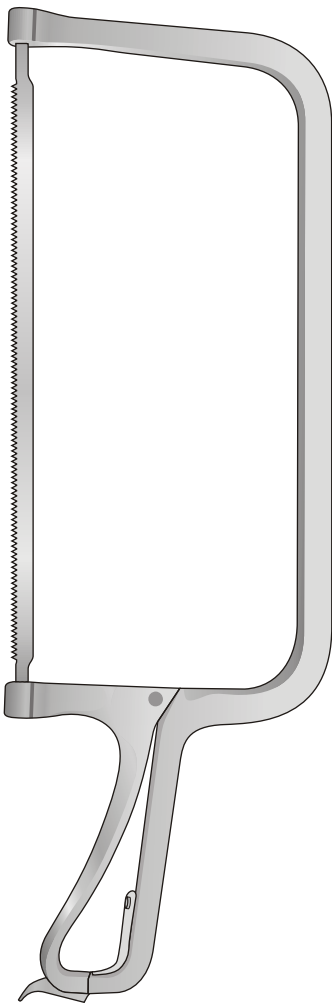

COLLIN
10-1300
390 mm

Fig.1

Fig.2

Fig.3



10-1300-01
280 mm

10-1300-02
280 mm

10-1300-03
280 mm

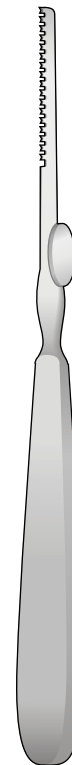

LINDEMANN
10-1320
200 mm



1/1



LANGENBECK
10-1330
235 mm

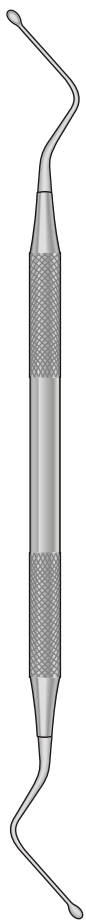

HEMINGWAY
10-1340-01
175 mm

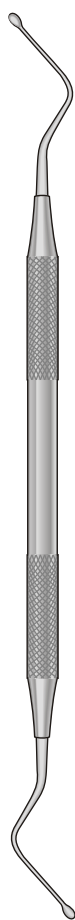

HEMINGWAY
10-1340-02
175 mm

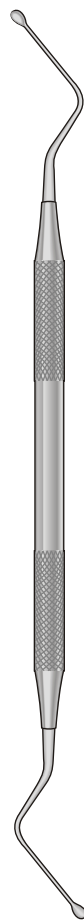

HEMINGWAY
10-1340-03
175 mm

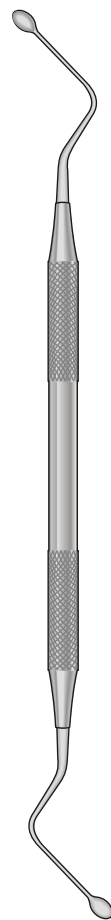

HEMINGWAY
10-1350-01
175 mm

Fig. 1

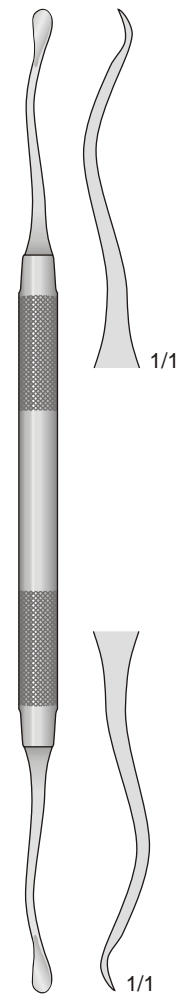

10-1350-02
200 mm

Fig. 2

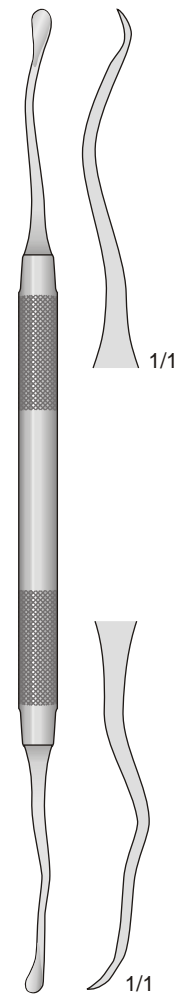

10-1350-03
195 mm

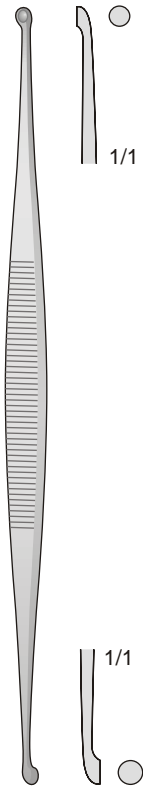

MARTINI
10-1360-14
140 mm

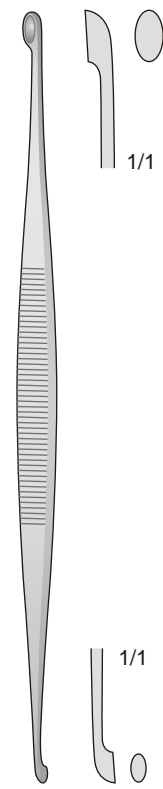

WILLIGER
10-1370-14
145 mm

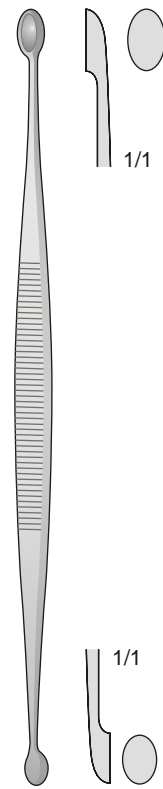

JACOBSON
10-1380-14
140 mm

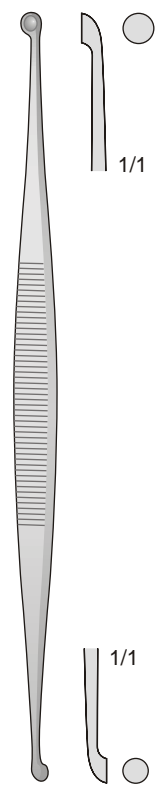

MARTINI
10-1390-14
140 mm

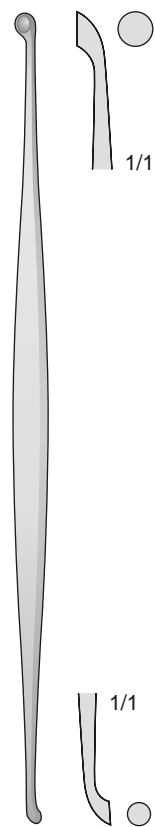

JANSEN
101400-16
160 mm

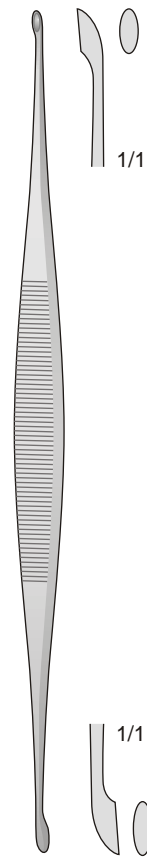

BARTH
10-1410-18
180 mm

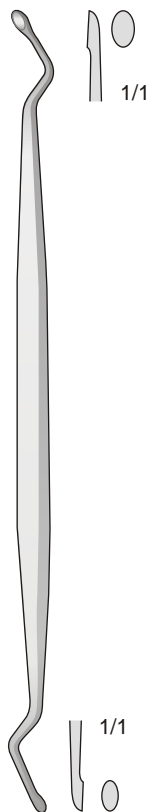

10-1420-01
160 mm

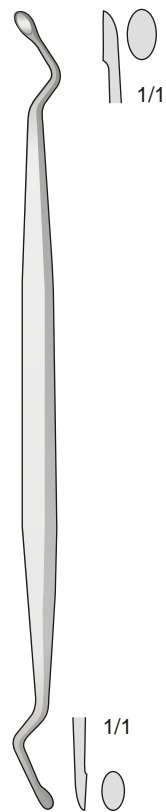

JANSEN
10-1420-02
160 mm

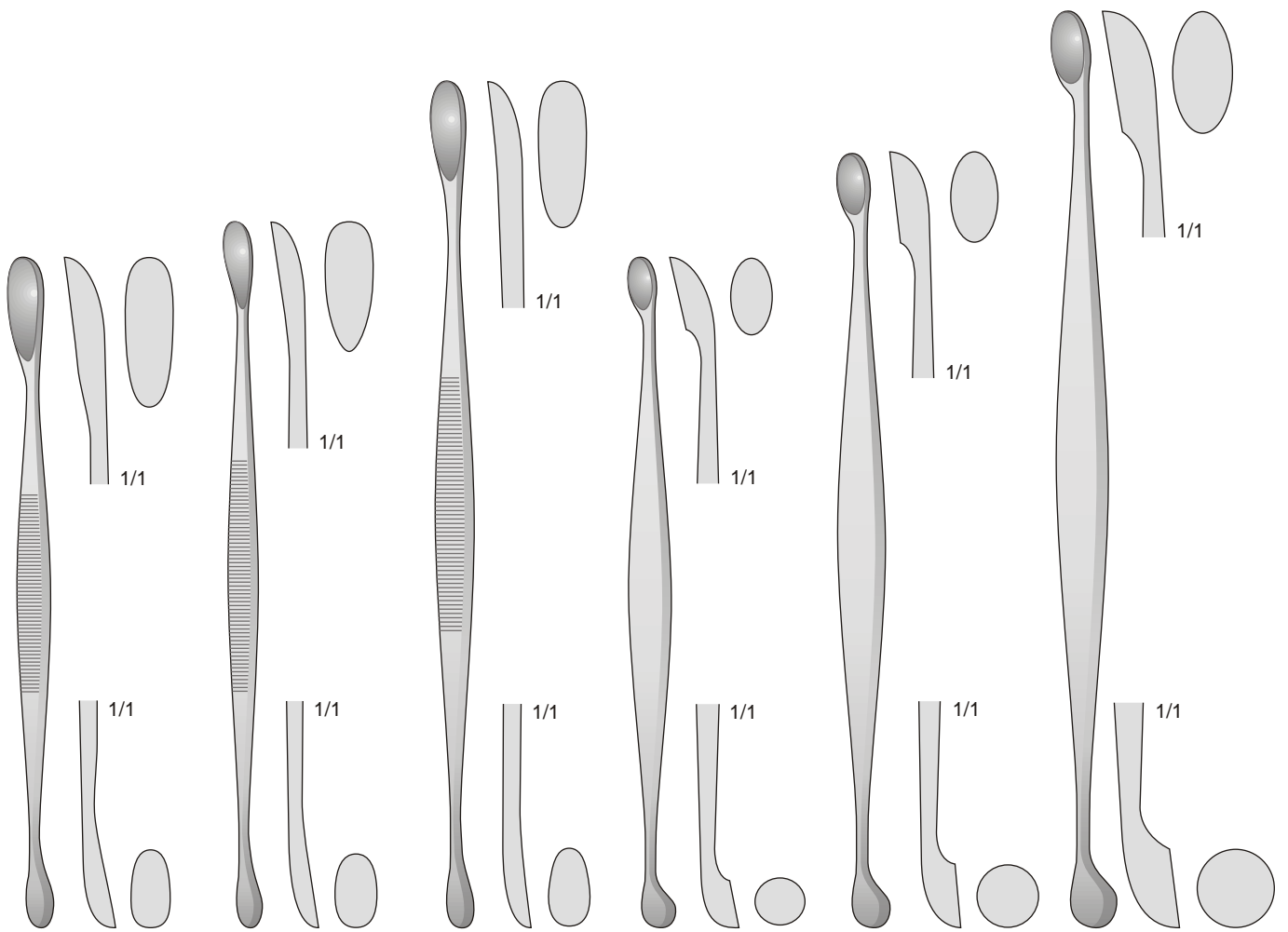

VOLKMANN
10-1430-13
130 mm

VOLKMANN
10-1430-14
145 mm

VOLKMANN
10-1430-17
170 mm

10-1440-13
130 mm

10-1440-16
160 mm

10-1440-20
200 mm

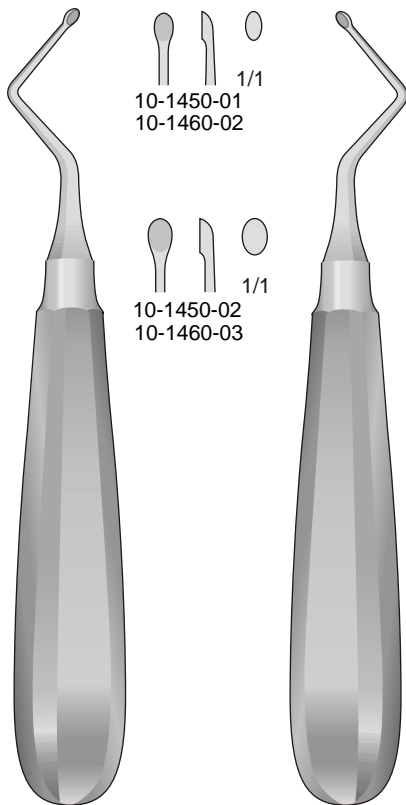

KERPEL
10-1450-01
10-1450-02
145 mm

KERPEL
10-1460-01
10-1460-02
145 mm

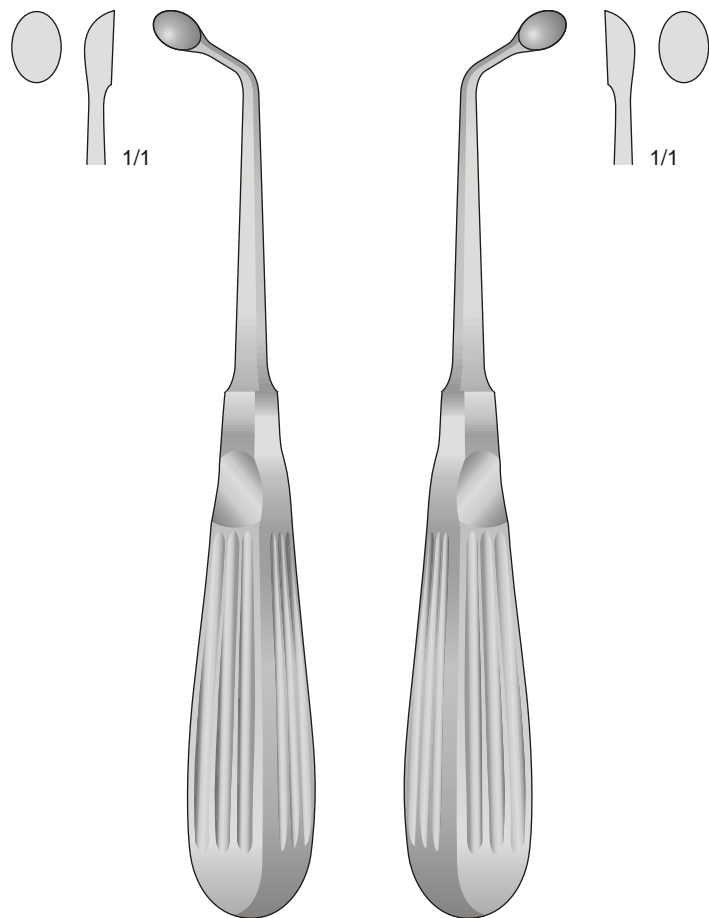

UFFENDORDE
10-1470-01
170 mm

UFFENDORDE
10-1470-02
170 mm

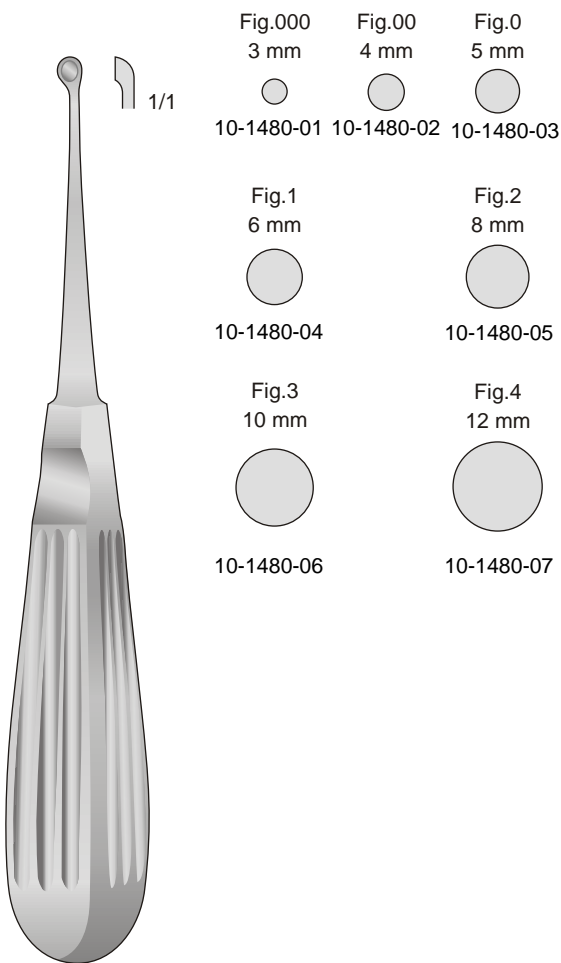

BRUNS
10-1480
165 mm

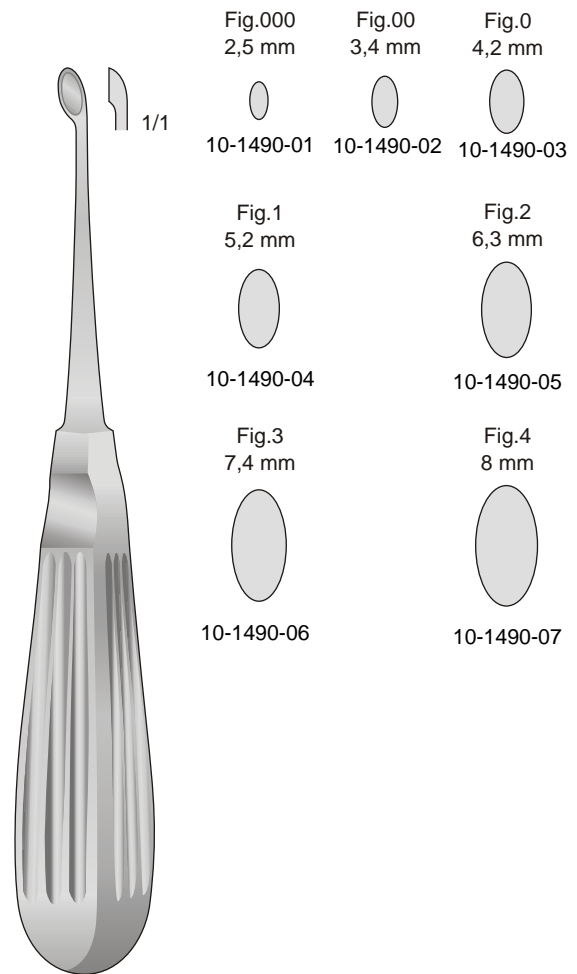

SCHEDE
10-1490
170 mm

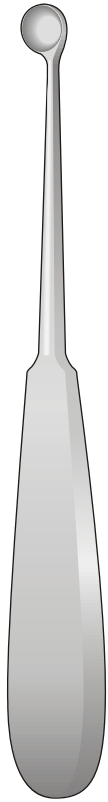

10-1500
180 mm

- | | | | |
|---------------------------------------|---------------------------------------|---------------------------------------|---------------------------------------|
| <p>Fig.1
○ 1/1
10-1500-01</p> | <p>Fig.2
○ 1/1
10-1500-02</p> | <p>Fig.3
○ 1/1
10-1500-03</p> | <p>Fig.4
○ 1/1
10-1500-04</p> |
| <p>Fig.5
○ 1/1
10-1500-05</p> | <p>Fig.6
○ 1/1
10-1500-06</p> | <p>Fig.7
○ 1/1
10-1500-07</p> | <p>Fig.8
○ 1/1
10-1500-08</p> |

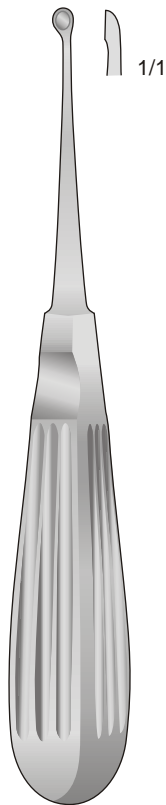

VOLKMANN
10-1510
170 mm

- | | | | | |
|---|--|---|---|---|
| <p>Fig.0000
2,8 mm
○ 1/1
10-1510-01</p> | <p>Fig.000
3,6 mm
○ 1/1
10-1510-02</p> | <p>Fig.00
4,4 mm
○ 1/1
10-1510-03</p> | <p>,Fig.0
5,2 mm
○ 1/1
10-1510-04</p> | <p>Fig.1
6,8 mm
○ 1/1
10-1510-05</p> |
| <p>Fig.2
8,5 mm
○ 1/1
10-1510-06</p> | <p>Fig.3
10 mm
○ 1/1
10-1510-07</p> | <p>Fig.4
11,5 mm
○ 1/1
10-1510-08</p> | <p>Fig.5
13 mm
○ 1/1
10-1510-09</p> | <p>Fig.6
14,5 mm
○ 1/1
10-1510-10</p> |



10-1520
210 mm

Fig.1
1/1
10-1520-01

Fig.2
1/1
10-1520-02

Fig.3
1/1
10-1520-03

Fig.4
1/1
10-1520-04

Fig.5
1/1
10-1520-05

Fig.6
1/1
10-1520-06

Fig.7
1/1
10-1520-07

Fig.8
1/1
10-1520-08

Fig.9
1/1
10-1520-09

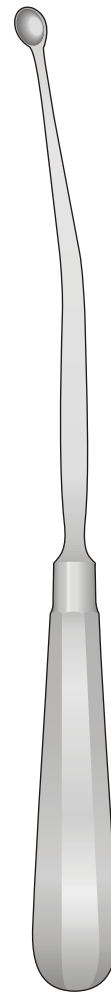

10-1530
260 mm

Fig. 1
1/1
10-1530-01

Fig. 2
1/1
10-1530-02

Fig. 3
1/1
10-1530-03

Fig. 4
1/1
10-1530-04

Fig. 5
1/1
10-1530-05

Fig. 6
1/1
10-1530-06

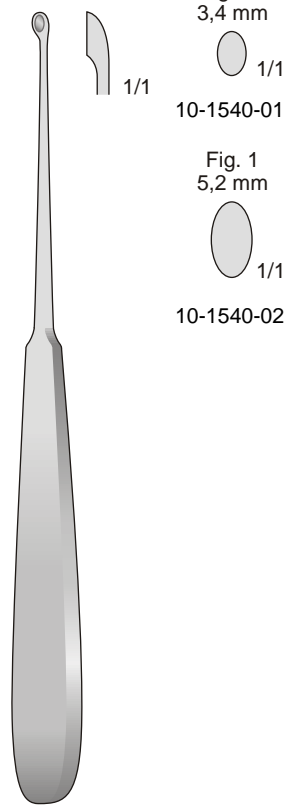

WILLIGER
10-1540
170 mm

Fig. 00
3,4 mm
1/1
10-1540-01

Fig. 1
5,2 mm
1/1
10-1540-02

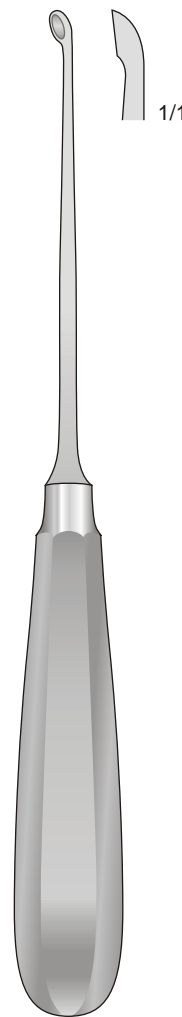

HALLE
10-1550
215 mm

Fig.00
4,4 mm
1/1
10-1550-01

Fig.0
5,2 mm
1/1
10-1550-02

Fig.1
6,8 mm
1/1
10-1550-03

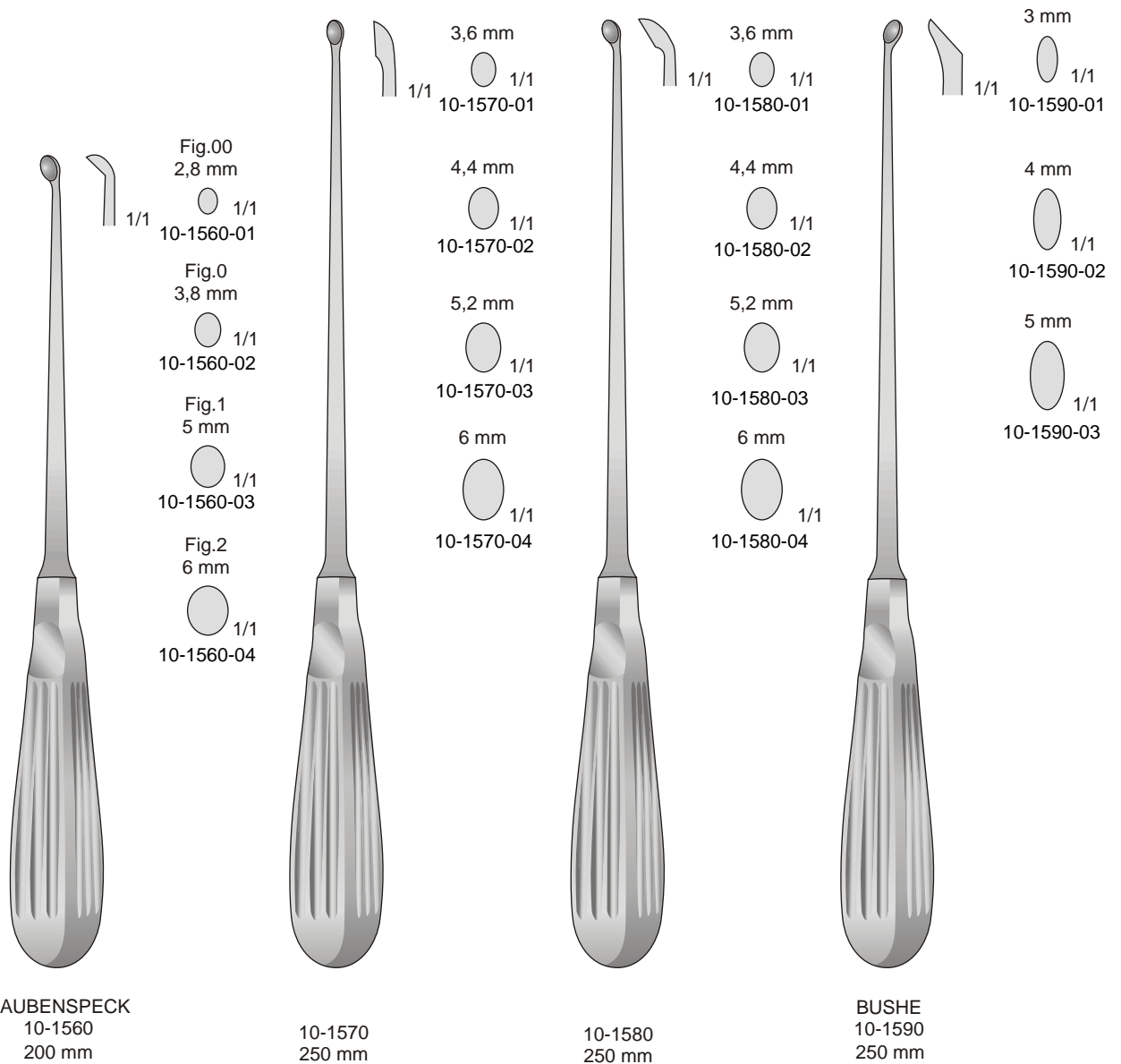

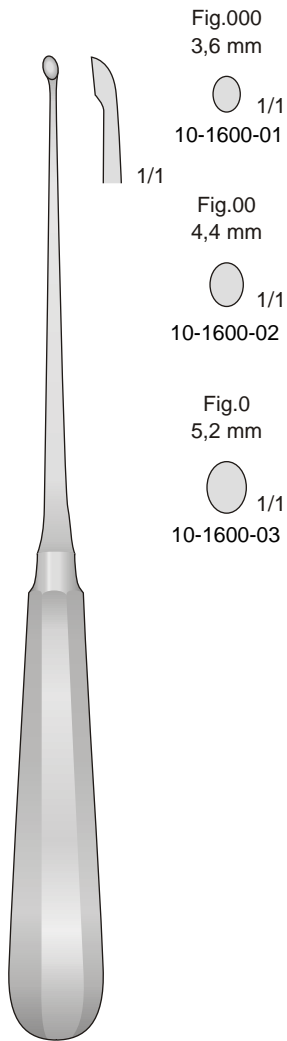

SIMON
10-1600
235 mm

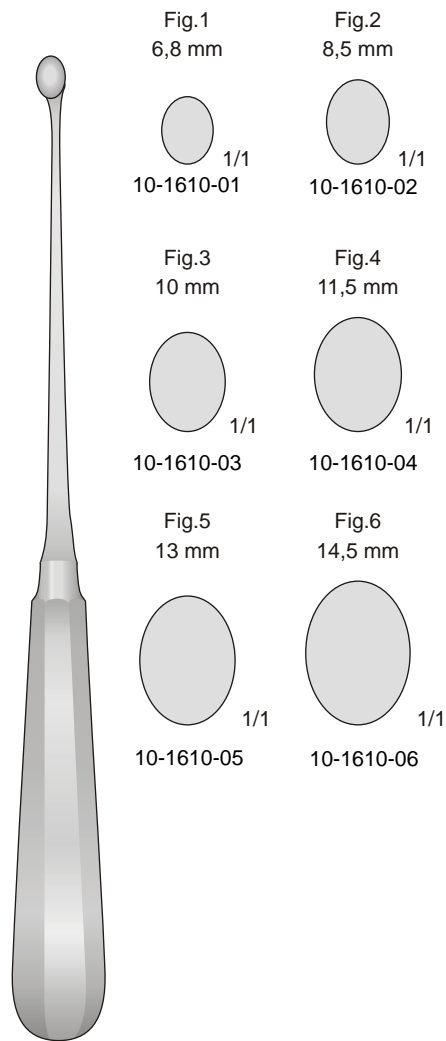

SIMON
10-1610
240 mm

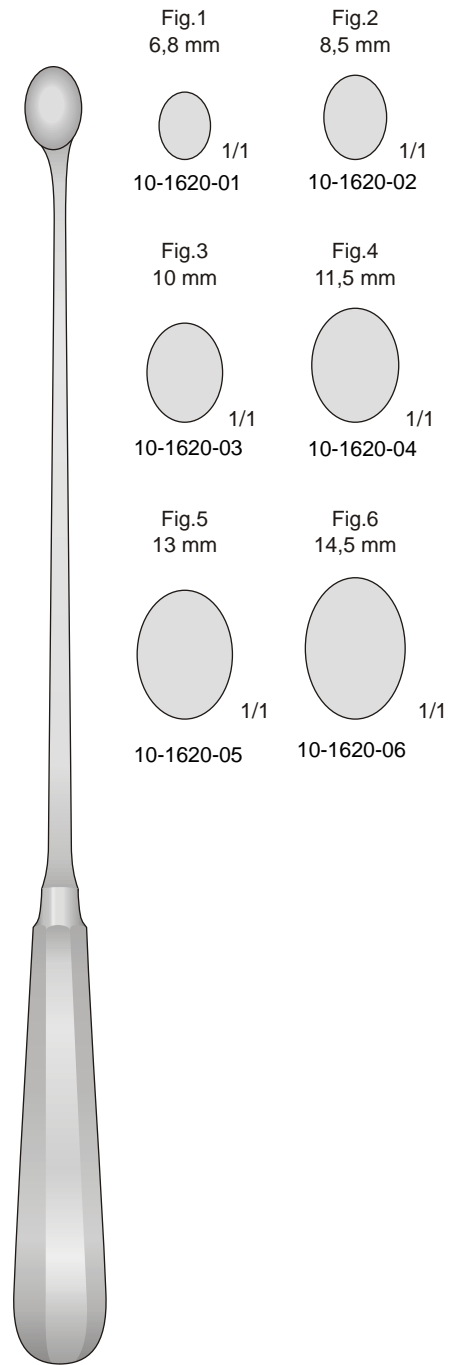

SCHRÖDER
10-1620
310 mm

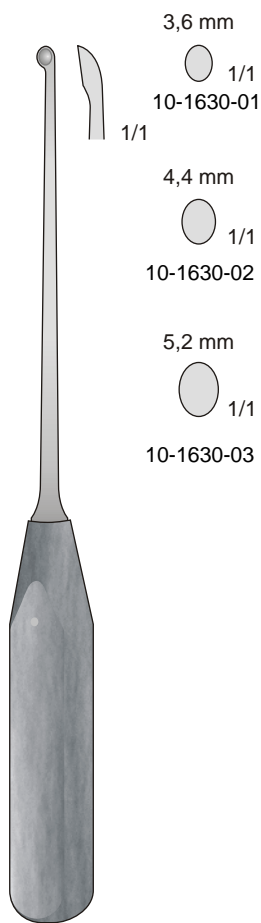

CASPAR
10-1630
220 mm

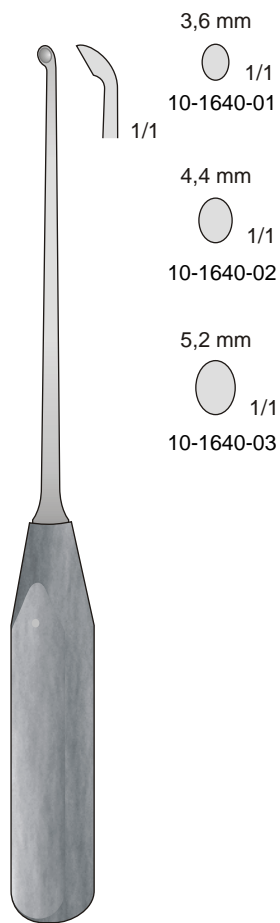

CASPAR
10-1640
220 mm

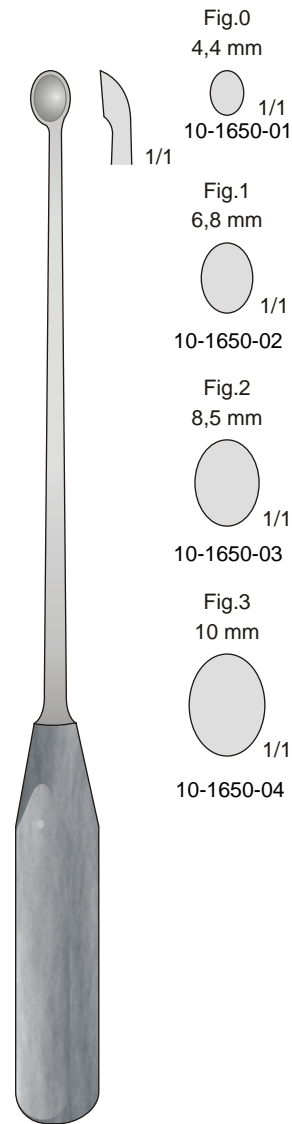

10-1650
270 mm

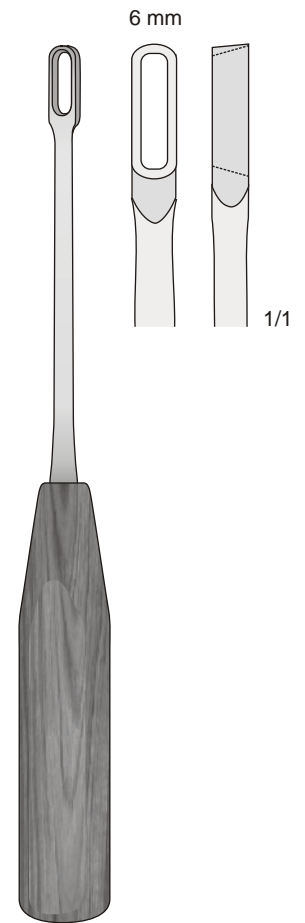

TESSIER
10-1660-22
220 mm

Strumentario per protesi femorale
Femoral prosthesis instrumentation
Instruments pour prothese femorale

Con manico Ferrozell
With Ferrozell handle
Mit Ferrozellgriff
Avec poignée en Ferrozell
Con mango de Ferrozell

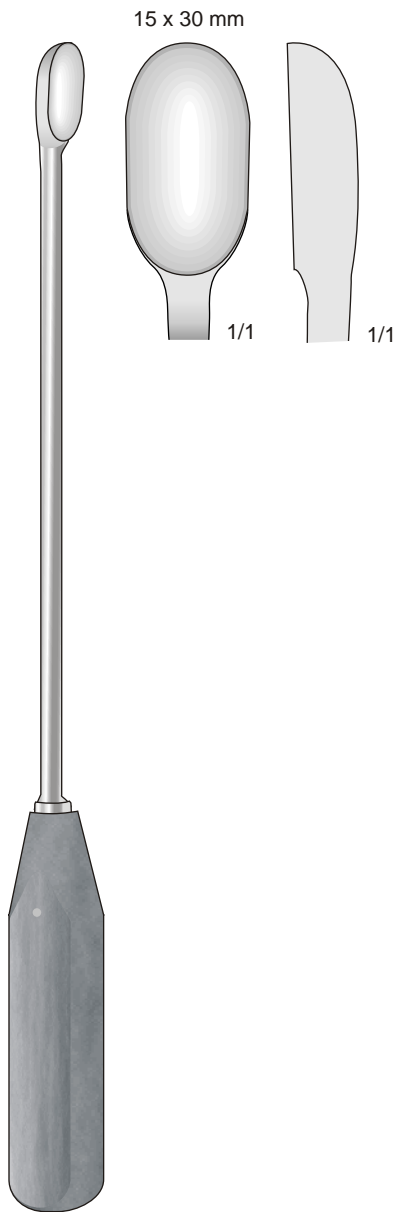

10-1670-300
300 mm

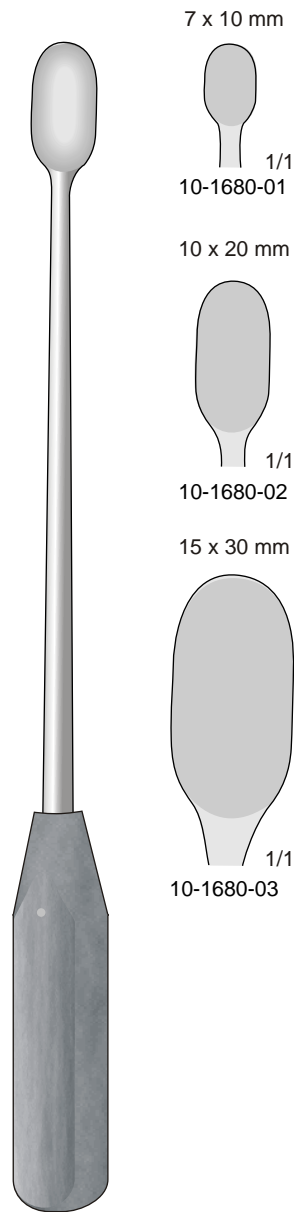

10-1680
300 mm

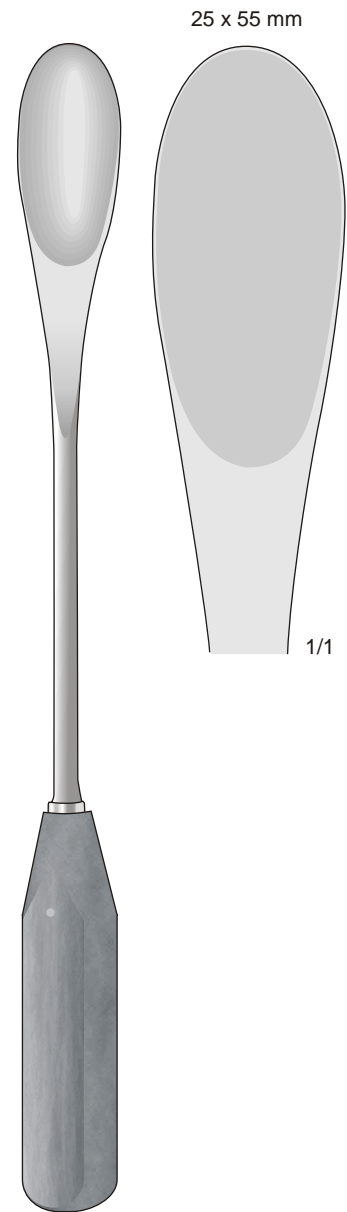

10-1690-300
300 mm