

## SUCTION TUBES

Saugkanülen

Canules d'aspiration

Cánulas de aspiración

Cannule per aspirazione



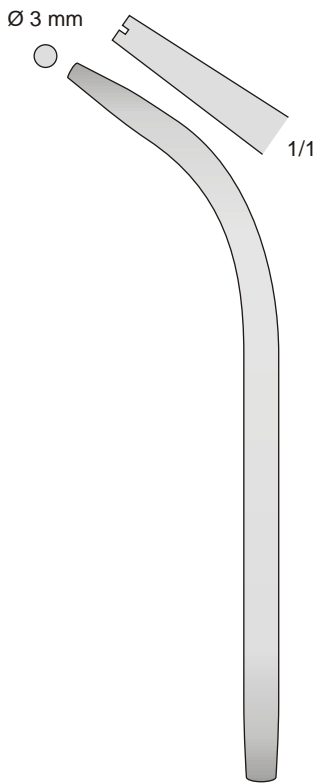

16-100-01  
140 mm

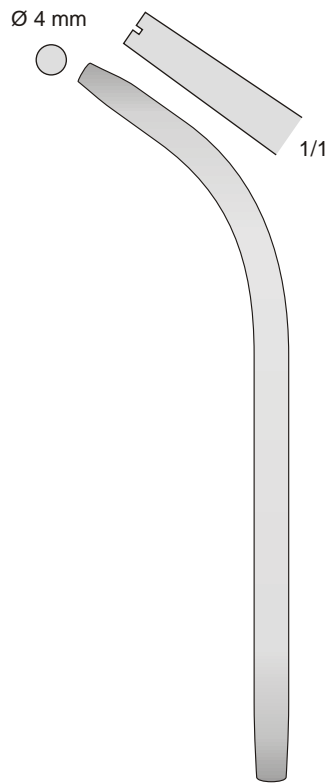

16-100-02  
140 mm

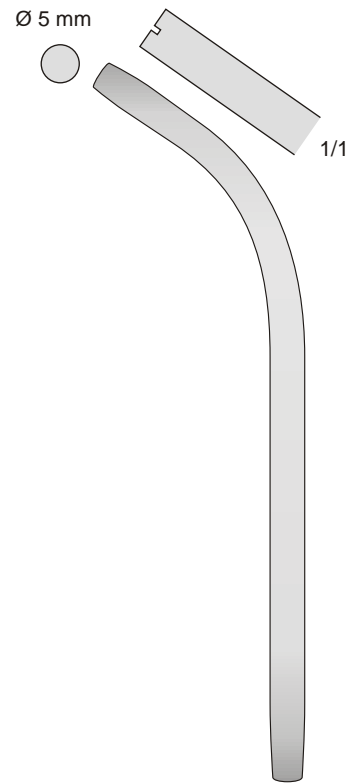

16-100-03  
140 mm

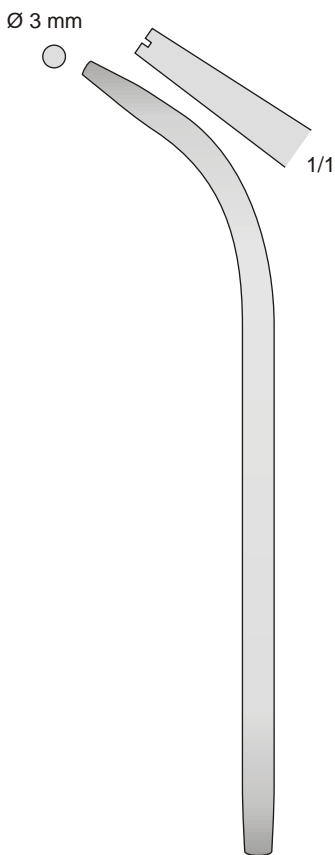

16-110-01  
170 mm

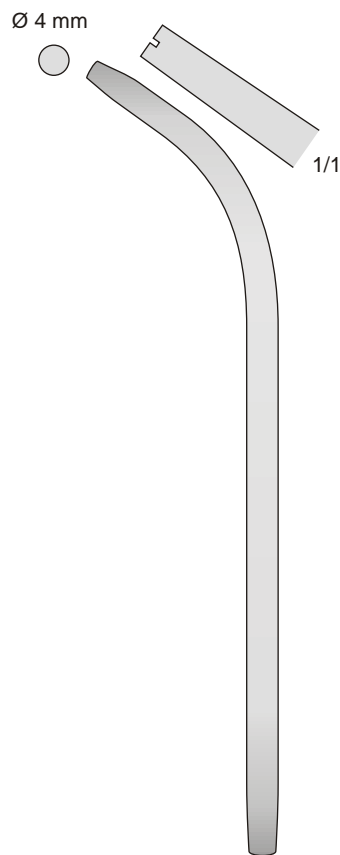

16-110-02  
170 mm

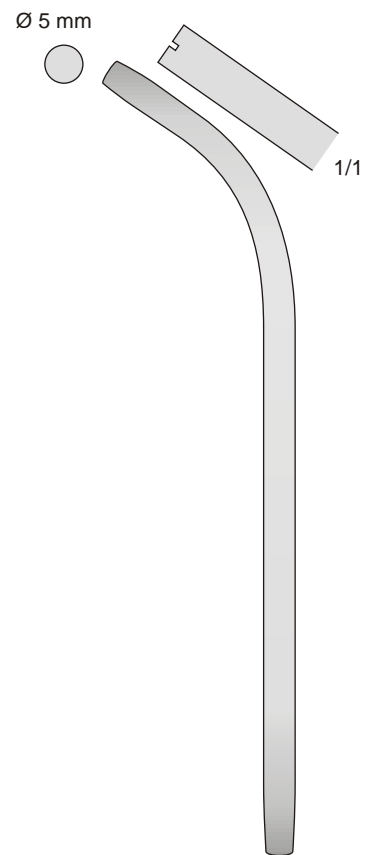

16-110-03  
170 mm

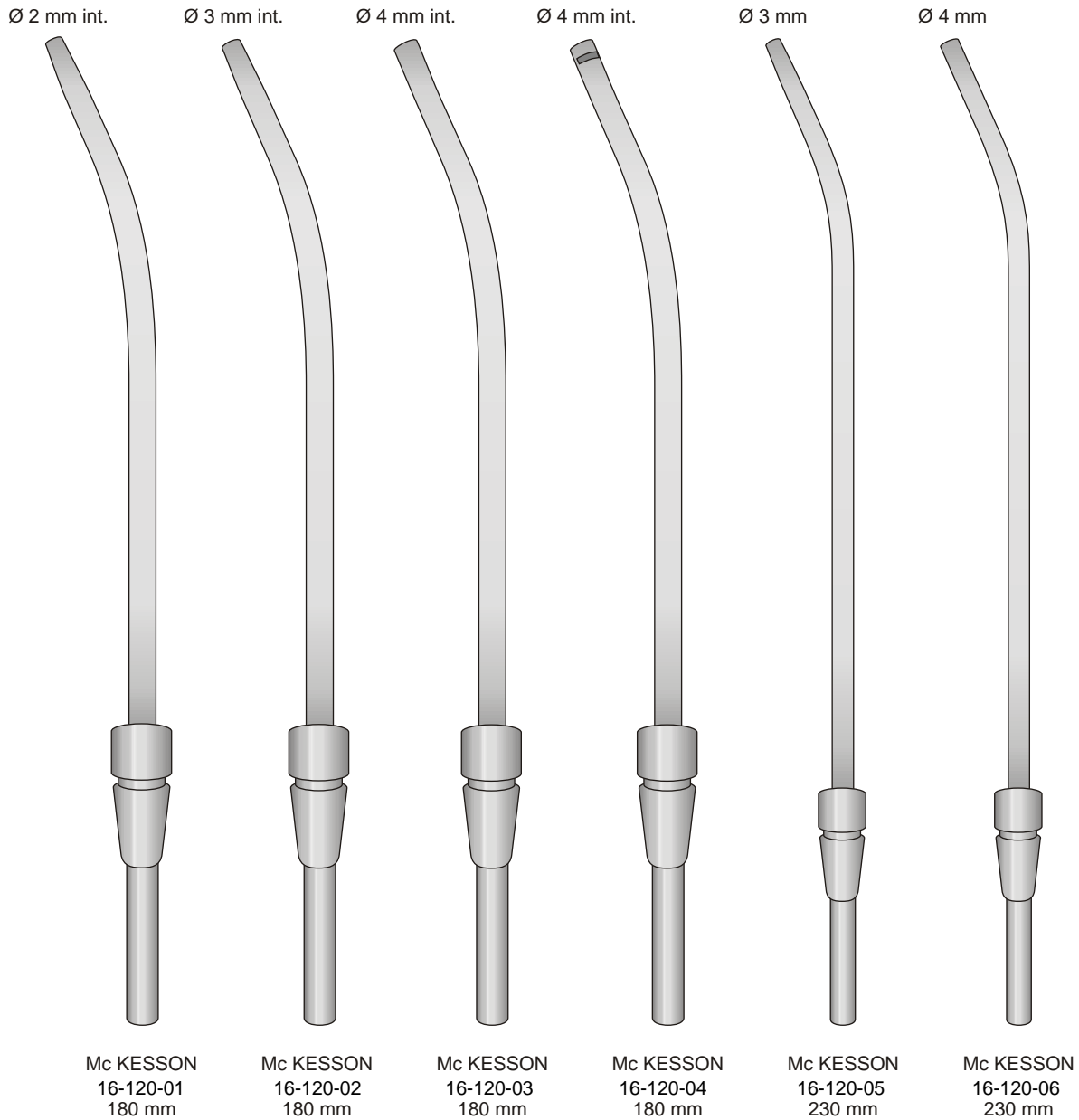

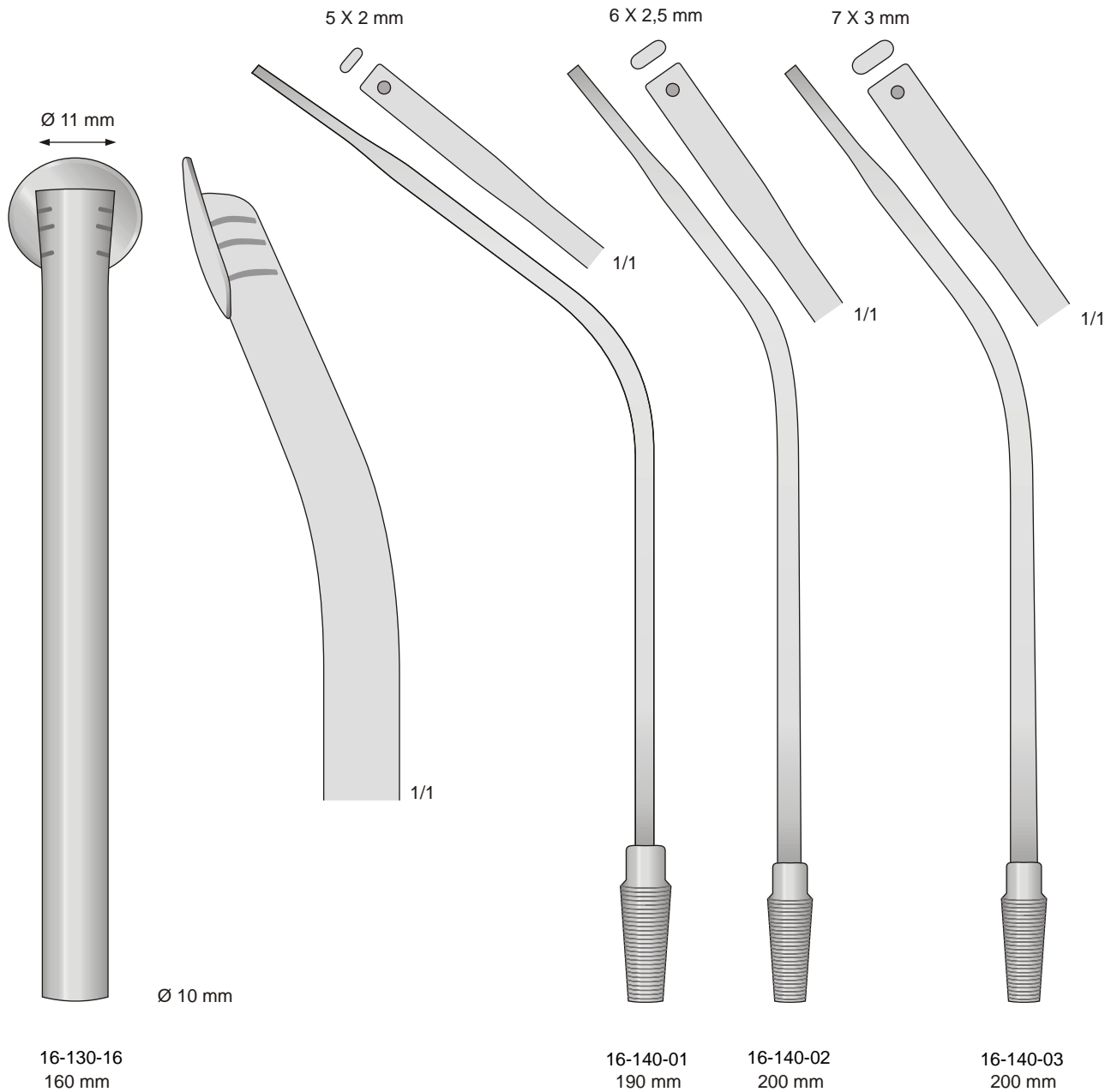

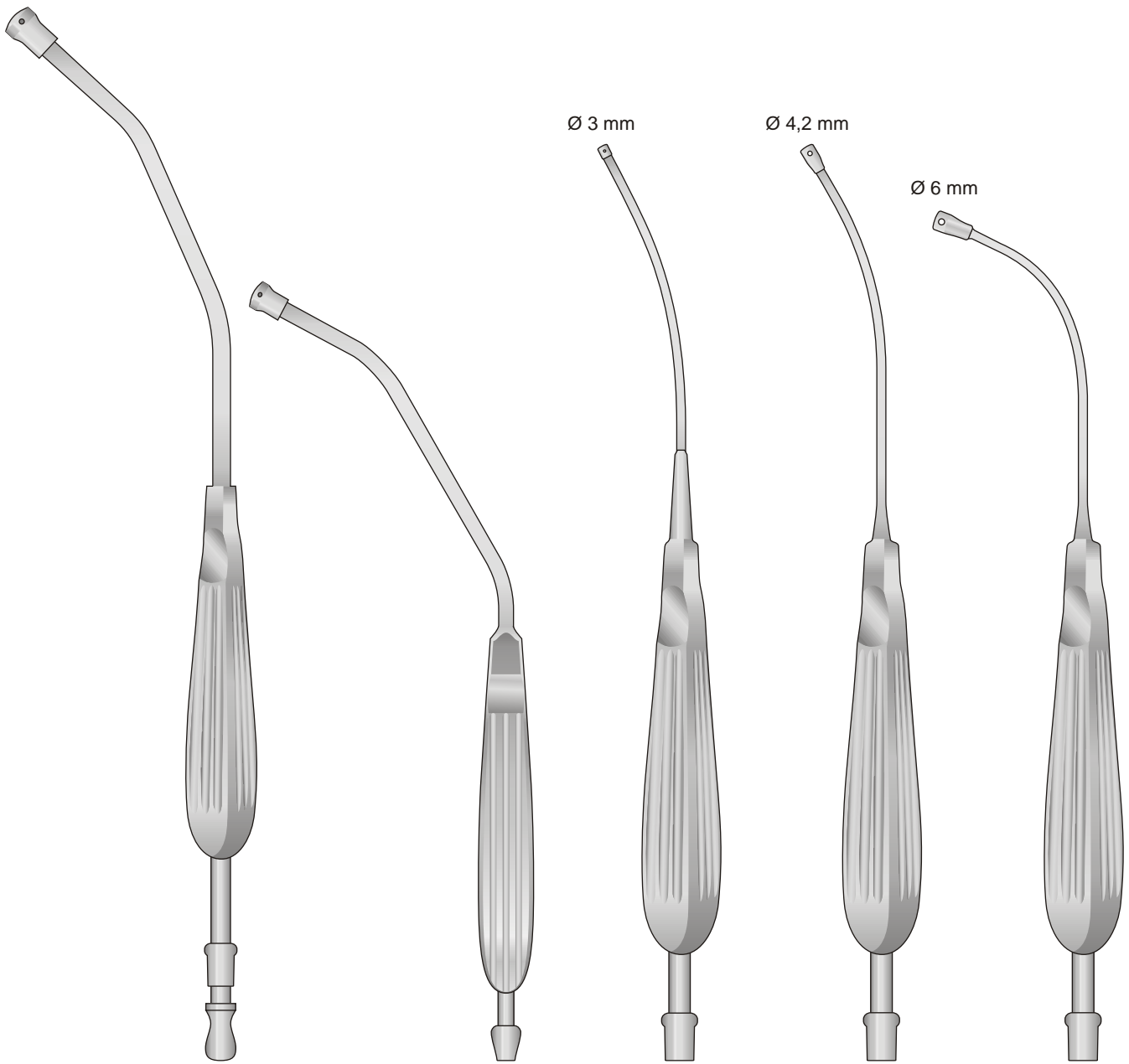

YANKAUER  
16-150-31  
310 mm

BABY-YANKAUER  
16-160-21  
200 mm

ANDREWS-PYNCHON  
16-170-01  
250 mm

ANDREWS-PYNCHON  
16-170-02  
250 mm

ANDREWS-PYNCHON  
16-170-03  
230 mm

Manico portacanule  
Set - Satz - Jeu - Jeugo

Completo con 4 canule  
Complet with 4 tubes  
Komplett mit 4 Kanülen  
Complete avec 4 canules  
Completo con 4 cànulas

Manico portacanule  
Set - Satz - Jeu - Jeugo

Completo con 3 canule  
Complet with 3 tubes  
Komplett mit 3 Kanülen  
Complete avec 3 canules  
Completo con 3 cànulas

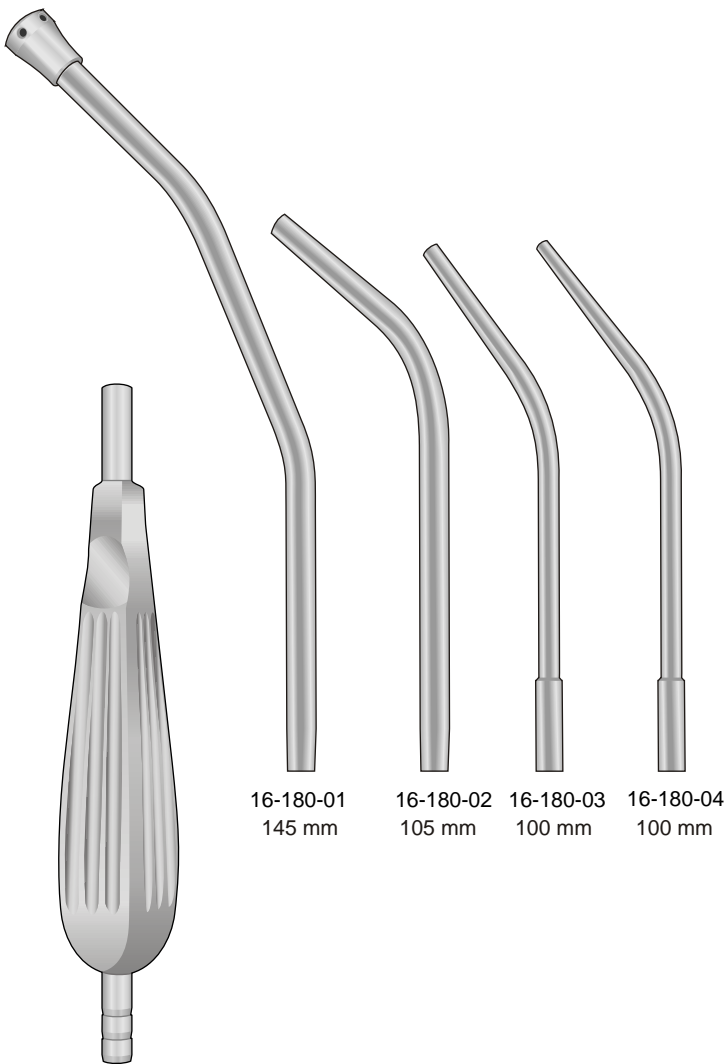

16-180  
150 mm

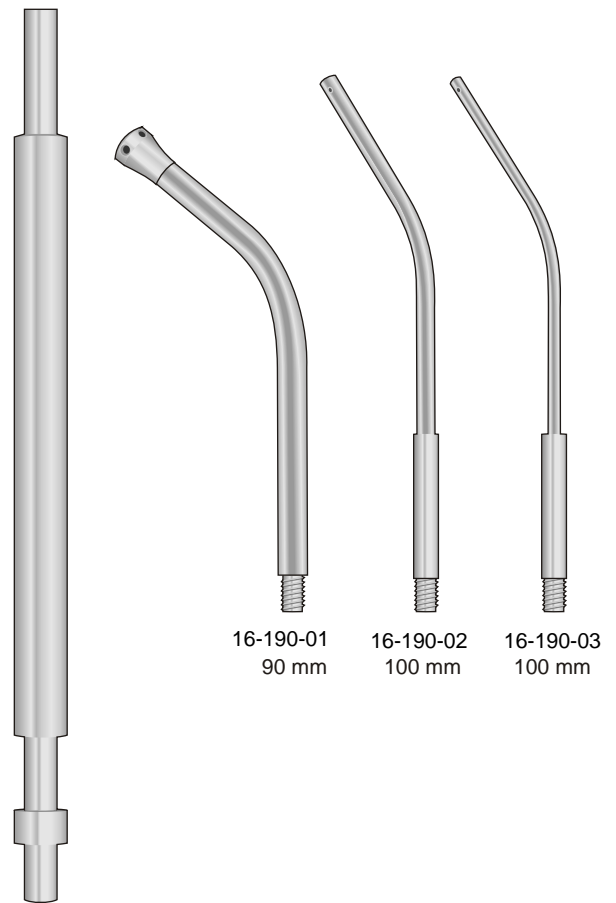

16-190  
170 mm

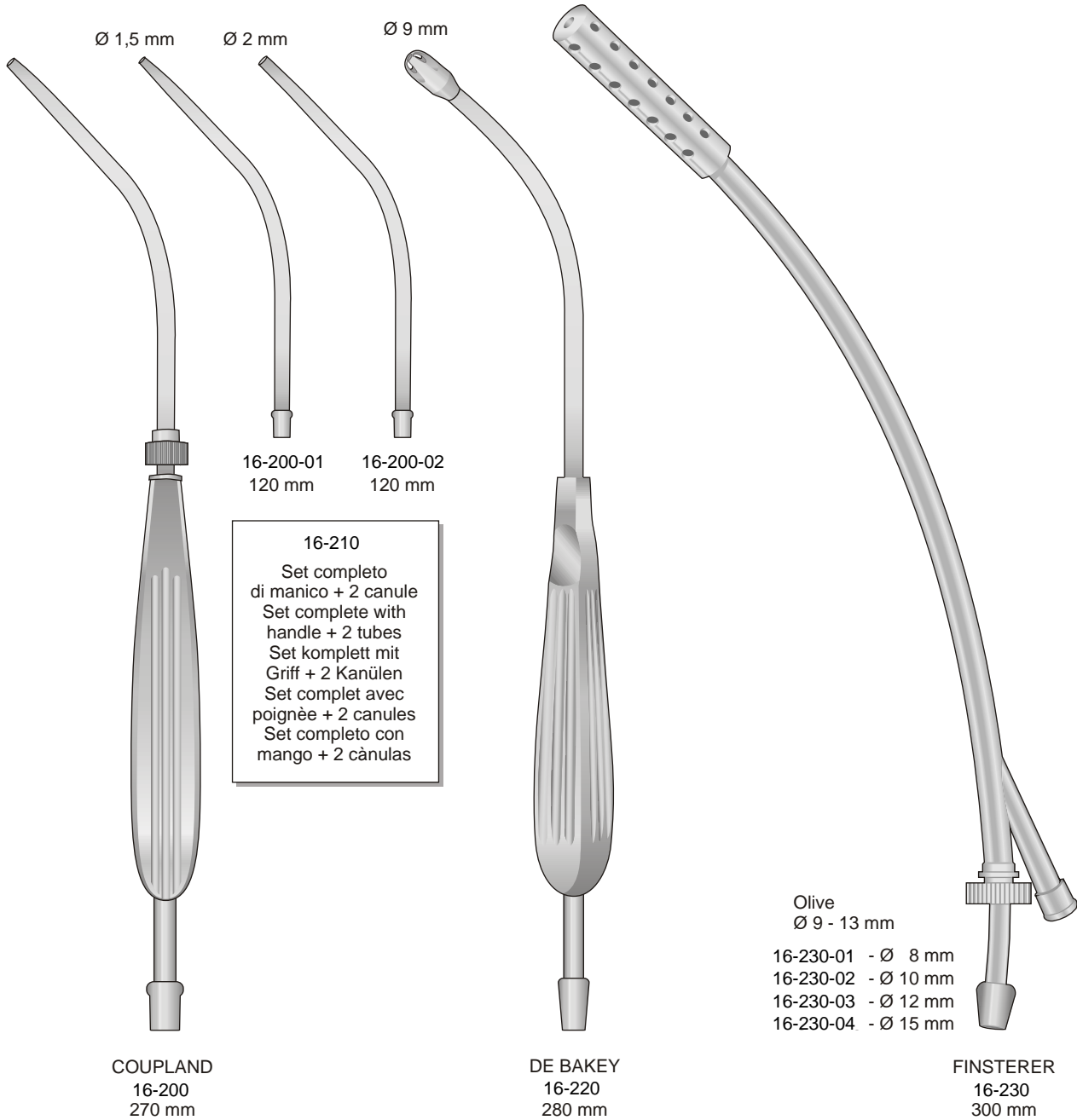

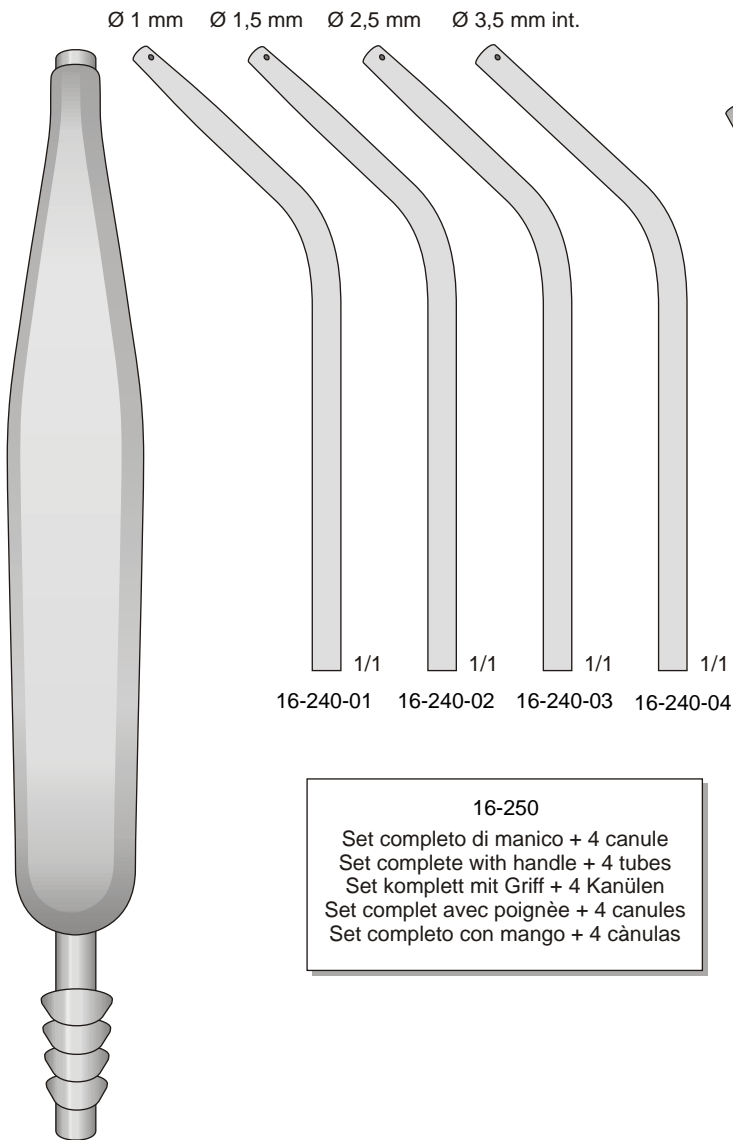

**COUPLAND**  
16-240  
150 mm

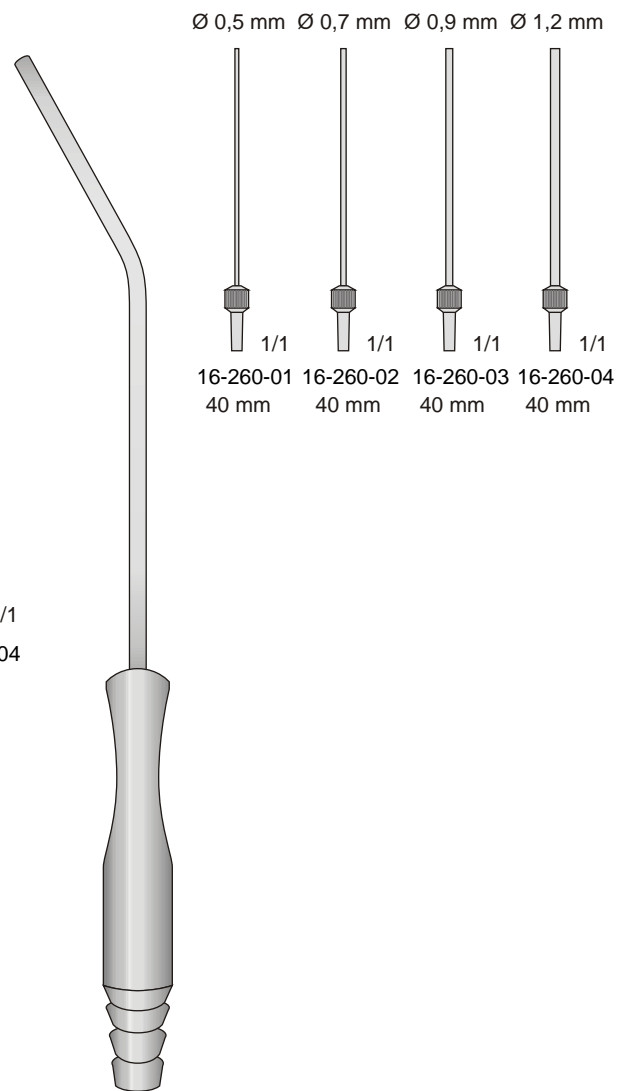

**WULLSTEIN**  
16-260  
140 mm



Acciaio chirurgico - Stainless steel - Rostfrei - Acier - Acero



16-270-18  
180 mm

Ø 6 mm

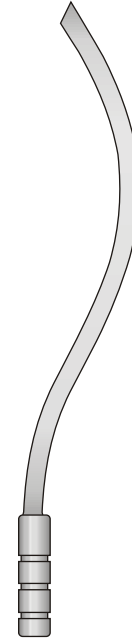

16-270-17  
175 mm

Ø 9 mm

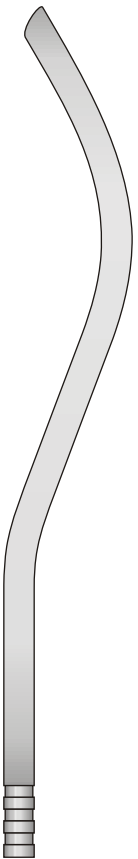

16-270-23  
230 mm

Ø 6 mm

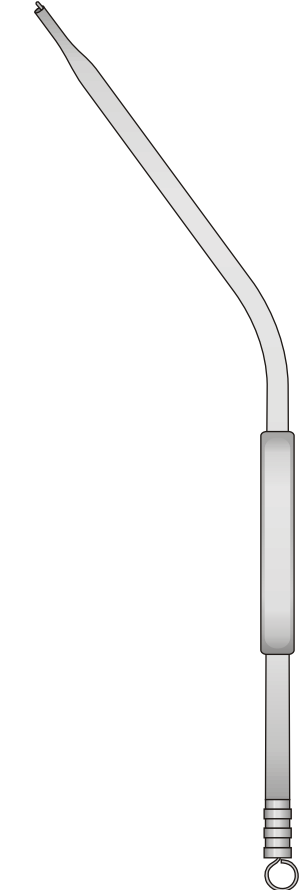

16-280-24  
240 mm

Ø 4 mm

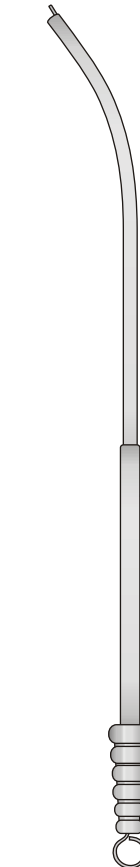

16-280-23  
230 mm

6 mm



Rotondo  
Round  
Rund  
Ronde  
Redonda



NUBOER  
16-290-01  
210 mm

6 mm



Ovale  
Oval  
Ovale  
Ovale  
Ovalada

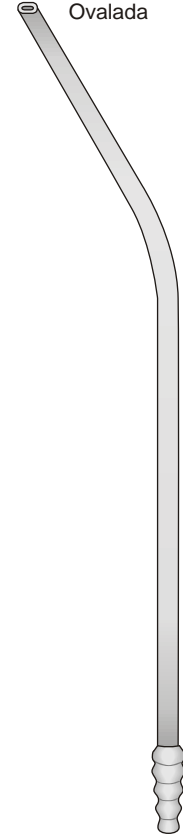

NUBOER  
16-290-02  
210 mm

Raschiatti

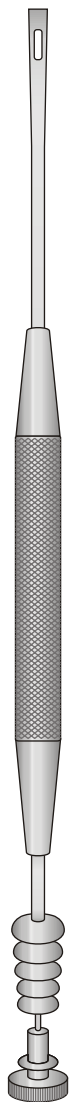

GORNEY  
16-300-18  
180 mm

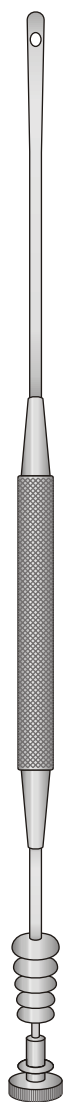

GORNEY  
16-300-20  
200 mm

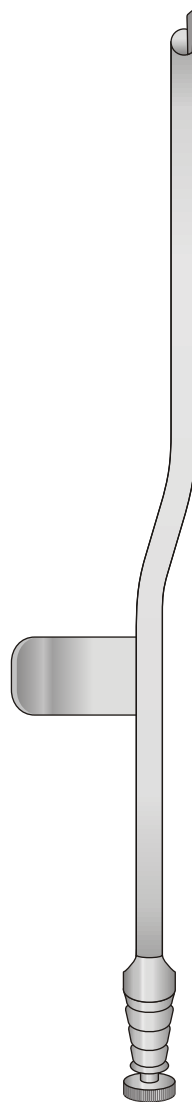

SAUG-RASPATORIUM  
16-310-01 Ø 4 mm  
16-310-02 Ø 5 mm  
200 mm  
16-310

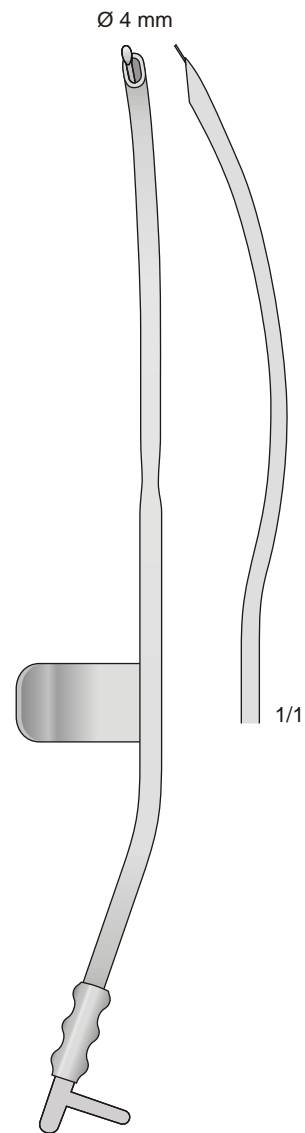

GUILLIEN  
16-320  
200 mm

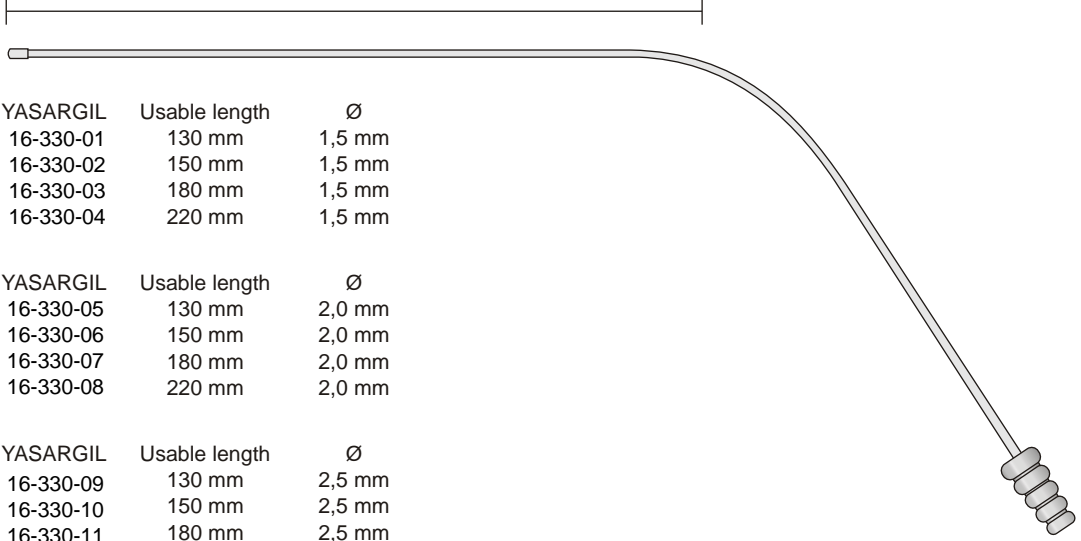

YASARGIL	Usable length	Ø
16-330-01	130 mm	1,5 mm
16-330-02	150 mm	1,5 mm
16-330-03	180 mm	1,5 mm
16-330-04	220 mm	1,5 mm
YASARGIL	Usable length	Ø
16-330-05	130 mm	2,0 mm
16-330-06	150 mm	2,0 mm
16-330-07	180 mm	2,0 mm
16-330-08	220 mm	2,0 mm
YASARGIL	Usable length	Ø
16-330-09	130 mm	2,5 mm
16-330-10	150 mm	2,5 mm
16-330-11	180 mm	2,5 mm
16-330-12	220 mm	2,5 mm
YASARGIL	Usable length	Ø
16-330-13	130 mm	3,5 mm
16-330-14	150 mm	3,5 mm
16-330-15	180 mm	3,5 mm
16-330-16	220 mm	3,5 mm
YASARGIL	Usable length	Ø
16-330-17	180 mm	4,5 mm

YASARGIL  
16-330

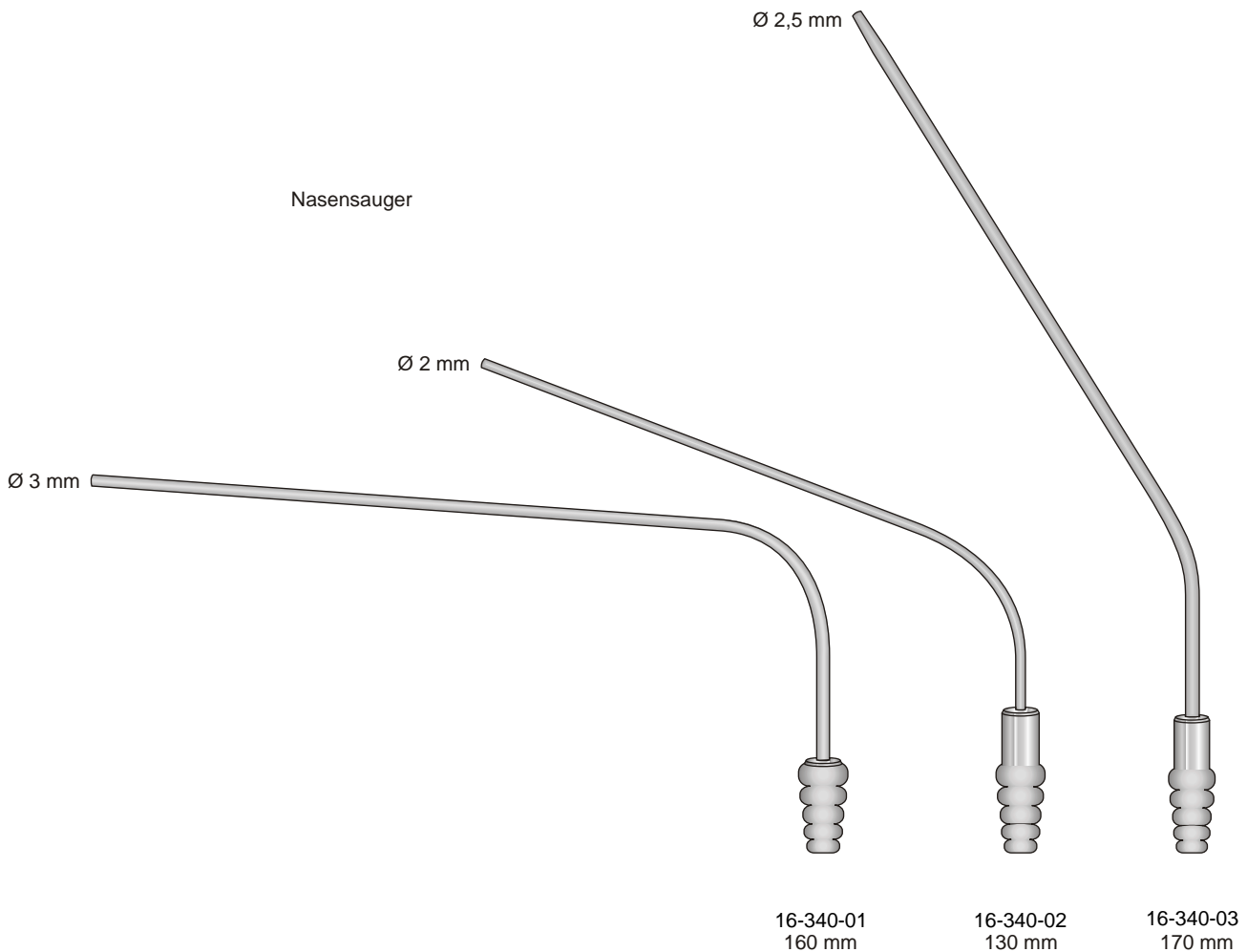

Char. 6	= 2 mm
Char 7	= 2,5 mm
Char 9	= 3 mm
Char 10	= 3,3 mm
Char 12	= 4 mm
Char 15	= 5 mm

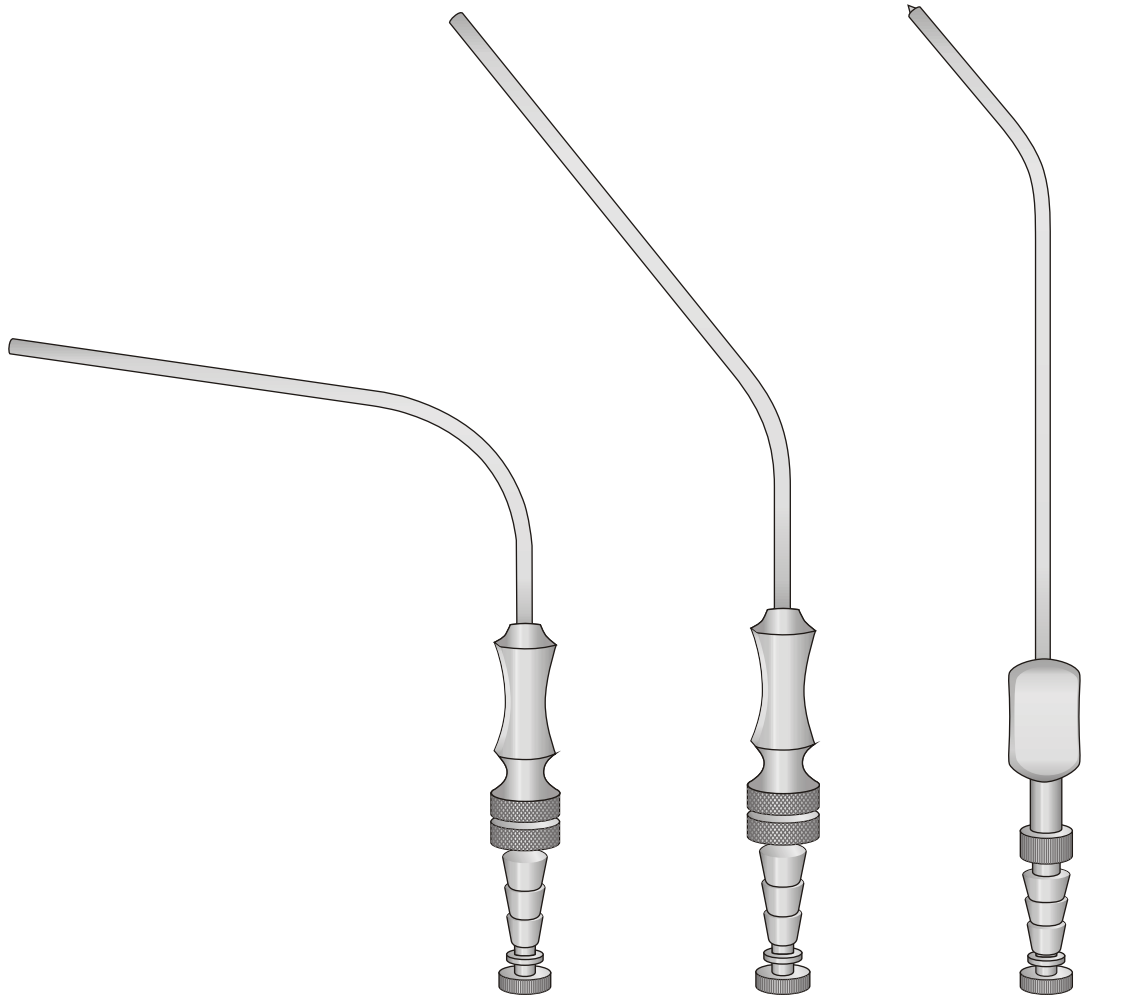

**FERGUSSON**  
16-350-01 Ch. 6  
16-350-02 Ch. 7  
16-350-03 Ch. 9  
16-350-04 Ch. 12  
16-350-05 Ch. 15  
180 mm

**FRAZIER**  
16-360-01 Ch. 6  
16-360-02 Ch. 7  
16-360-03 Ch. 9  
16-360-04 Ch. 12  
16-360-05 Ch. 15  
180 mm

**PLESTER**  
16-370-01 Ch. 6  
16-370-02 Ch. 7  
16-370-03 Ch. 9  
16-370-04 Ch. 12  
16-370-05 Ch. 15  
200 mm

Char. 3	= 1 mm
Char 5	= 1,7 mm
Char 7	= 2,5 mm
Char 10	= 3,3 mm
Char 12	= 4 mm

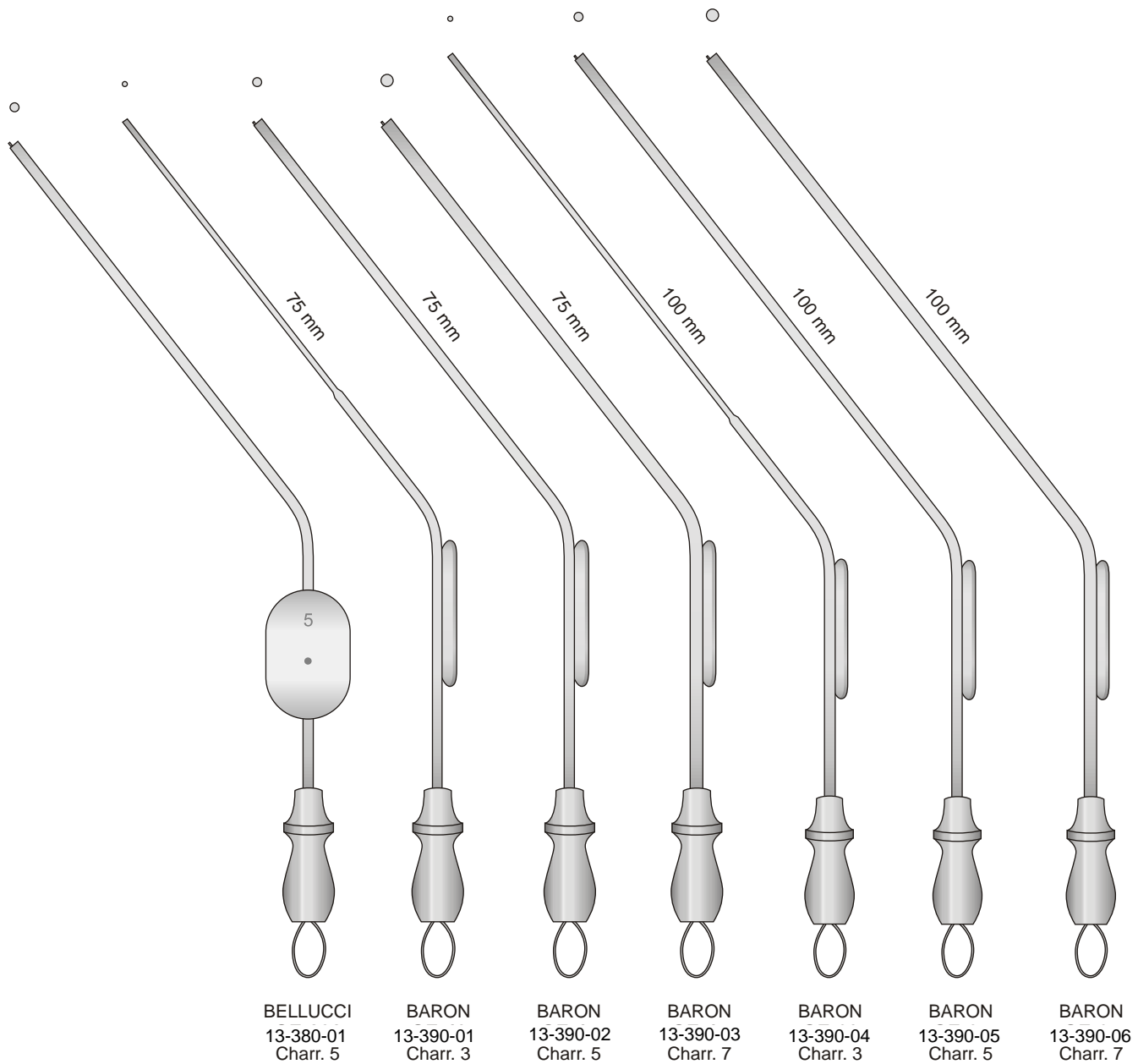

Char. 3	= 1 mm
Char 5	= 1,7 mm
Char 7	= 2,5 mm
Char 10	= 3,3 mm
Char 12	= 4 mm

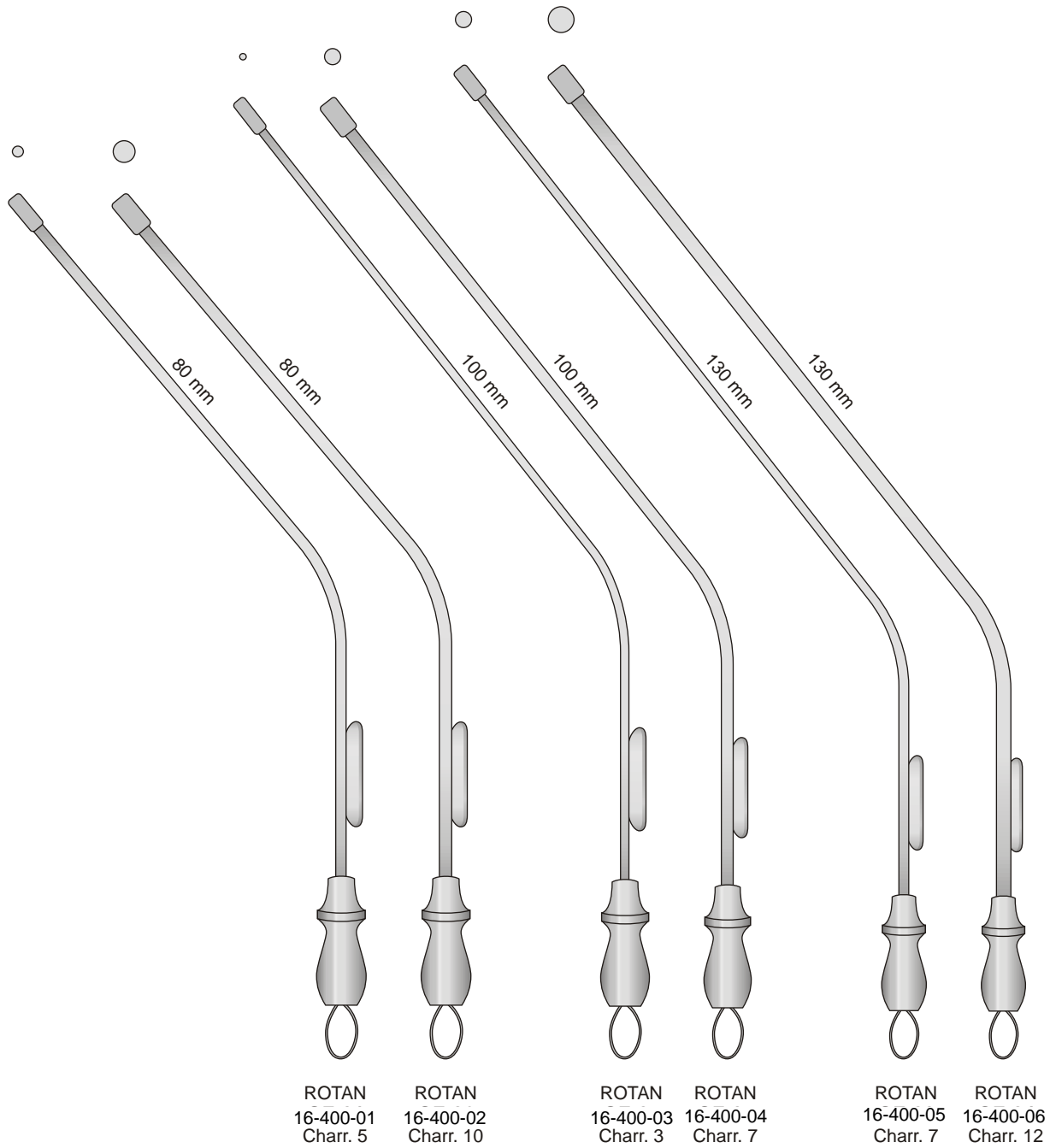

Char. 3	= 1 mm
Char 5	= 1,7 mm
Char 7	= 2,5 mm
Char 10	= 3,3 mm
Char 12	= 4 mm
Char 14	= 4,6 mm

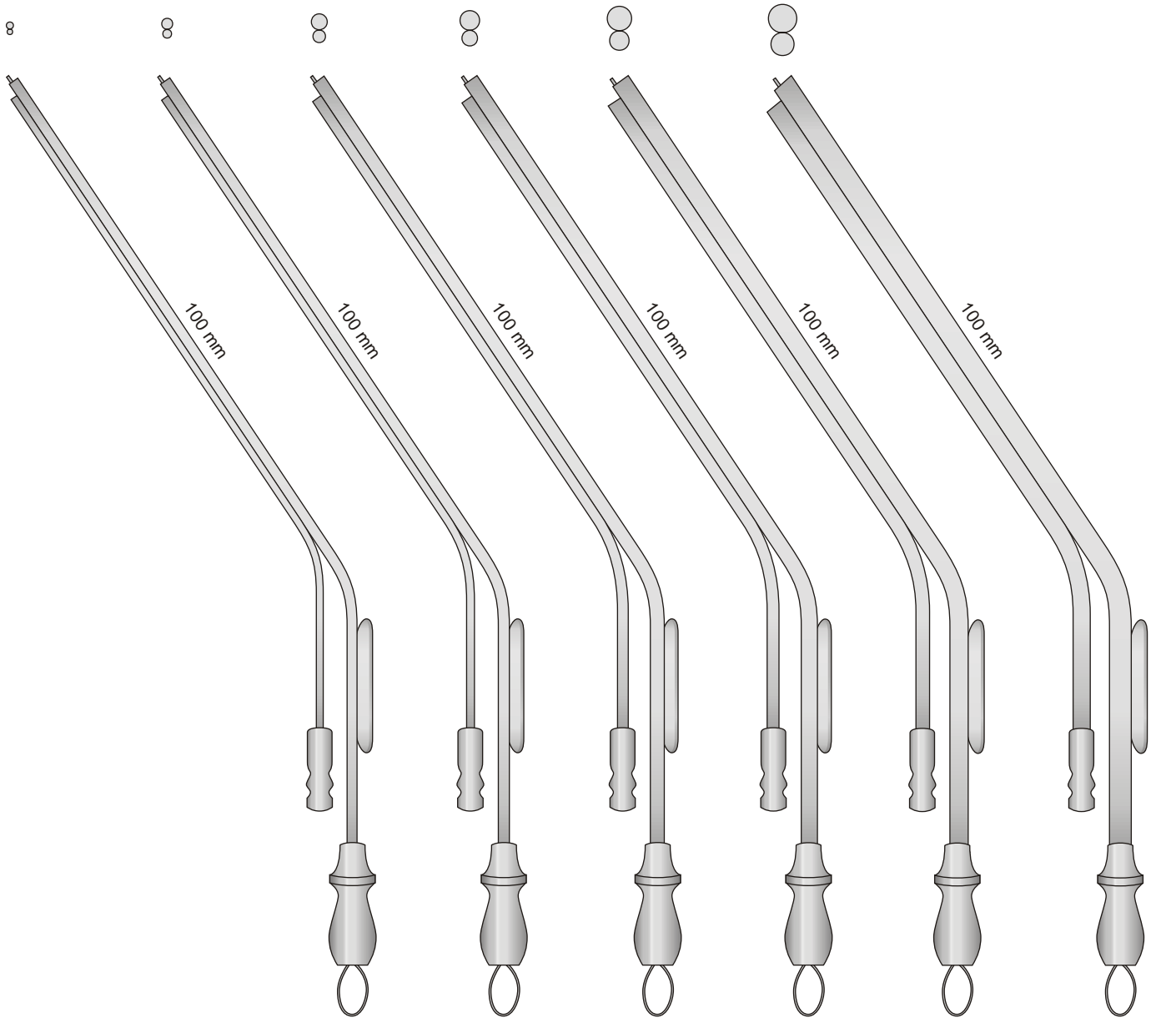

HOUSE  
16-410-01  
Charr. 3

HOUSE  
16-410-02  
Charr. 5

HOUSE  
16-410-03  
Charr. 7

HOUSE  
16-410-04  
Charr. 10

HOUSE  
16-410-05  
Charr. 12

HOUSE  
16-410-06  
Charr. 14

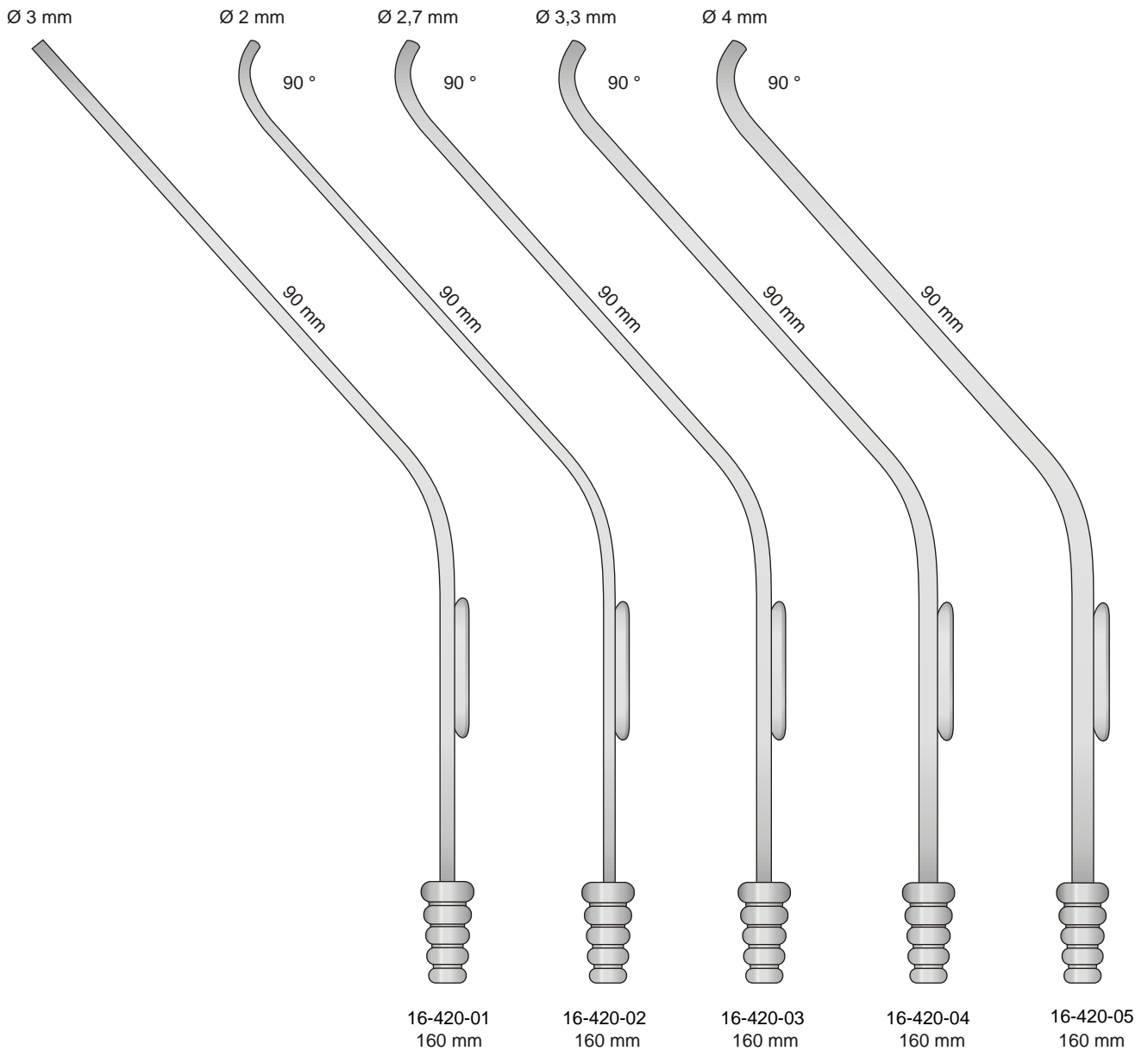



Malleabile  
Malleable  
Bięgsam  
Mallęables  
Malleable  
Ø 3 mm

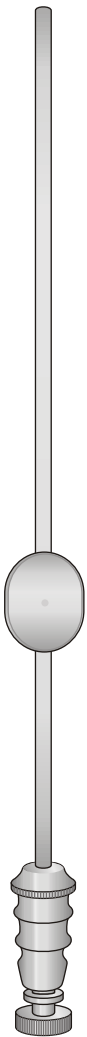

WERTHEIMER  
16-450-16  
160 mm

**Cromata nera**

Malleabile  
Malleable  
Bięgsam  
Mallęables  
Malleable  
Ø 3 mm

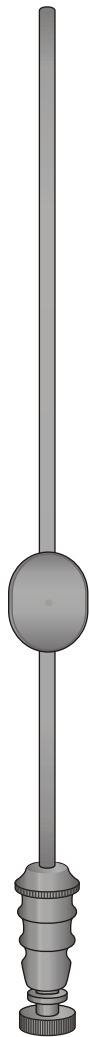

FRAZIER  
16-460-16  
160 mm

Malleabile  
Malleable  
Bięgsam  
Mallęables  
Malleable  
Ø 3 mm

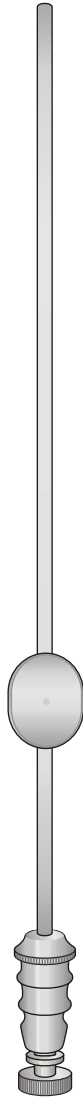

WERTHEIMER  
16-450-20  
200 mm

**Cromata nera**

Malleabile  
Malleable  
Bięgsam  
Mallęables  
Malleable  
Ø 3 mm

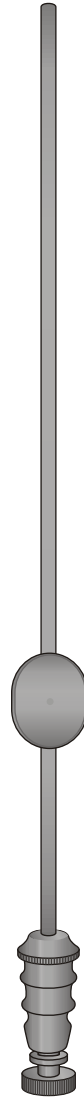

FRAZIER  
16-460-20  
200 mm

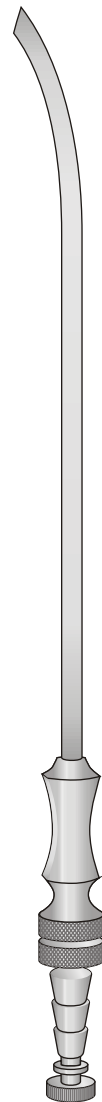

ADSON  
16-470-01 ch. 12  
16-470-02 ch. 15  
210 mm  
16-470

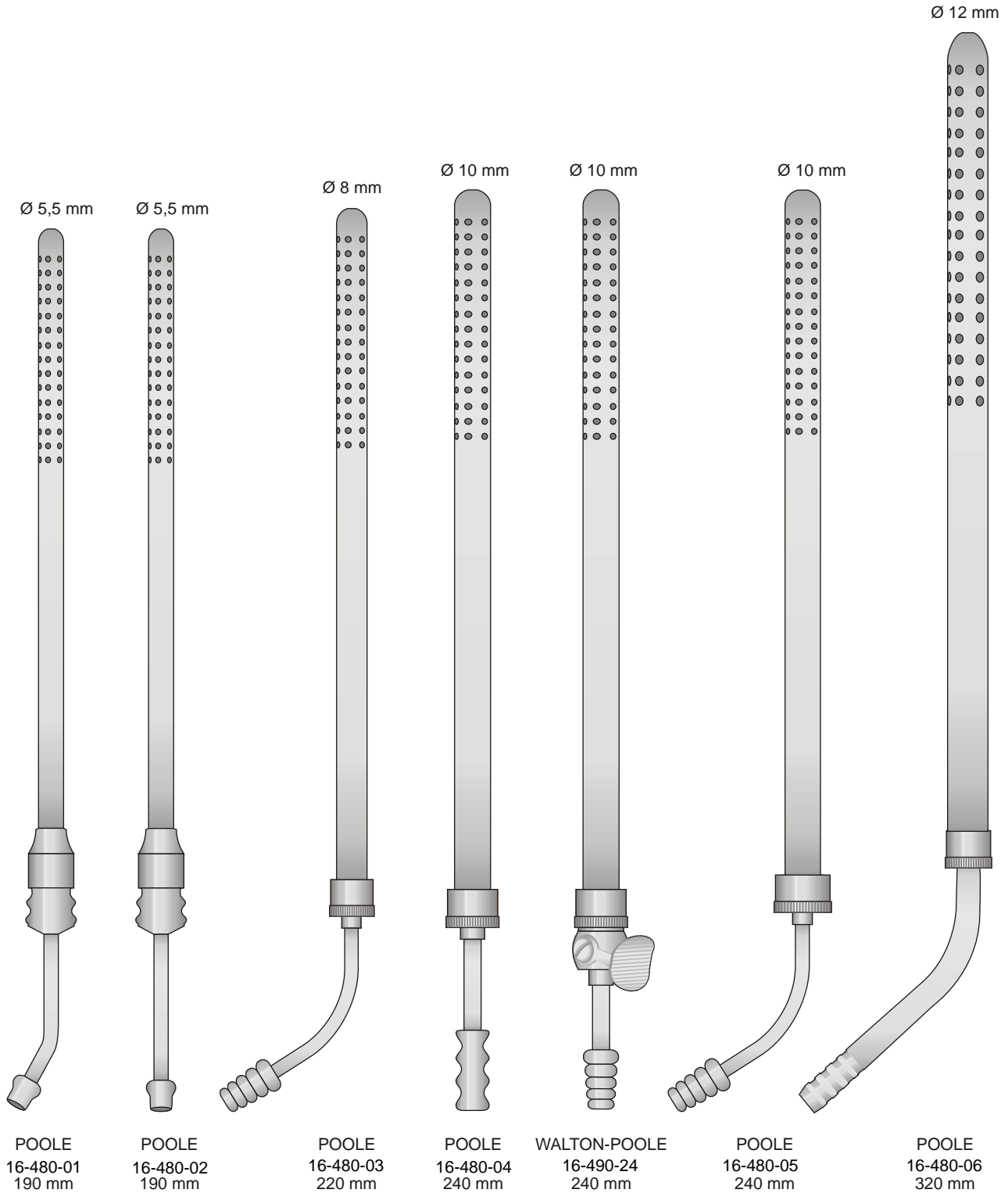

16-550  
Set completo con:  
Set complete with:  
Komplettsset mit:  
Set complet avec:  
Set completos con:

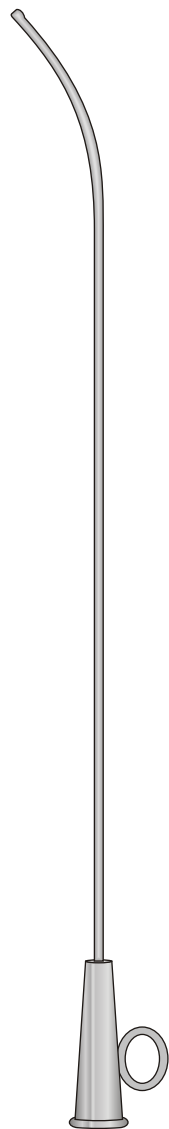

16-500-01- Ø 1,5 mm  
16-500-02- Ø 2 mm  
16-500-03- Ø 2,5 mm

HARTMANN  
16-500  
170 mm

Ø 4 mm

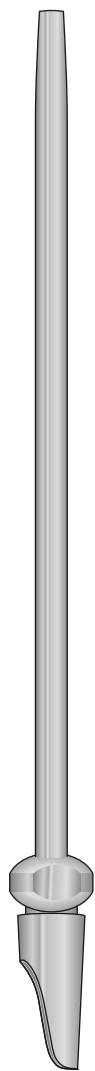

Ø 4 mm

16-510-16  
160 mm

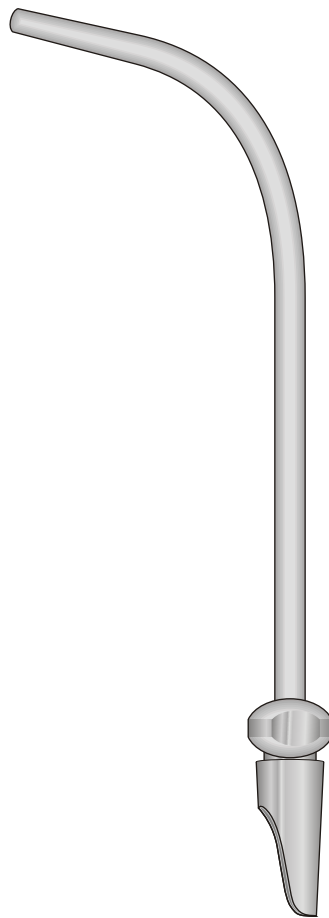

16-510-14  
145 mm

Pompetta in plastica

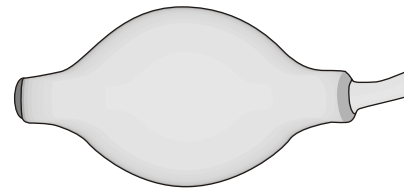

16-540

Raccordo in silicone per canule  
Autoclavabile

2 mt.

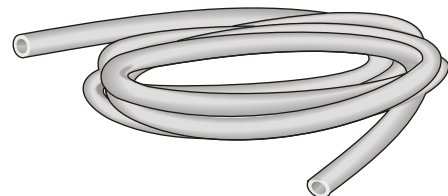

16-530  
2 mt.

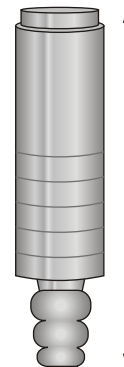

65 mm

16-520-06  
65 mm

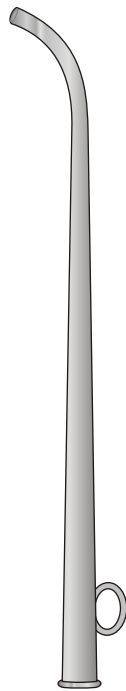

- 16-560-01 Ø 3,0 mm
- 16-560-02 Ø 3,5 mm
- 16-560-03 Ø 4,0 mm
- 16-560-04 Ø 4,5 mm
- 16-560-05 Ø 5,0 mm

ITARD  
16-560  
145 mm

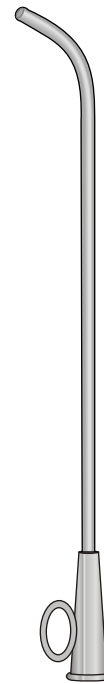

- 16-570-01 Ø 2,0 mm
- 16-570-02 Ø 2,5 mm
- 16-570-03 Ø 3,0 mm
- 16-570-04 Ø 3,5 mm
- 16-570-05 Ø 4,0 mm
- 16-570-06 Ø 4,5 mm
- 16-570-07 Ø 5,0 mm

HARTMANN  
16-570  
150 mm

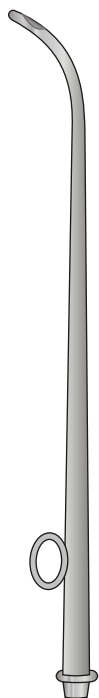

- 16-580-01 Ø 1,5 mm
- 16-580-02 Ø 1,7 mm
- 16-580-03 Ø 2,0 mm
- 16-580-04 Ø 2,5 mm
- 16-580-05 Ø 3,0 mm

SIEBENMANN  
16-580  
150 mm

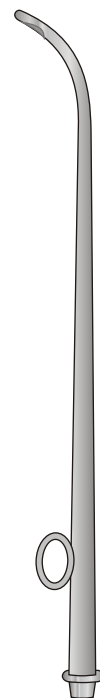

- 16-590-01 Ø 1,5 mm
- 16-590-02 Ø 1,7 mm
- 16-590-03 Ø 2,0 mm
- 16-590-04 Ø 2,5 mm
- 16-590-05 Ø 3,0 mm



SIEBENMANN  
16-590  
150 mm

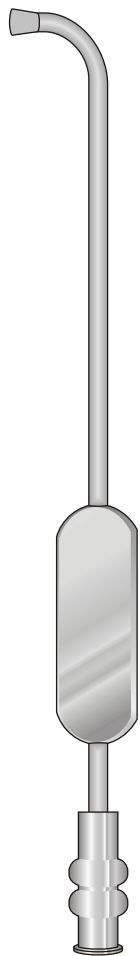

KILLIAN  
16-600-01 Ø 3 mm  
16-600-02 Ø 4 mm  
145 mm  
16-600

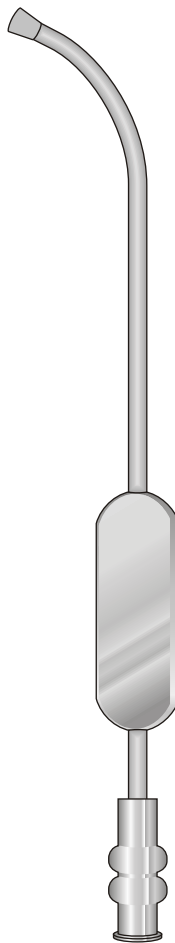

KILLIAN  
16-600-03 Ø 3 mm  
16-600-04 Ø 4 mm  
145 mm

Ø Interno  
Ø Inside  
Ø Innen  
Ø Intérieur  
Ø Interior

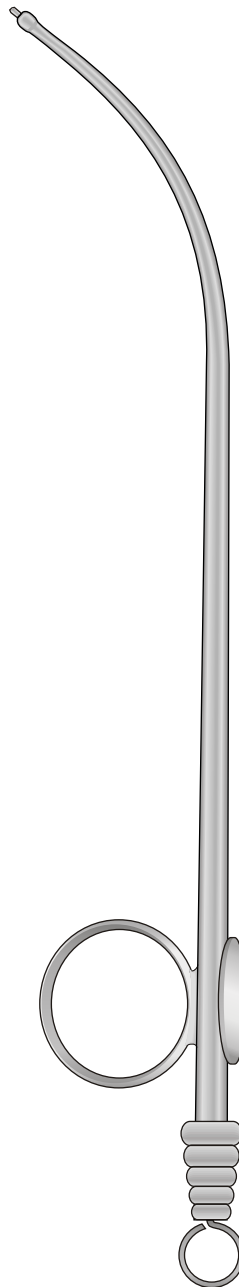

MAGILL  
16-610-01 Ø 1 mm  
200 mm

Ø Interno  
Ø Inside  
Ø Innen  
Ø Intérieur  
Ø Interior

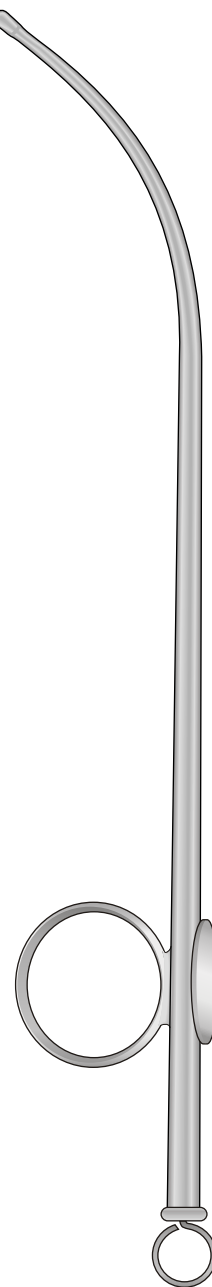

MAGILL  
16-610-02 Ø 1 mm  
16-610-03 Ø 2 mm  
16-610-04 Ø 3 mm  
200 mm  
16-610

Steriliser bar  
Autoclavable  
Autoclavabile  
Esterilizabile  
Stérilisable

Handwaschbürste  
Nail brush  
Spazzola per unghie  
Cepillo de uñas  
Brosse à ongles

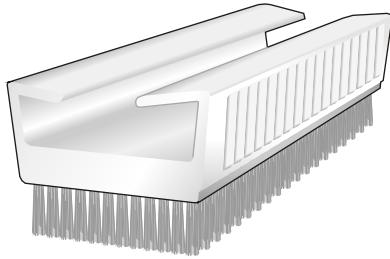

16-640-00  
4 x 11 cm

Scovolini per pulizia canule  
Kanülenreinigungs-bürsten

Ø Est. 8 mm  
Ø Int. 6 mm  
1/1

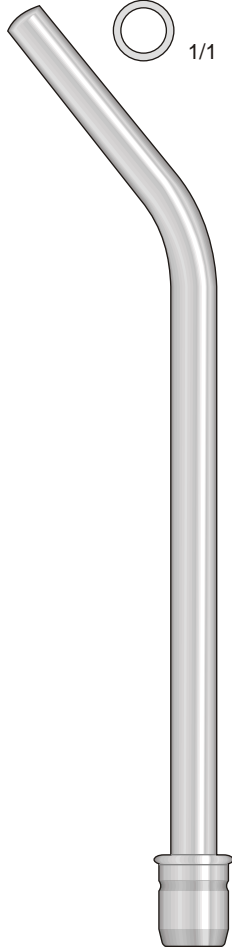

PELTON-CRANE  
16-620-14  
140 mm

Ø Est. 5 mm  
Ø Int. 2,5 mm  
1/1

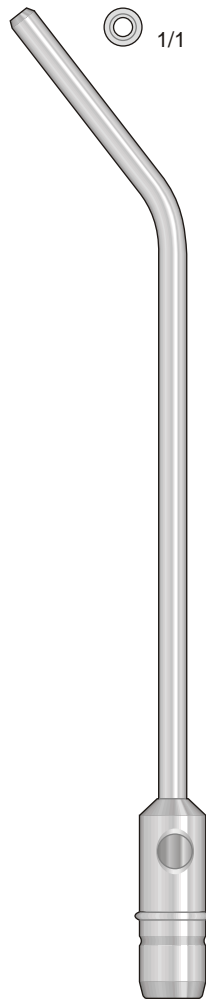

PELTON-CRANE  
16-620-16  
160 mm

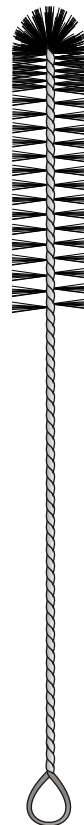

16-630-01  
120 mm



16-630-02  
235 mm

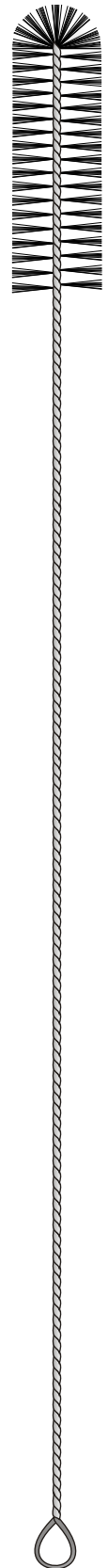

16-630-03  
330 mm

Sonde per varici, malleabili - Probe for varicose veins, malleable  
Krampfadersonden, biegsam - Sondes pour varices, malléables  
Sondas para vârices, maleables

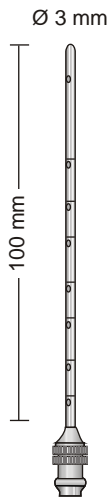

16-650-00  
FRAZIER

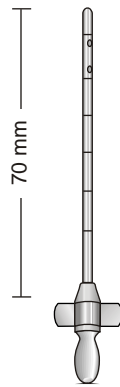

16-650-01 - Ø 2 mm  
16-650-02 - Ø 2,5 mm

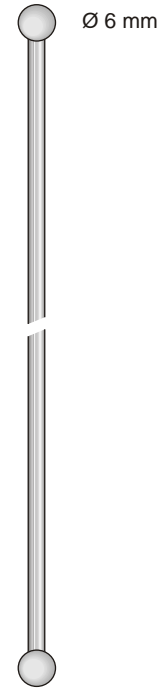

BABCOCK

16-660-01 - 400 mm  
16-660-02 - 500 mm  
16-660-03 - 650 mm  
16-660-04 - 800 mm

Aghi per tonsille  
Tonsil needles  
Tonsillenkanülen  
Aiguilles pour les amygdales  
Agujas para amígdalas



16-670-01  
120 mm

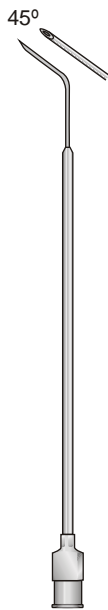

16-670-02  
110 mm



16-670-03  
110 mm

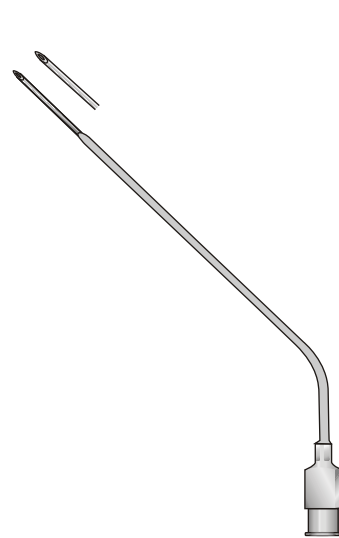

SEPTUN-NADEL  
16-670-04  
110 mm

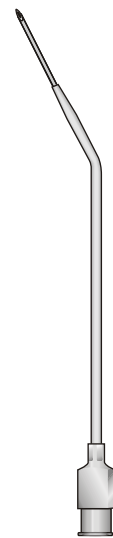

16-670-05  
110 mm

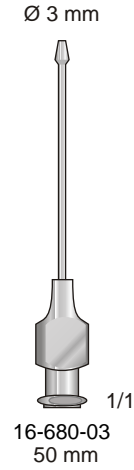
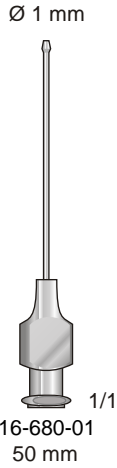

Canule per irrigazione dei vasi, malleabili  
Vessel irrigating cannulas, malleable  
Gefäß-spülkanülen, biegsam  
Canules d'irrigation pour vaisseaux, malléables  
Cánulas de irrigacion para vasos, maleables

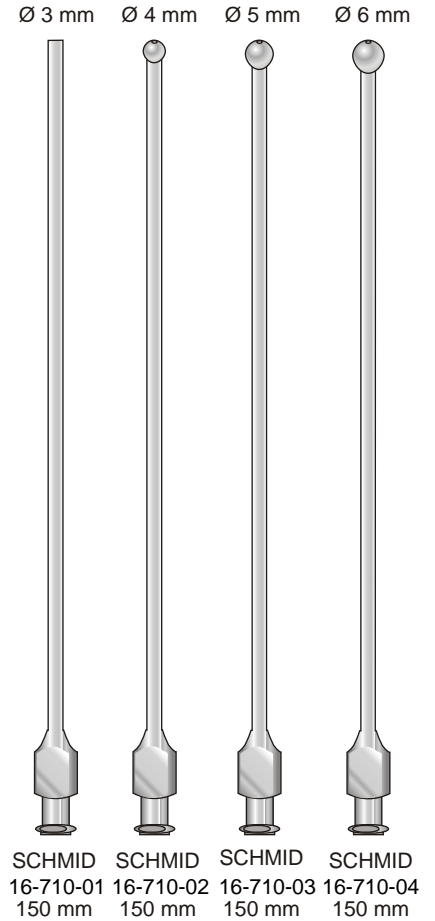
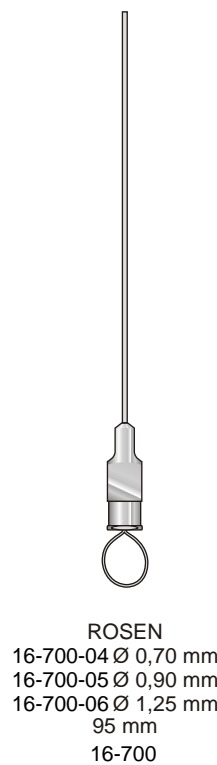
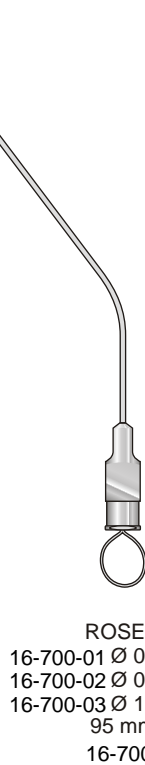
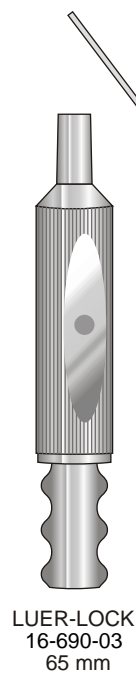
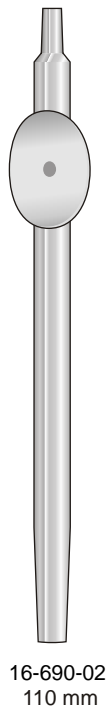
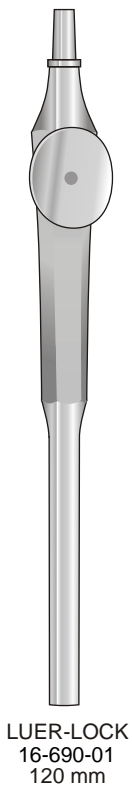



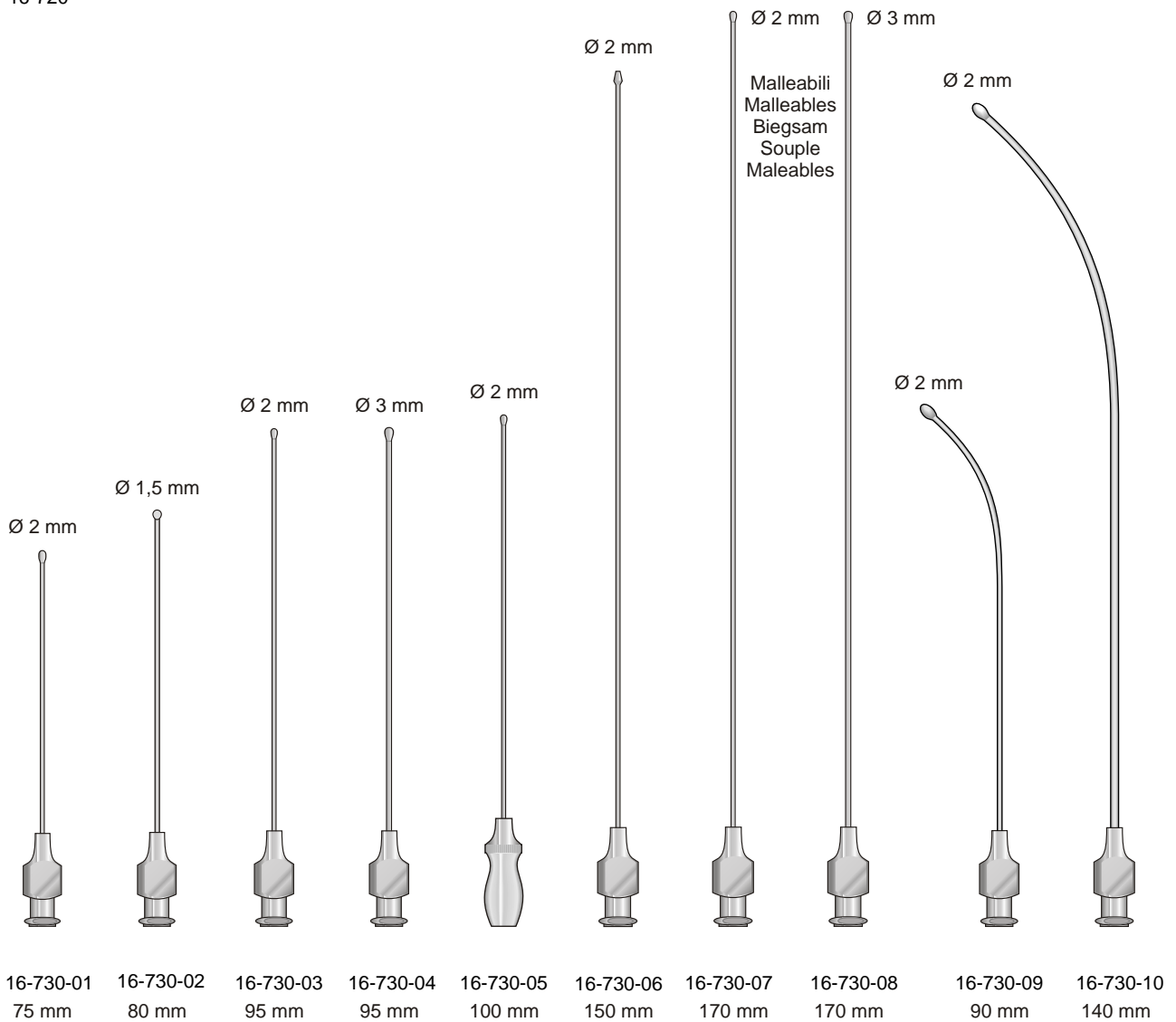
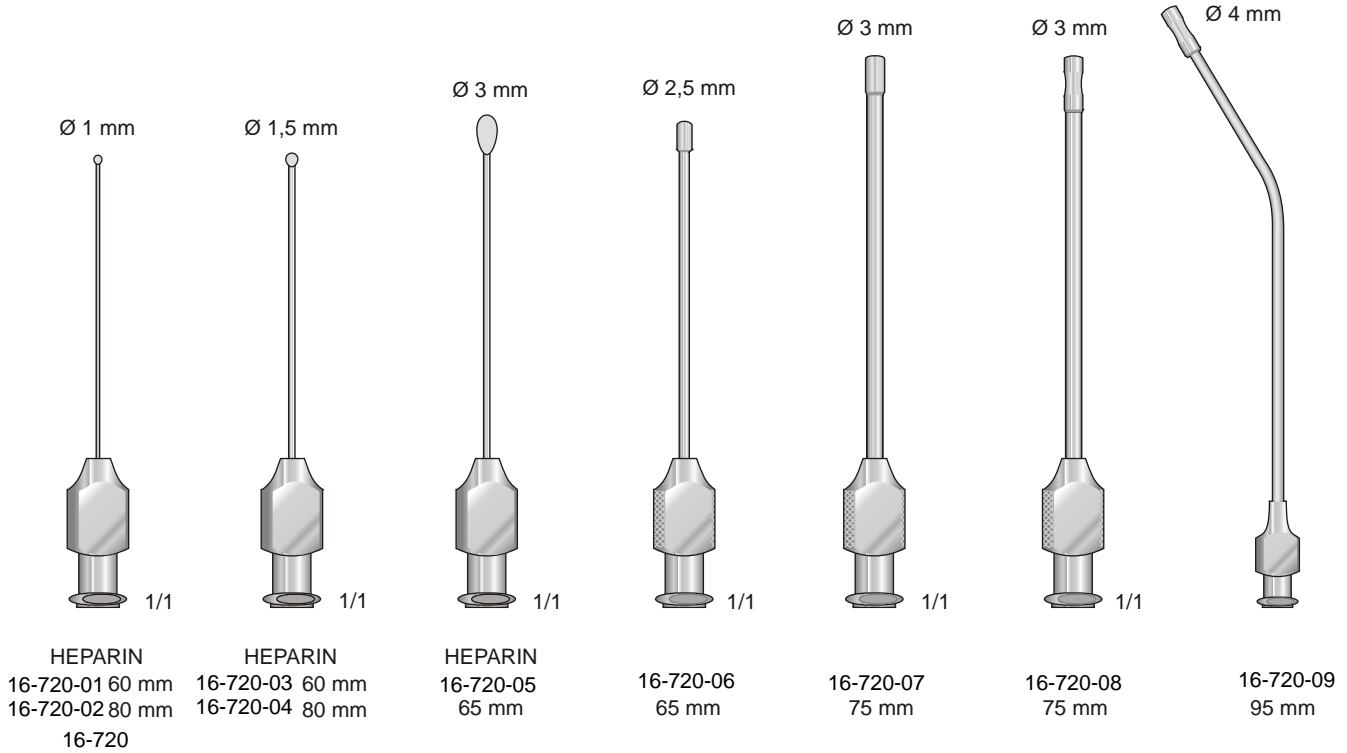

**Aghi malleabili**

0,5 mm



16-740-01  
150 mm

0,7 mm



16-740-02  
150 mm

1 mm



16-740-03  
150 mm

1,5 mm



16-740-04  
150 mm

2 mm



16-740-05  
150 mm

2,5 mm

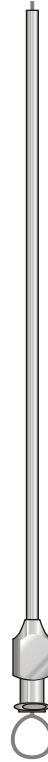

16-740-06  
150 mm

3 mm



16-740-07  
150 mm

**Aghi malleabili con due fori**

0,5 mm



16-740-08  
150 mm

0,7 mm



16-740-09  
150 mm

1 mm



16-740-10  
150 mm

1,5 mm



16-740-11  
150 mm

2 mm



16-740-12  
150 mm

2,5 mm



16-740-13  
150 mm

3 mm



16-740-14  
150 mm

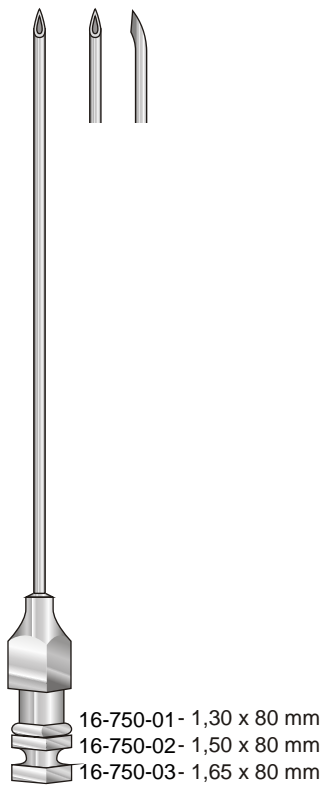

TUOHY  
16-750



QUINCKE  
16-760

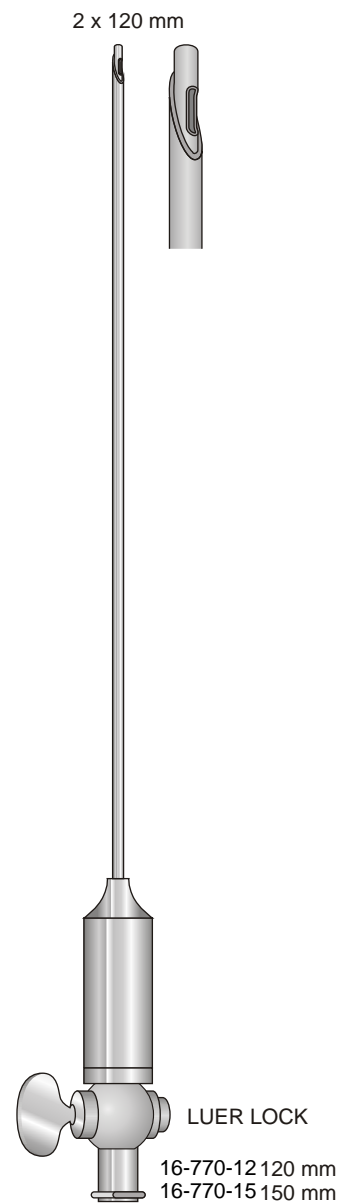

VERRES  
16-770