

Raspatorien  
Periosteals (Raspatories)  
Scollaperiostei (Periostotomi)  
Periostótomos (Legras)  
Rugines périostiques

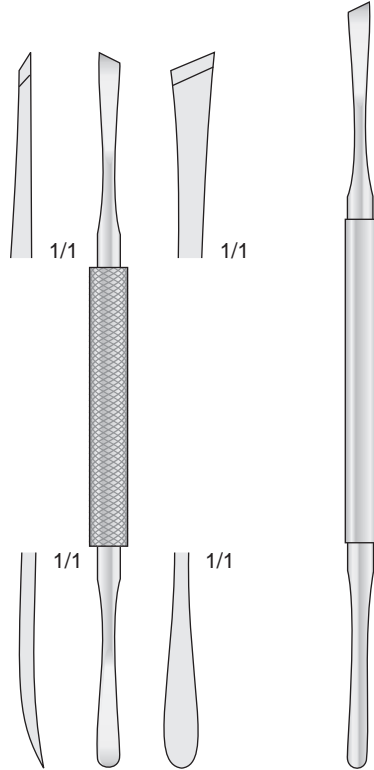

58-100-16  
165 mm

58-110-18  
185 mm

**PERIOSTEAL  
ELEVATORS**

**PERIOSTEAL  
RASPATORIES**

Scharf - Sharp - Taglienti - Cortante - Tranchant

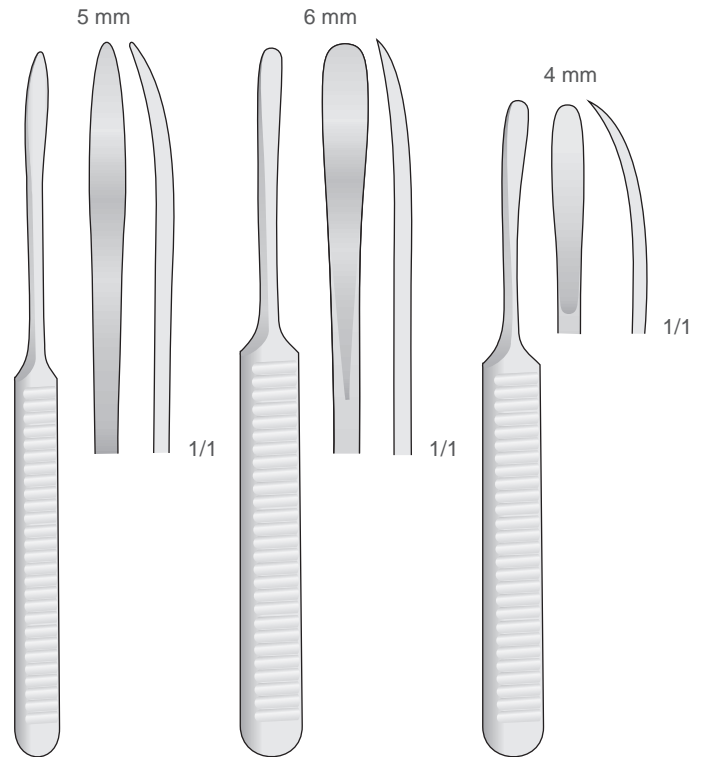
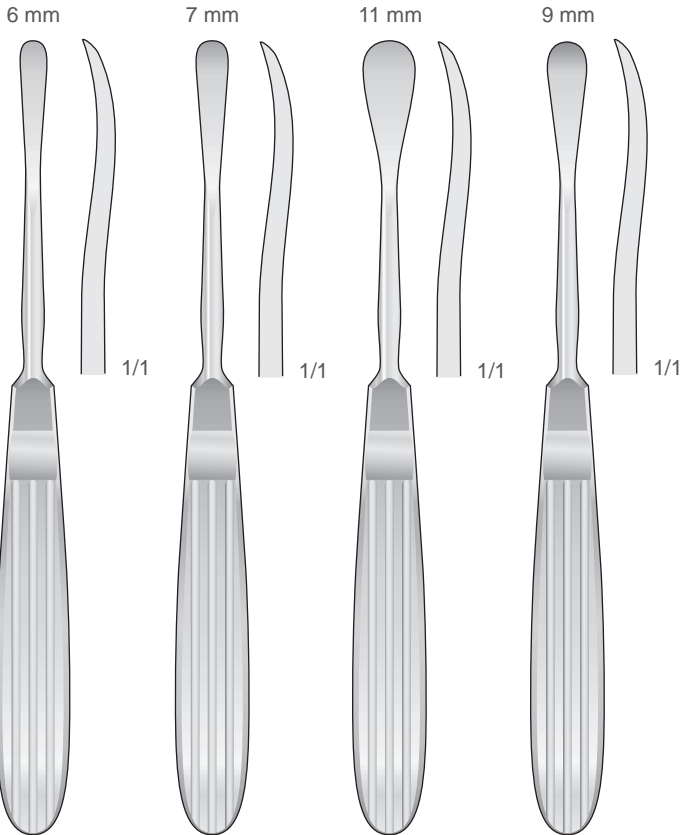

OBWEGESER

OBWEGESER

OBWEGESER

OBWEGESER

WILLIGER

WILLIGER

WILLIGER

58-120-01  
175 mm

58-120-02  
175 mm

58-120-03  
175 mm

58-120-04  
175 mm

58-130-01  
165 mm

58-130-02  
160 mm

58-130-03  
140 mm

Raspatorien  
Periosteals (Raspatories)  
Scollaperiostei (Periostotomi)  
Periostótomos (Legras)  
Rugines périostiques

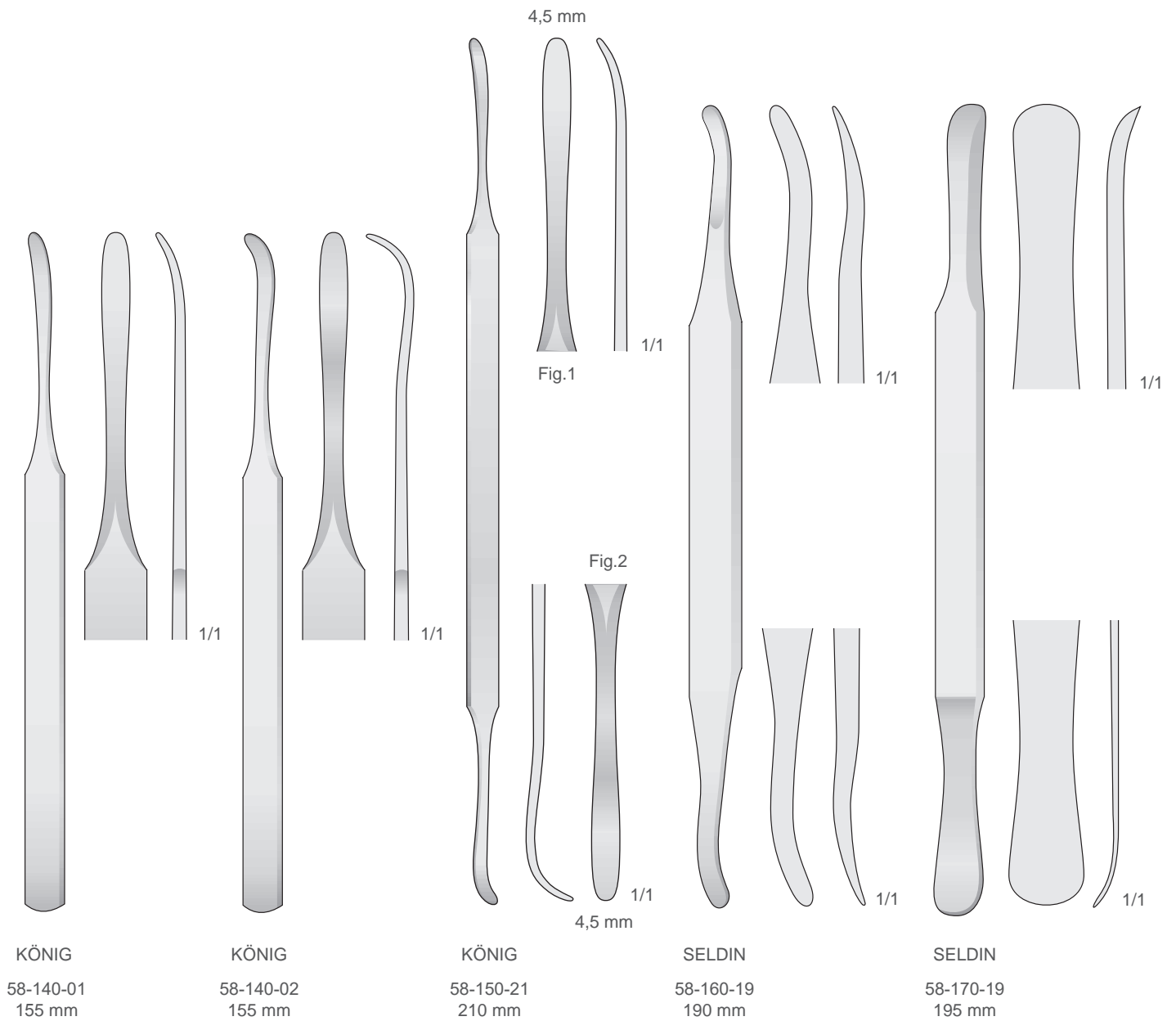

Raspatorien - Elevatoren  
Raspatories - Elevators  
Periostotomi - Elevatori  
Legras - Elevadores  
Rugines - Elevateurs

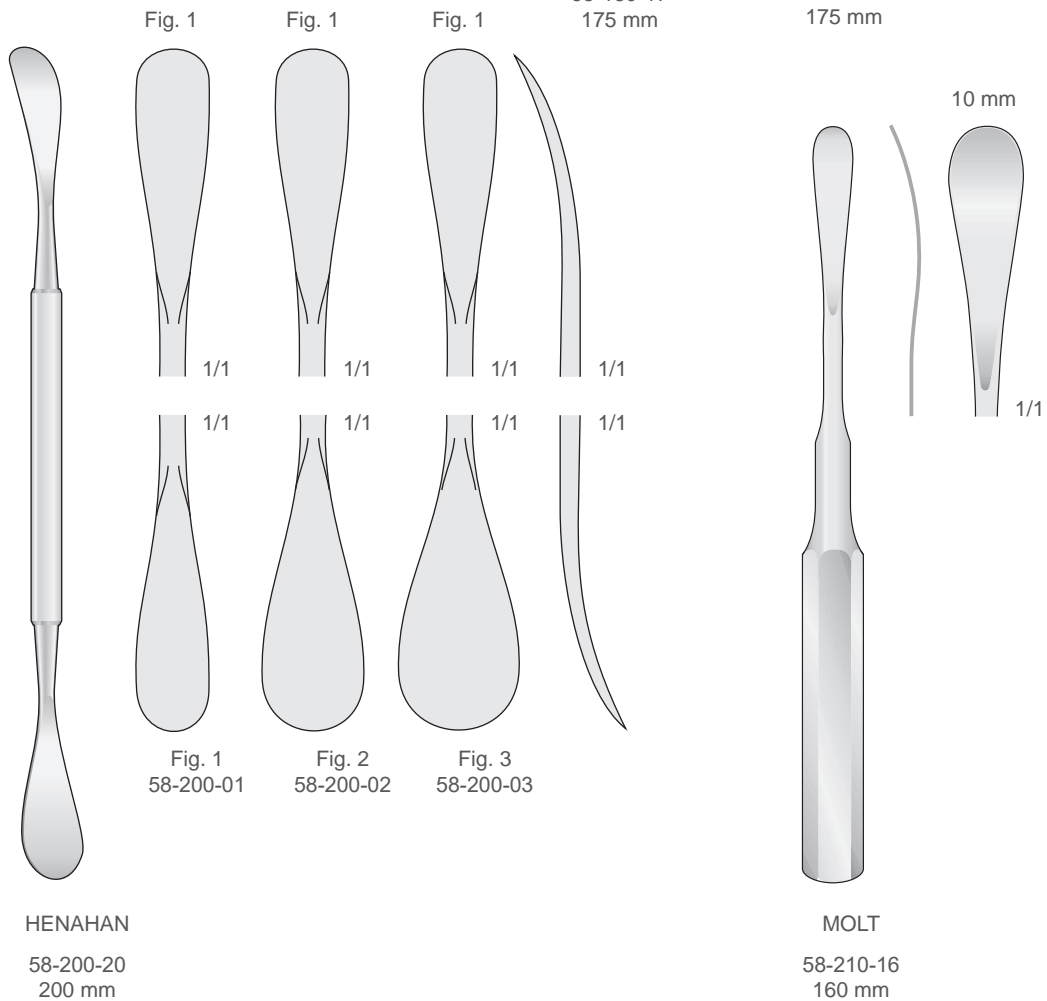
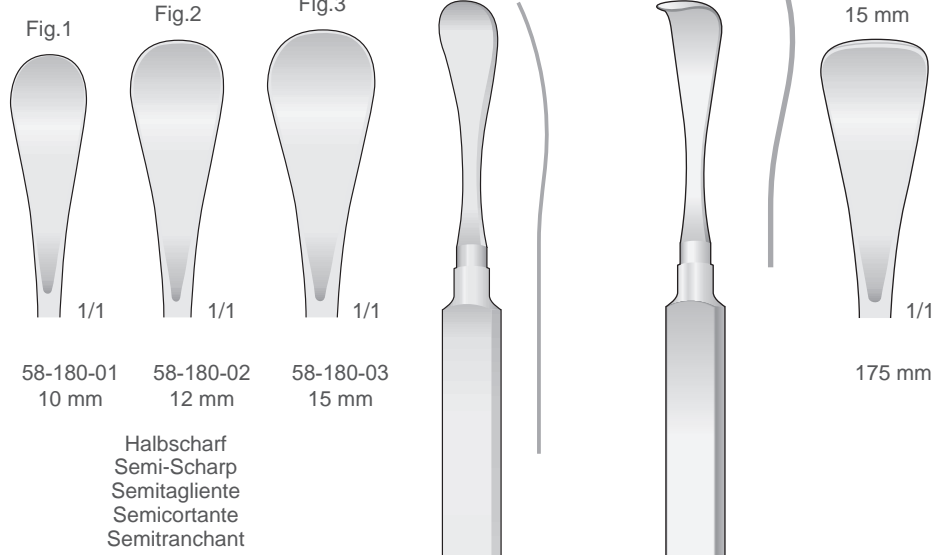

Raspatorien - Elevatorien  
 Raspatories - Elevators  
 Periostotomi - Elevatori  
 Legras - Elevadores  
 Rugines - Elevateurs

Fig. 12S

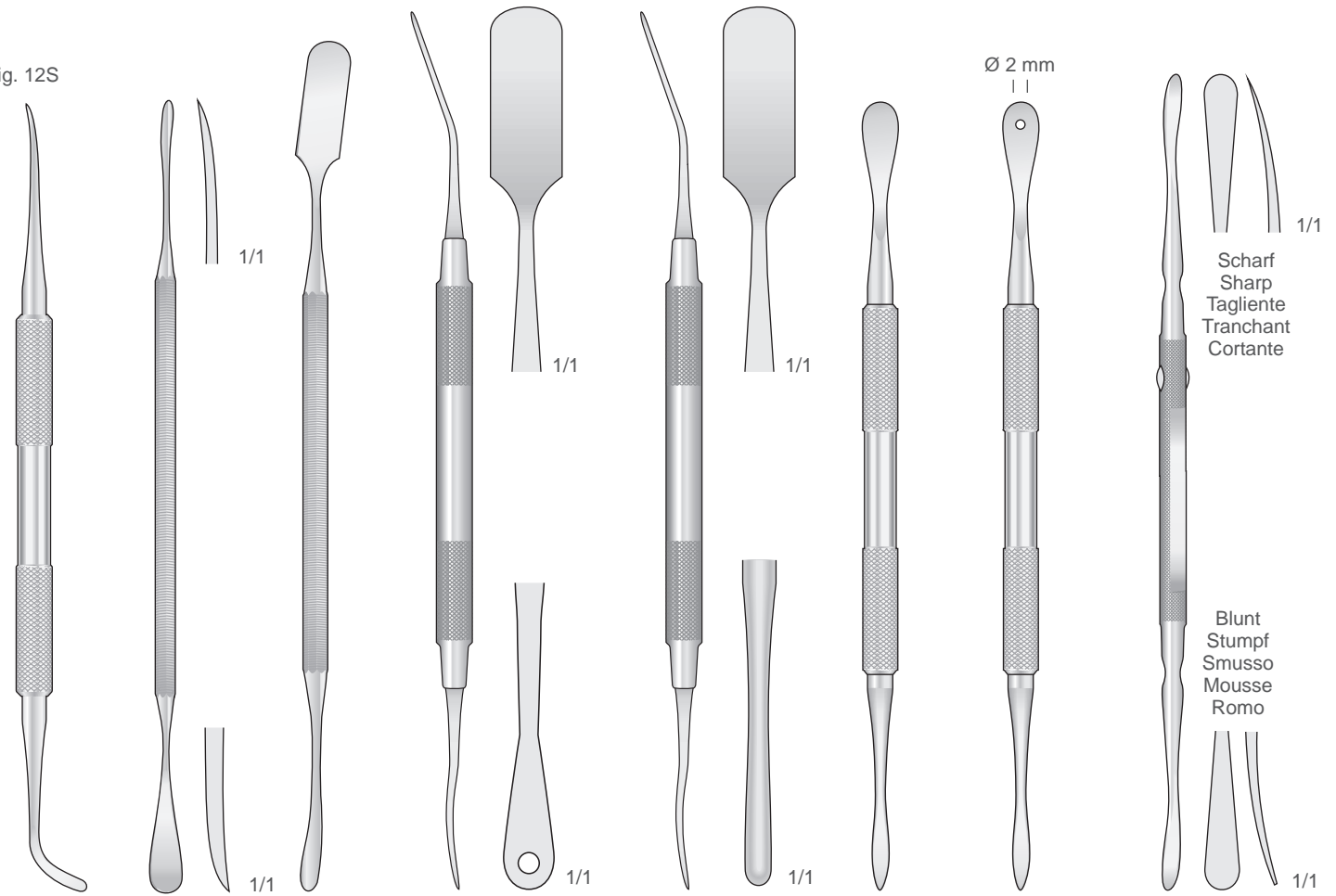

**BENNETT**

58-220-17  
175 mm

58-230-17  
175 mm

58-240-19  
190 mm

**PRICHARD**

58-250-18  
180 mm

**PRICHARD**

58-250-17  
175 mm

**MOLT**

58-260-01  
170 mm

**MOLT**

58-260-02  
170 mm

**FREER**

58-270-18  
180 mm

Raspatorien - Elevatorien  
Raspatorien - Elevators  
Periostotomi - Elevatori  
Legras - Elevadores  
Rugines - Elevateurs

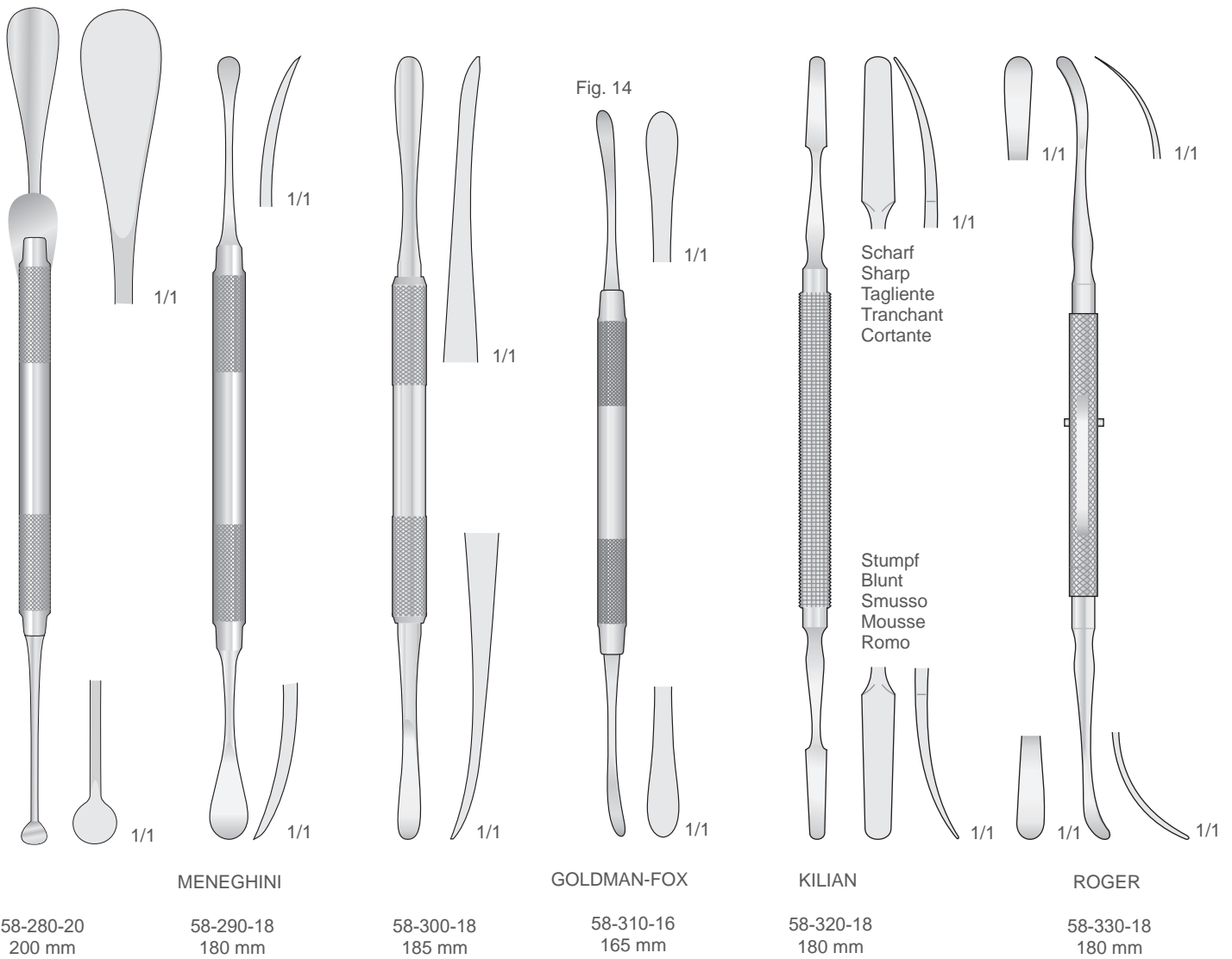

Raspatorien - Elevatorien  
 Raspatories - Elevators  
 Periostotomi - Elevatori  
 Legras - Elevadores  
 Rugines - Elevateurs

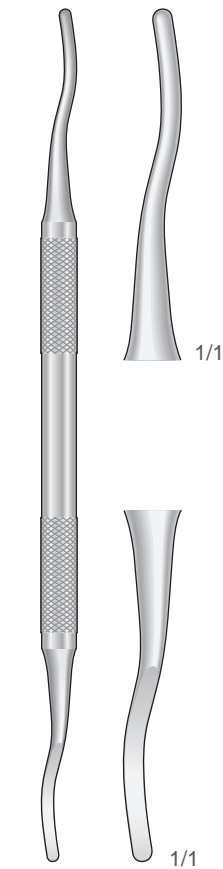

HOPKINS

58-340-01  
185 mm

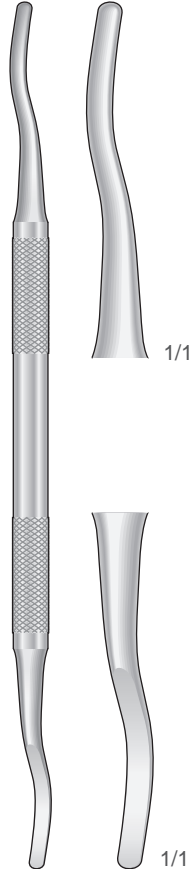

HOPKINS

58-340-02  
185 mm

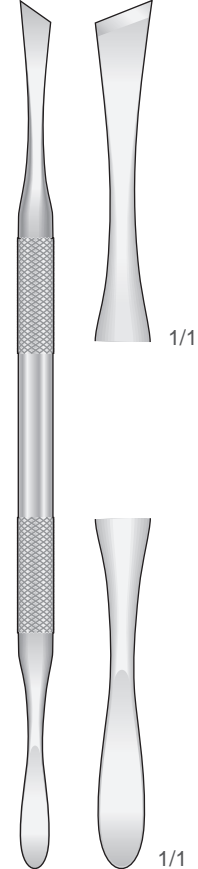

MEAD

58-350-18  
185 mm

Instrumente für Sinuslift / Sinus Lift Instruments / Strumenti per rialzo del seno  
 Instrumentos para elevación de seno maxilar / Instruments d'élévation sinusienne

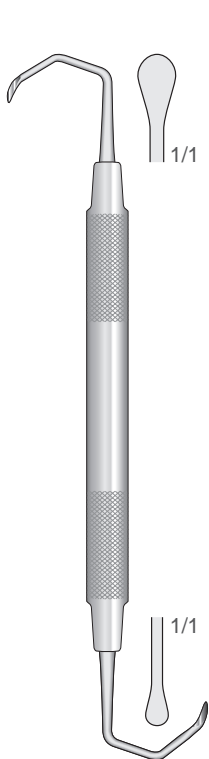

58-360-01  
160 mm

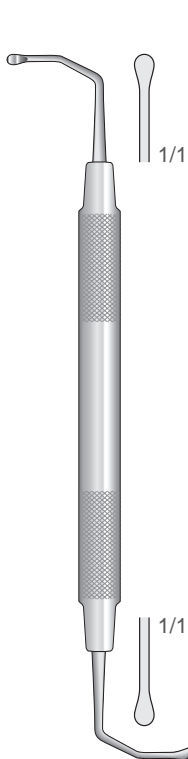

58-360-02  
160 mm

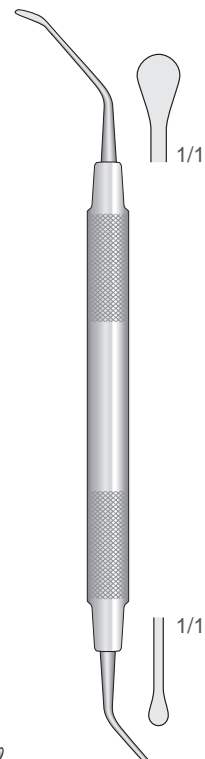

58-360-03  
180 mm

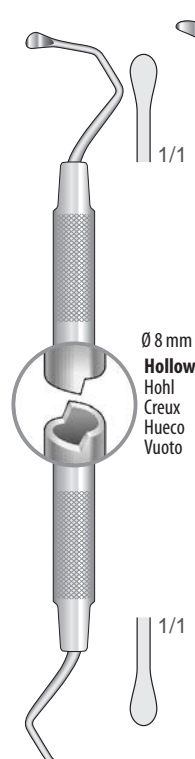

58-360-04  
170 mm

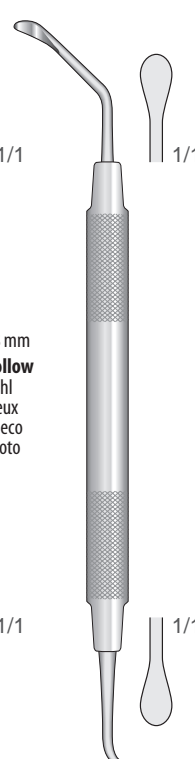

58-360-05  
175 mm

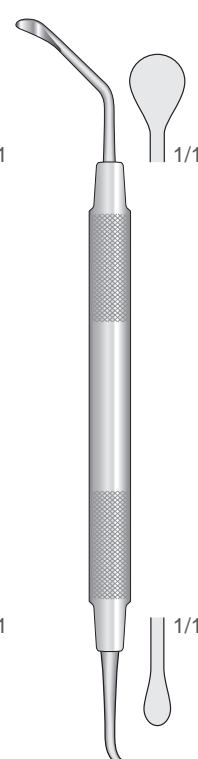

58-360-06  
175 mm

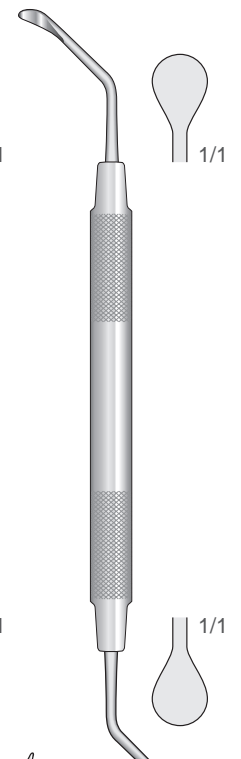

58-360-07  
180 mm

Ø 8 mm  
**Hollow**  
 Hohl  
 Creux  
 Hueco  
 Vuoto

Raspatorien - Elevatorien  
Raspatories - Elevators  
Periostotomi - Elevatori  
Legras - Elevadores  
Rugines - Elevateurs

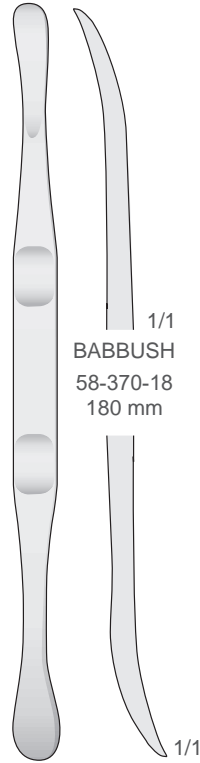

1/1  
BABBUSH  
58-370-18  
180 mm

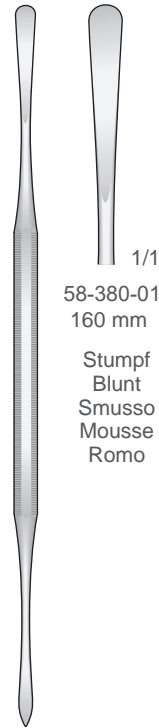

1/1  
58-380-01  
160 mm  
Stumpf  
Blunt  
Smusso  
Mousse  
Romo

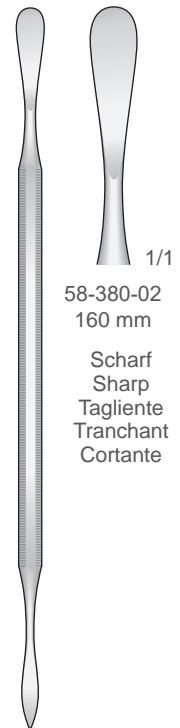

1/1  
58-380-02  
160 mm  
Scharf  
Sharp  
Tagliante  
Tranchant  
Cortante

Instrumente für Sinuslift  
Sinus Lift Instruments

Strumenti per rialzo del seno  
Instrumentos para elevación de seno maxilar  
Instruments d'élévation sinusienne

Fig. 24G

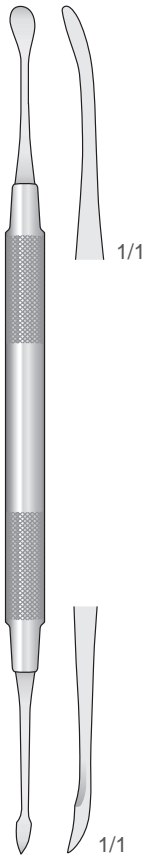

MOLT  
58-390-18  
180 mm

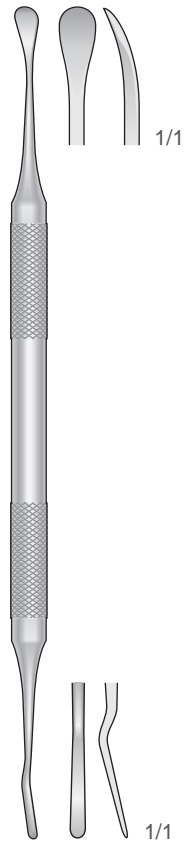

58-400-17  
175 mm

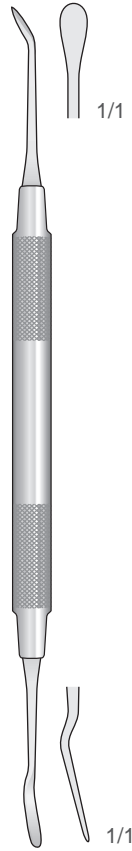

WOODSON  
58-410-17  
170 mm

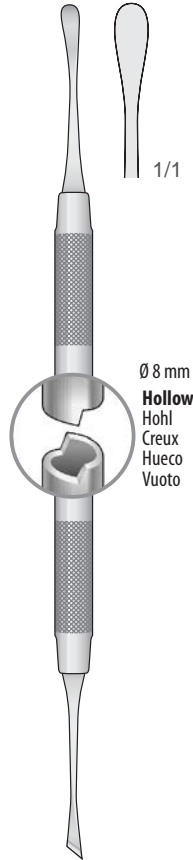

Ø 8 mm  
Hollow  
Hohl  
Creux  
Hueco  
Vuoto

58-420-01  
175 mm

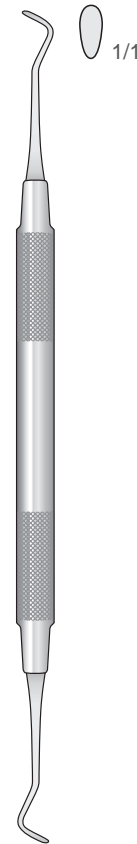

58-420-02  
175 mm

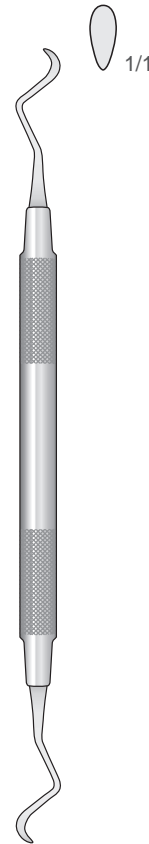

58-420-03  
165 mm

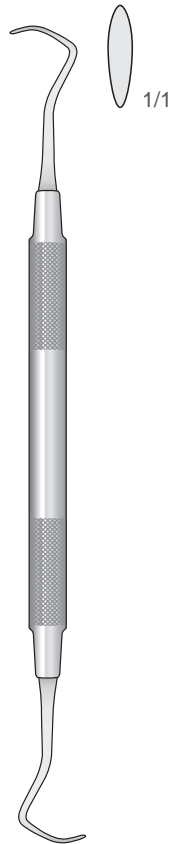

58-420-03  
170 mm

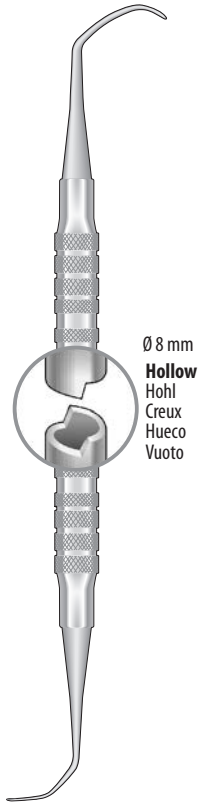

58-430-01

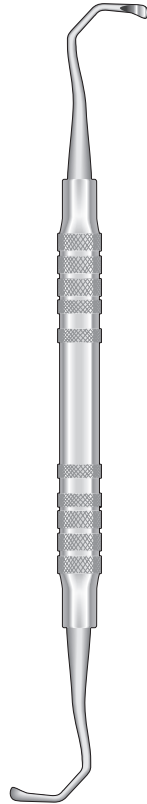

58-430-02

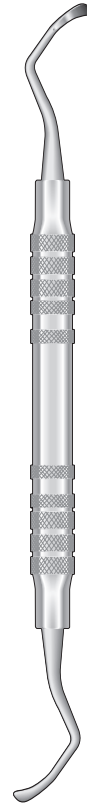

58-430-03

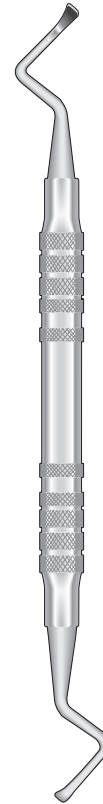

58-430-04



58-430-05



58-430-06



58-430-07

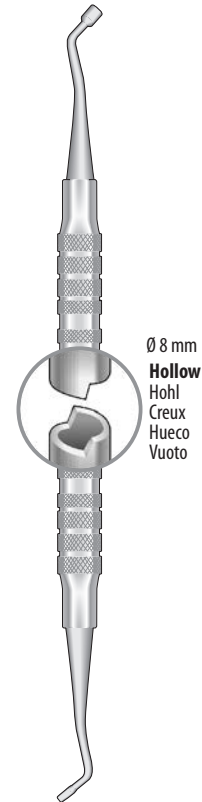

58-430-08



Raspatorien  
Raspatories  
Periostotomi  
Legras  
Rugines

Curettes  
Küretten  
Curettes  
Curetas  
Curettes

Instrumente für Sinuslift  
Sinus Lift Instruments  
Strumenti per rialzo del seno  
Instrumentos para elevación de seno maxilar  
Instruments d'élévation sinusienne

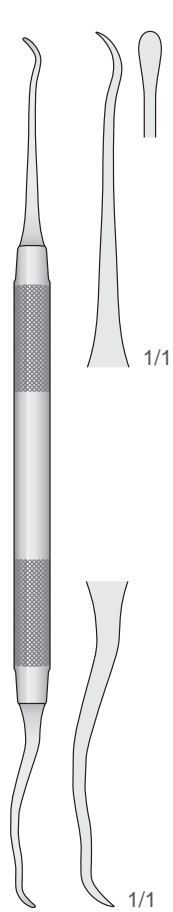
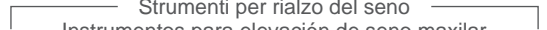

MILLER-COLBURN

58-450-18  
185 mm

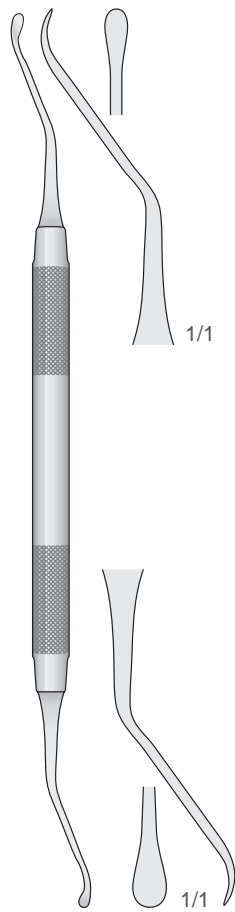

MOLT

58-460-19  
190 mm

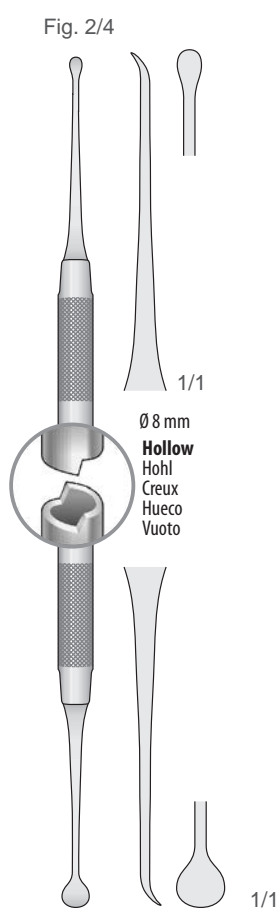

MOLT

58-460-18  
180 mm

Ø 8 mm  
**Hollow**  
Hohl  
Creux  
Hueco  
Vuoto

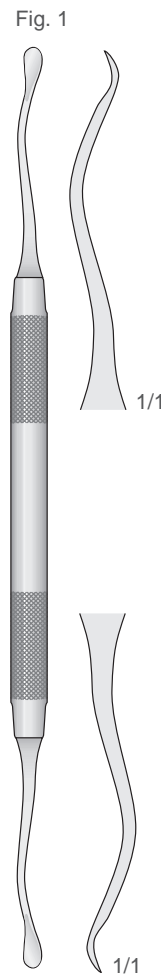

58-470-20  
200 mm

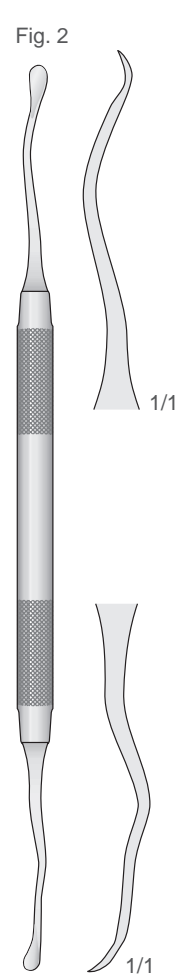

58-470-19  
195 mm

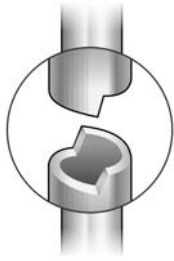

Runder Hohlgriff 8 mm  
Hollow Round Handle 8 mm  
Manico tondo vuoto 8 mm  
Mango hueco 8 mm  
Manche rond vide 8 mm

Küretten  
Curettes  
Curettes  
Curetas  
Curettes

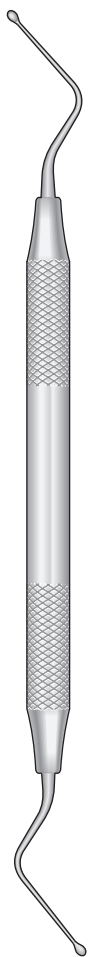

HEMINGWAY  
58-480-18  
180 mm

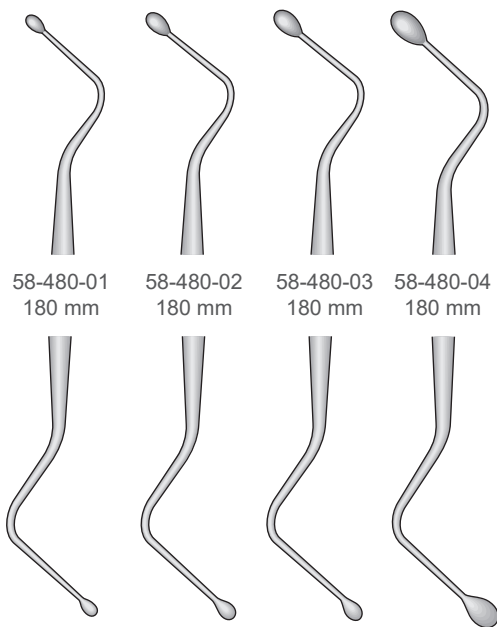

58-480-01 180 mm  
58-480-02 180 mm  
58-480-03 180 mm  
58-480-04 180 mm

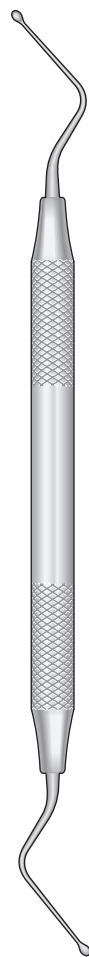

LUCAS  
58-490-18  
180 mm

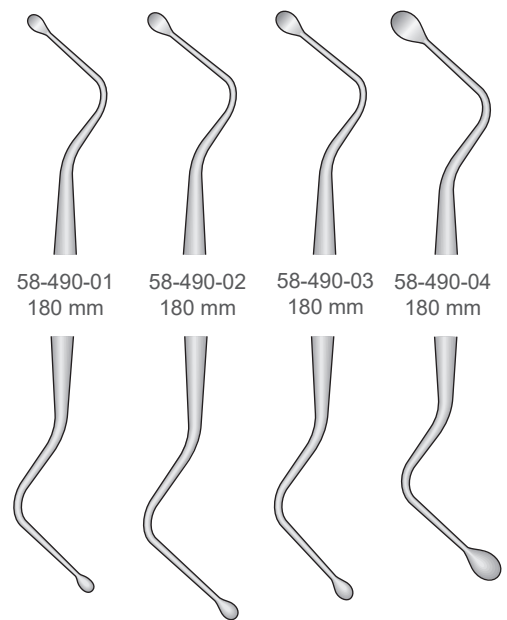

58-490-01 180 mm  
58-490-02 180 mm  
58-490-03 180 mm  
58-490-04 180 mm

Küretten  
Curettes  
Curettes  
Curetas  
Curettes

Wundhachen Mandibular  
Mandibular Nerve Diplace  
Per spostamento  
nervo mandibolare  
Para nero mandibular

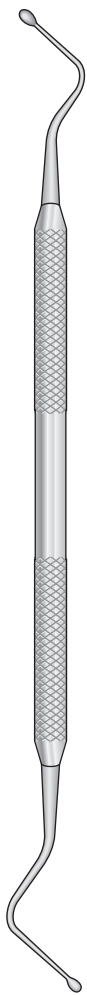

HEMINGWAY

58-500-01  
170 mm

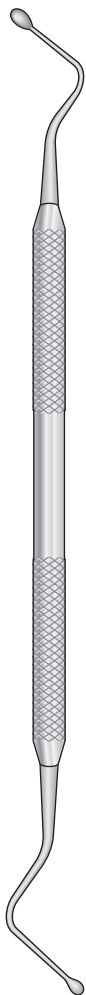

HEMINGWAY

58-500-02  
170 mm

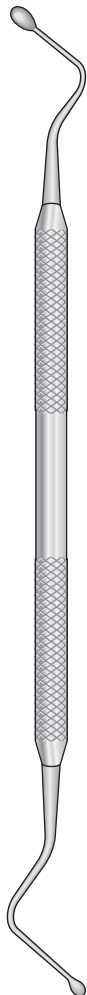

HEMINGWAY

58-500-03  
170 mm

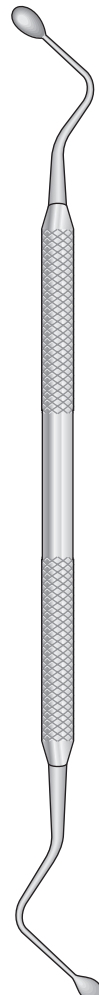

HEMINGWAY

58-500-04  
170 mm

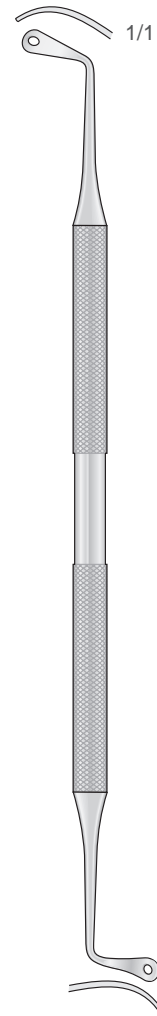

58-500-05  
165 mm

Küretten  
Curettes  
Curettes  
Curetas  
Curettes

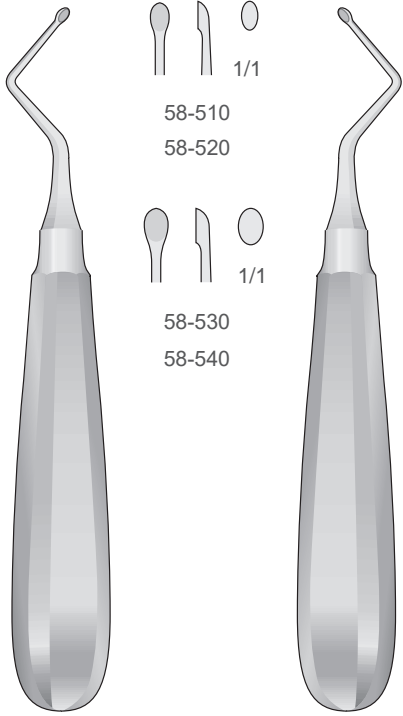

KERPEL

58-510  
58-520  
145 mm

KERPEL

58-520  
58-540  
145 mm



58-550-15  
155 mm

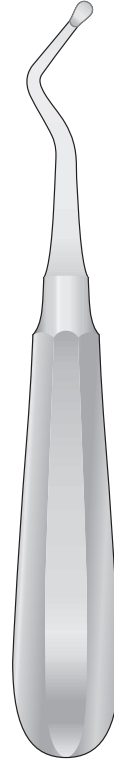

58-560-01  
150 mm

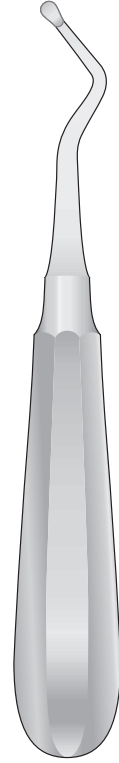

58-560-02  
150 mm

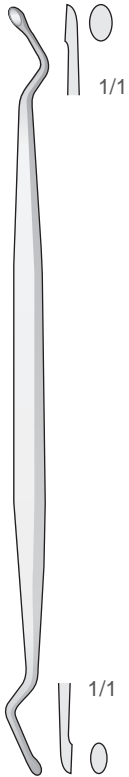

58-570-16  
160 mm

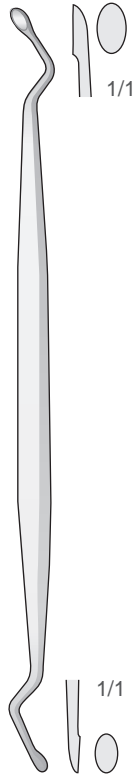

JANSEN  
58-580-16  
160 mm

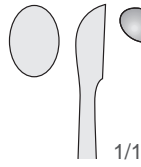

UFFENORDE  
58-590-01  
170 mm

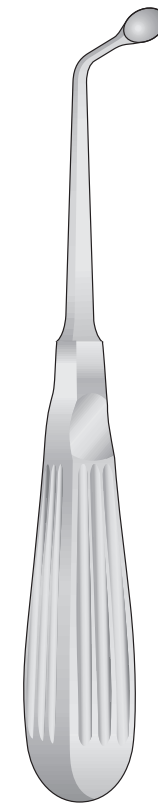
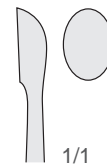

UFFENORDE  
58-590-02  
170 mm

Fig. 00  
3,4 mm  
1/1  
58-600-01  
Fig. 1  
5,2 mm  
1/1  
58-600-02

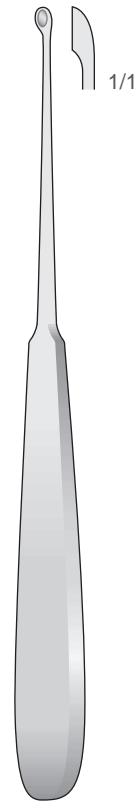

WILLIGER  
58-600  
170 mm

Küretten  
Curettes  
Curettes  
Curetas  
Curettes

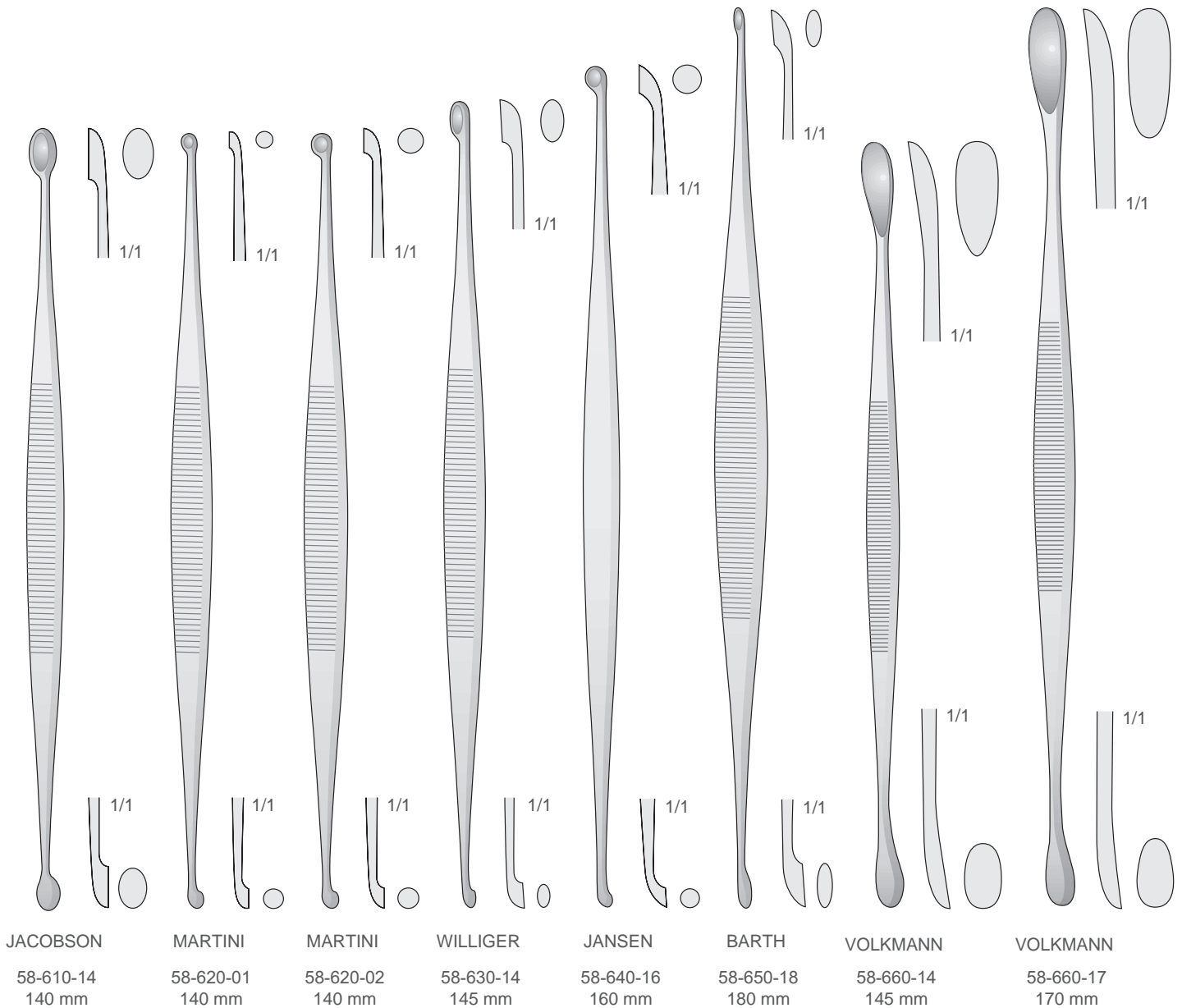

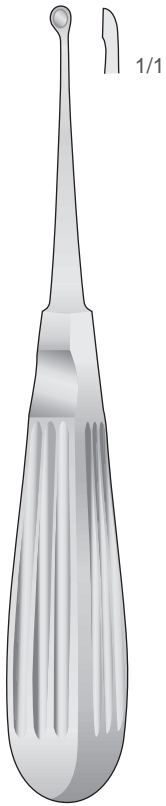

VOLKMANN  
58-670-17  
170 mm

Fig.0000  
2,8 mm  
1/1  
58-670-01

Fig.000  
3,6 mm  
1/1  
58-670-02

Fig.00  
4,4 mm  
1/1  
58-670-03

,Fig.0  
5,2 mm  
1/1  
58-670-04

Fig.1  
6,8 mm  
1/1  
58-670-05

Fig.2  
8,5 mm  
1/1  
58-670-06

Fig.3  
10 mm  
1/1  
58-670-07

Fig.4  
11,5 mm  
1/1  
58-670-08

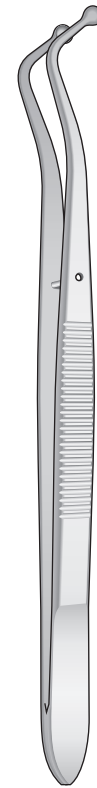

COLLEGE CURETTE  
58-690-16  
160 mm

Küretten  
Curettes  
Curettes  
Curetas  
Curettes

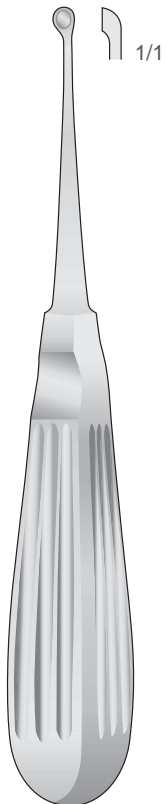

BRUNS  
58-680-16  
165 mm

3 mm 1/1 58-680-01	4 mm 1/1 58-680-02	5 mm 1/1 58-680-03
6 mm 1/1 58-680-04	8 mm 1/1 58-680-05	
10 mm 1/1 58-680-06	12 mm 1/1 58-680-07	

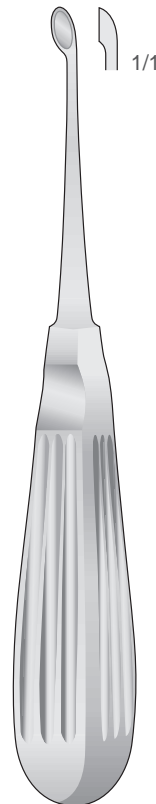

SCHEDE  
58-690-17  
170 mm

2,5 mm 1/1 58-690-01	3,4 mm 1/1 58-690-02	4,2 mm 1/1 58-690-03
5,2 mm 1/1 58-690-04	6,3 mm 1/1 58-690-05	
7,4 mm 1/1 58-690-06	8 mm 1/1 58-690-07	

Chirurgische Küretten  
Surgical Curettes  
Curette chirurgiche  
Curetas quirúrgicas  
Curettes chirurgicales

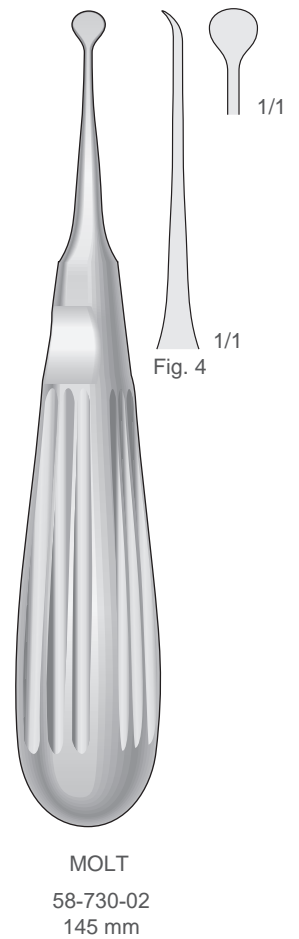
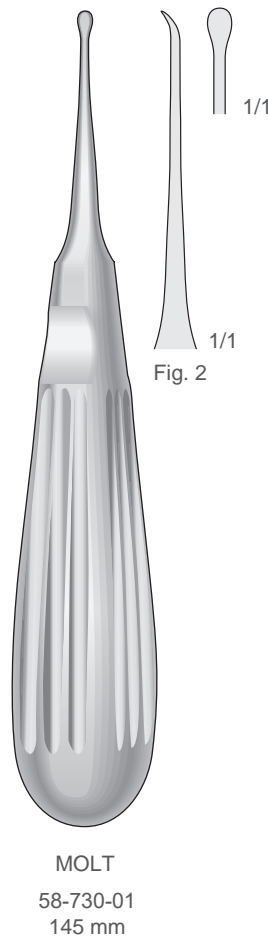
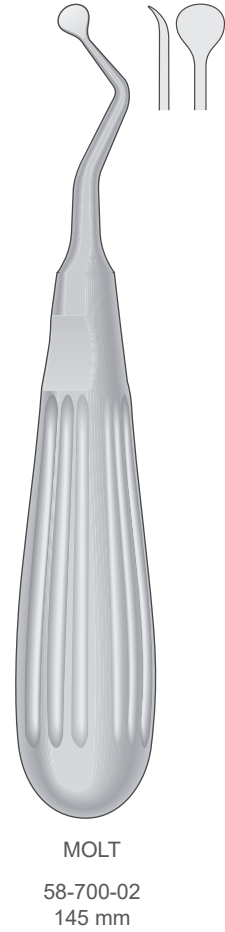
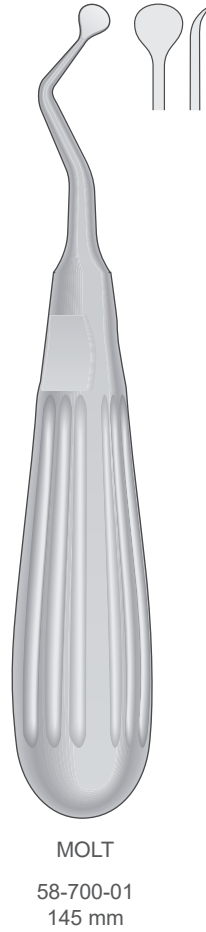
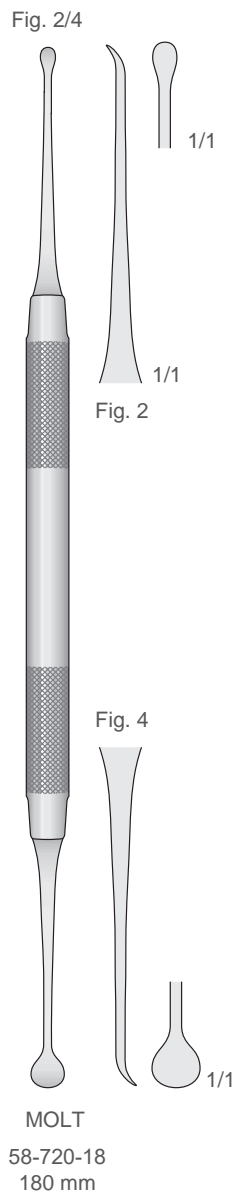
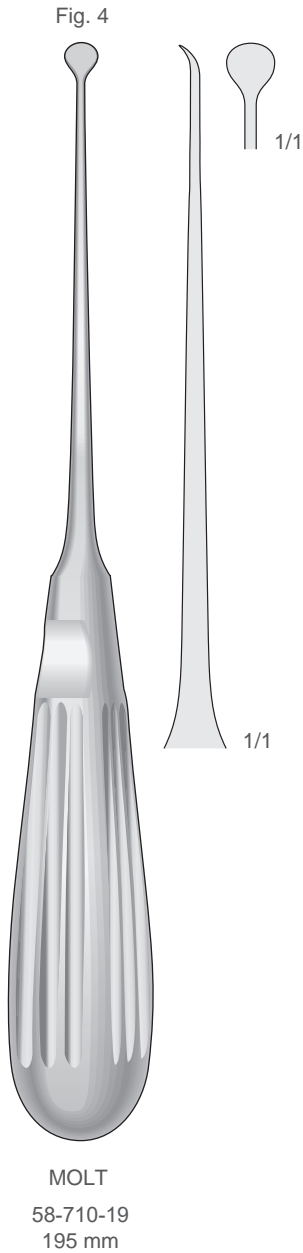

Knochenfeilen  
Bone Files  
Lime per osso  
Limas para hueso  
Limes à os

Fig. 67

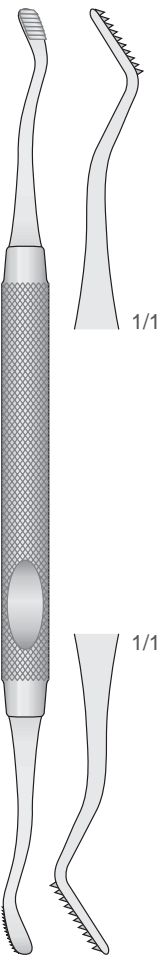

HOWARD

58-740-18  
180 mm

Fig. 45

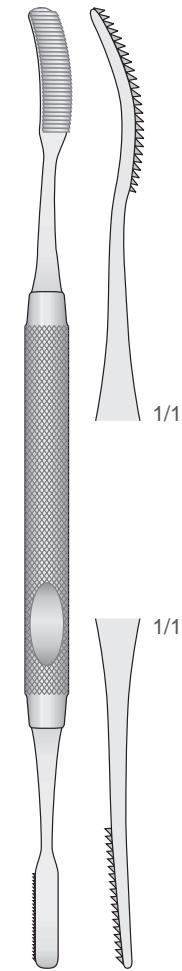

MILLER

58-750-01  
185 mm

Fig. 52

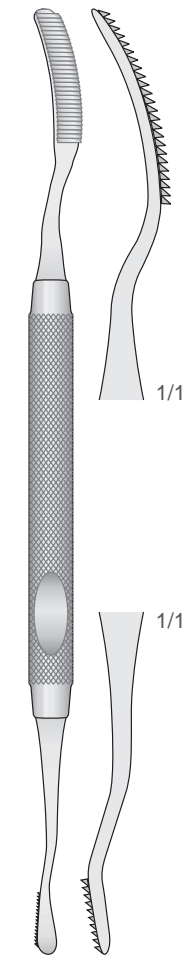

MILLER

58-750-02  
180 mm

Fig. 12

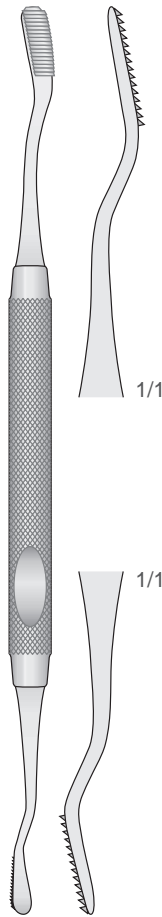

HOWARD

58-760-03  
170 mm

Fig. 12A

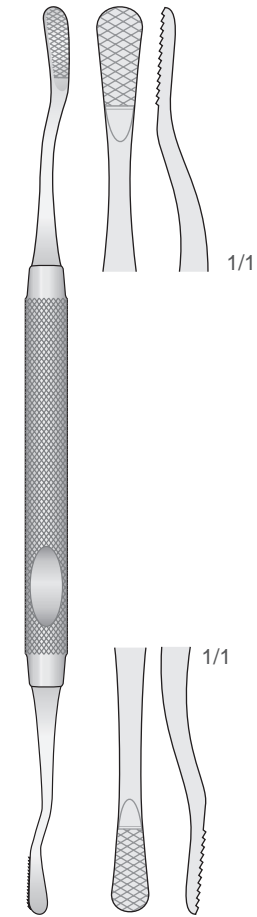

MILLER

58-770-17  
170 mm

Fig. 64

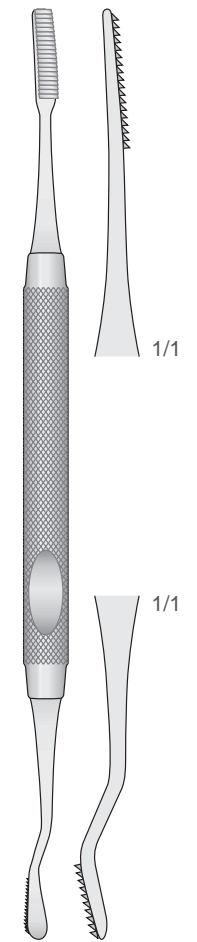

MILLER

58-780-17  
175 mm



Knochenfeilen  
Bone Files  
Lime per osso  
Limas para hueso  
Limes à os

Runder Hohlgriff 8 mm  
Hollow Round Handle 8 mm  
Manico tondo vuoto 8 mm  
Mango hueco 8 mm  
Manche rond vide 8 mm

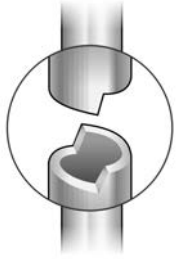

Parodontal Feilen  
Periodontal Files  
Lime parodontali  
Limas periodontales  
Limes parodontales

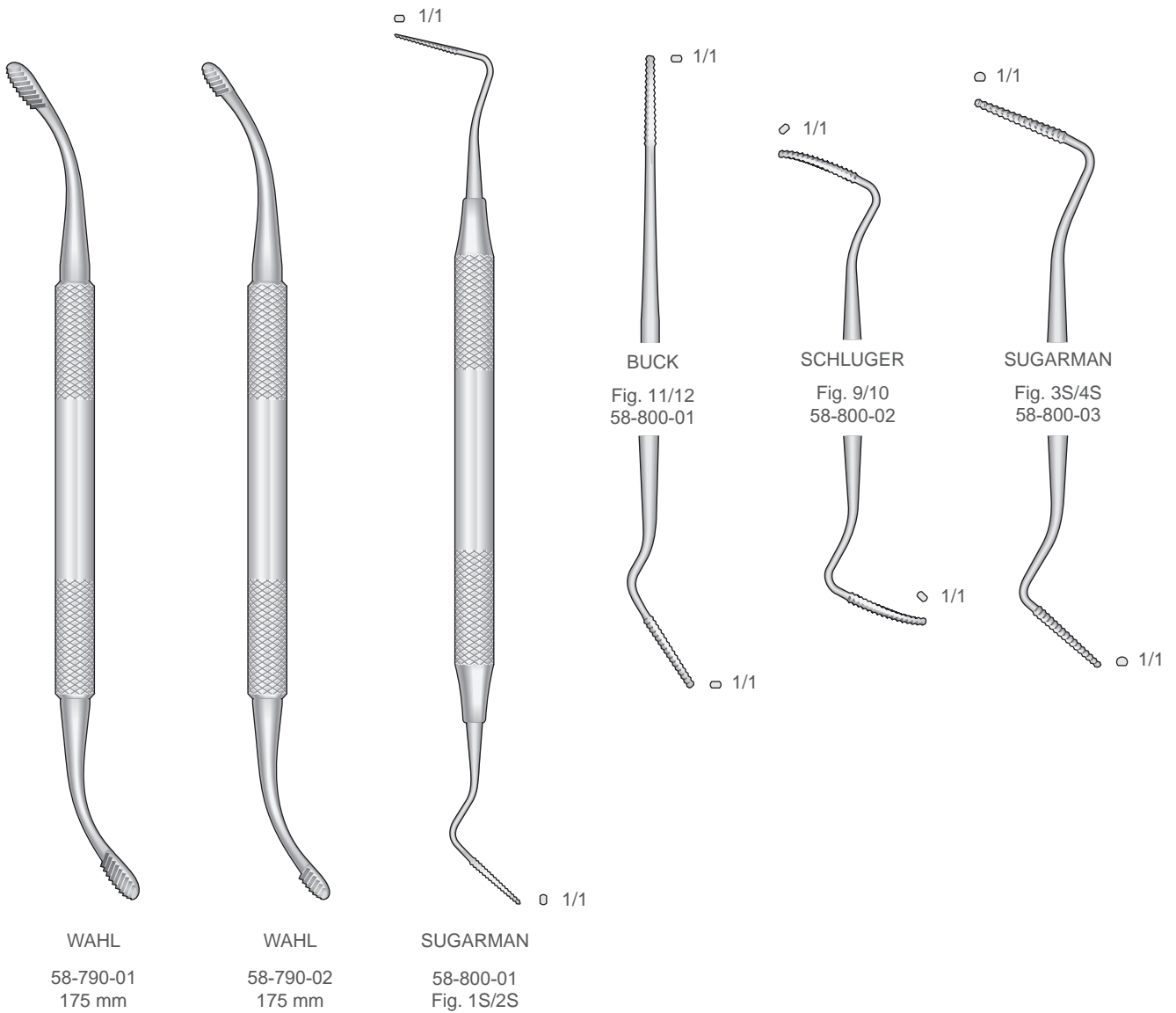

Gewebezängchen  
Tissue Nippers  
Tronchesi per gengive e tessuti  
Pinzas para cortar tejidos  
Pincas coupante pour tissue

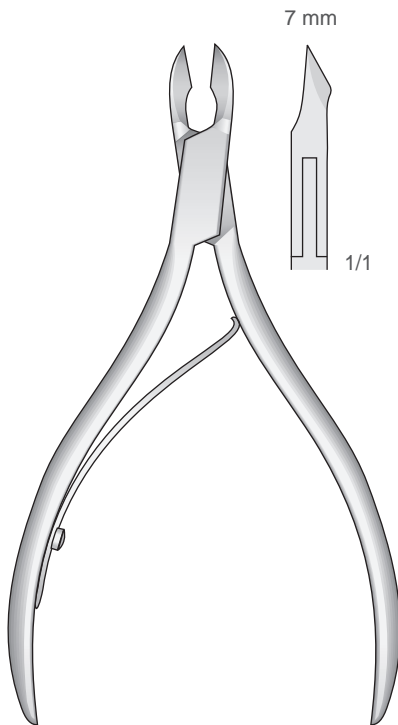

CHOEN  
58-810-10  
105 mm

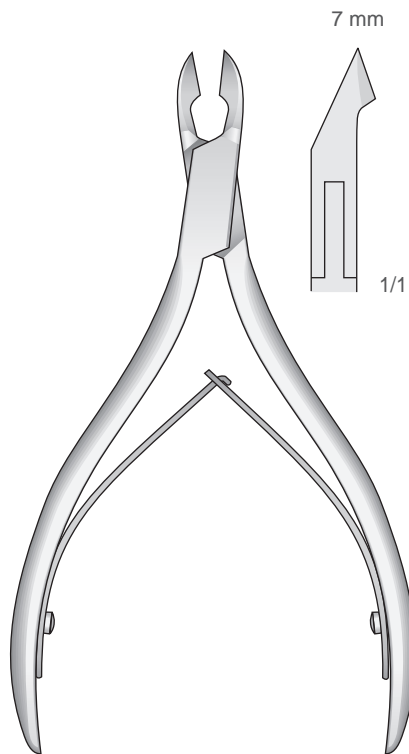

ILIC  
58-820-11  
115 mm

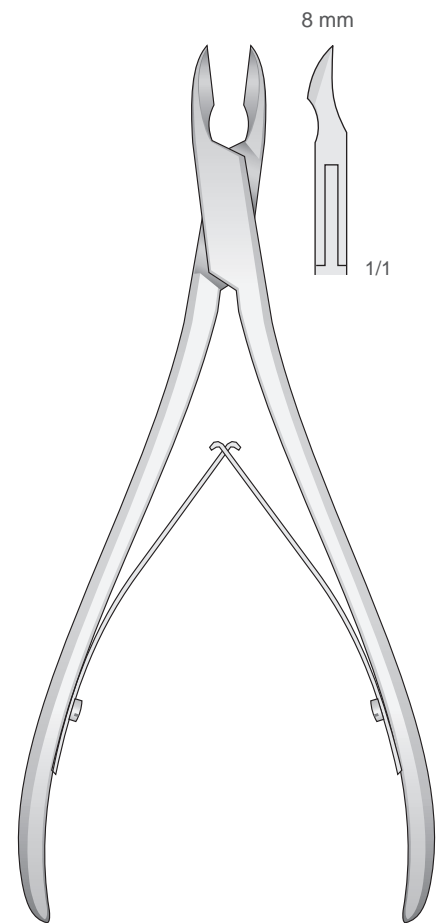

58-820-04  
140 mm

Hohlmeißelzangen  
Bone rongeurs  
Pinze ossivore  
Pinzas gubias  
Pincas gouges

S-Form

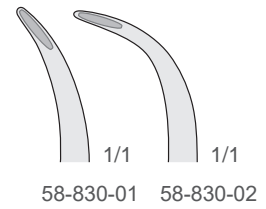
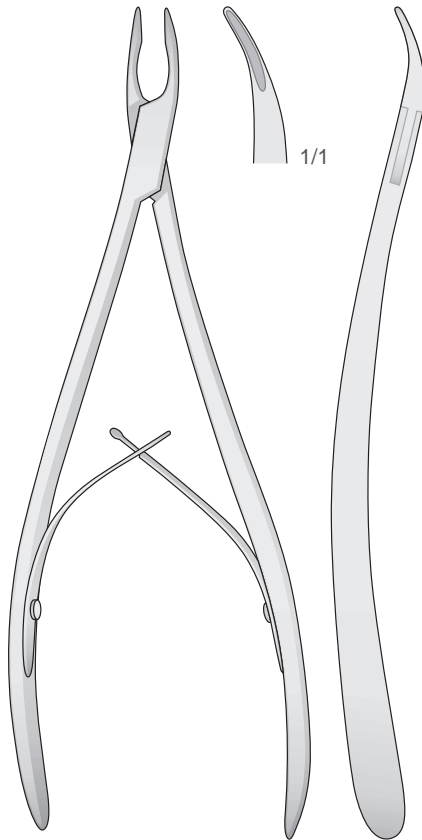

STELLBRINK

58-830-19  
190 mm

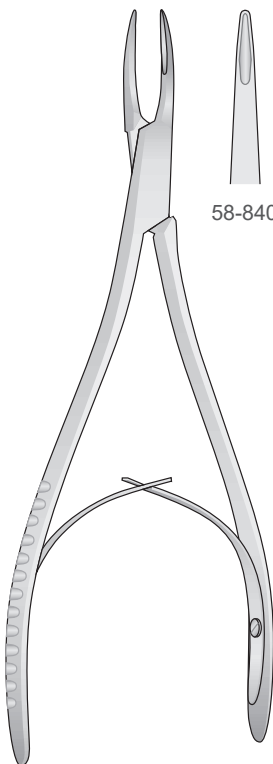

MINI-FRIEDMANN

58-840-15  
150 mm

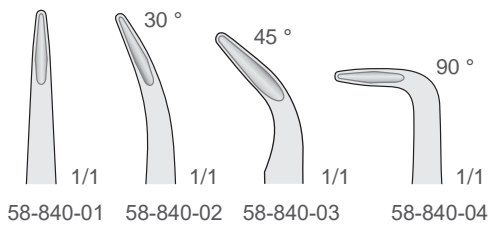

STELLBRINK

58-830-17  
170 mm

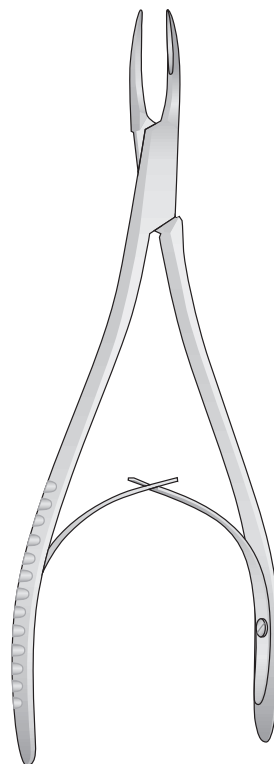

MINI-FRIEDMANN

58-850-14  
145 mm

S-Form

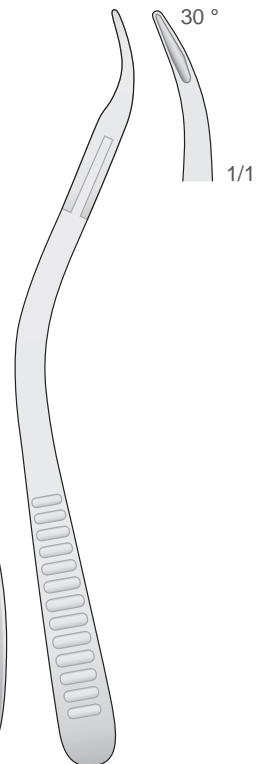

Hohlmeißelzangen  
Bone rongeurs  
Pinze ossivore  
Pinzas gubias  
Pincas gouges

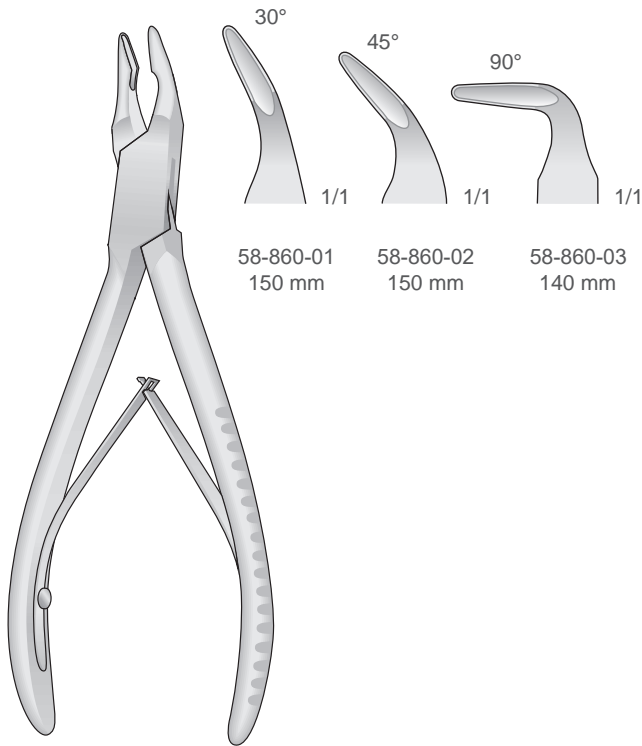

58-860-01  
150 mm

58-860-02  
150 mm

58-860-03  
140 mm

**BLUMENTHAL**  
58-860

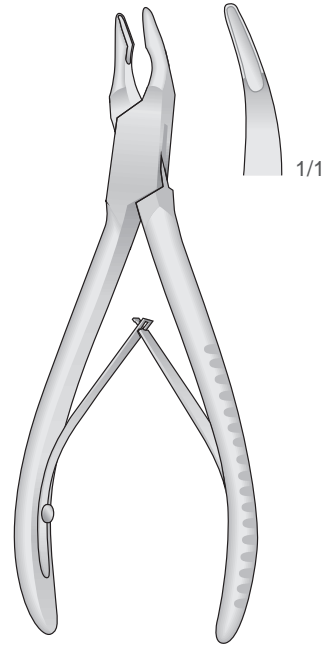

**MINI FRIEDMAN**

58-870-12  
120 mm

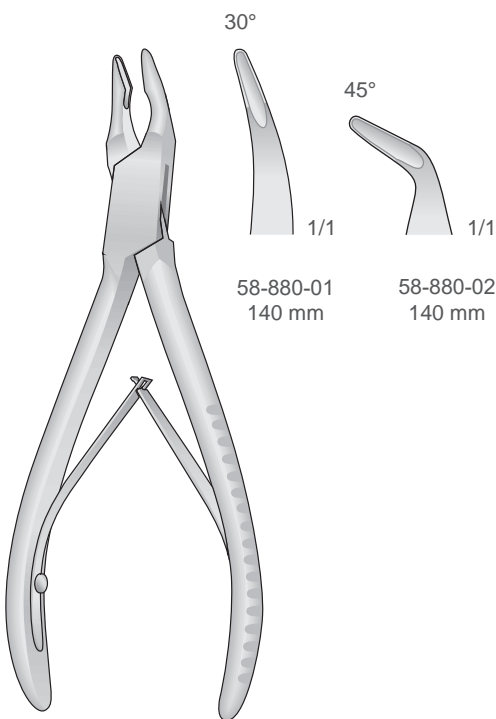

58-880-01  
140 mm

58-880-02  
140 mm

**FRIEDMANN**  
58-880  
140 mm

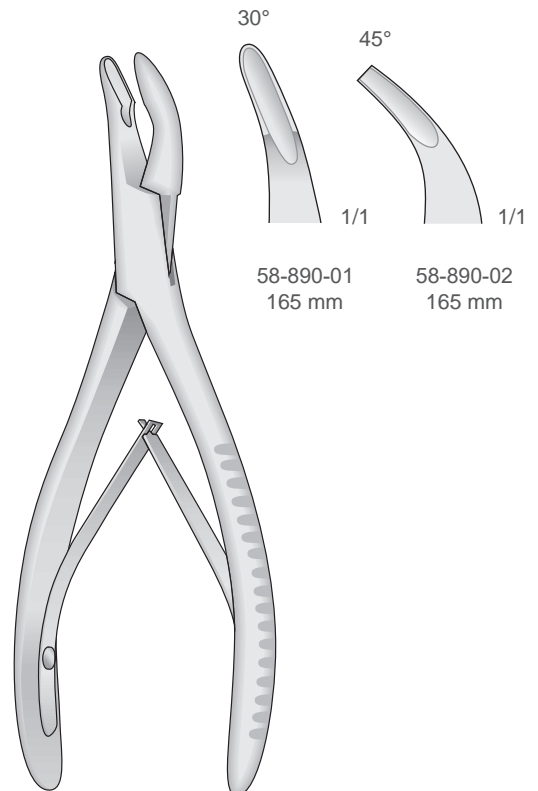

58-890-01  
165 mm

58-890-02  
165 mm

**MEAD**  
58-890  
165 mm

Hohlmeißelzangen  
Bone rongeurs  
Pinze ossivore  
Pinzas gubias  
Pincas gouges

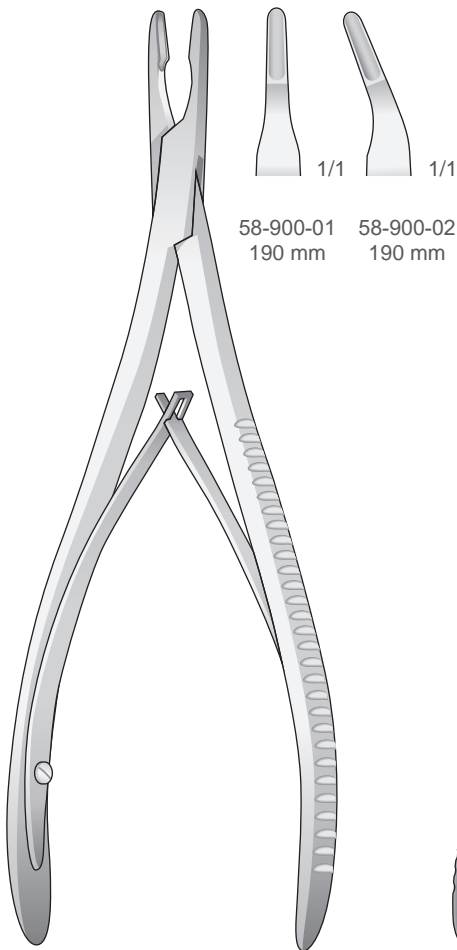

**LEMPERT**  
58-900-19  
190 mm

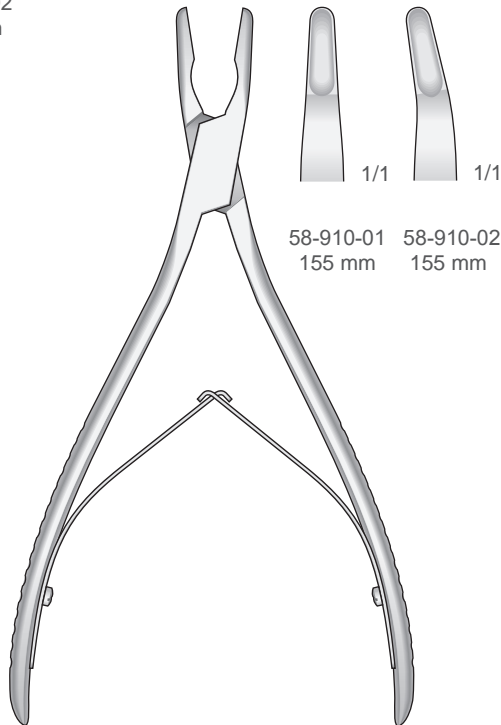

**LEMPERT**  
58-910-15  
155 mm

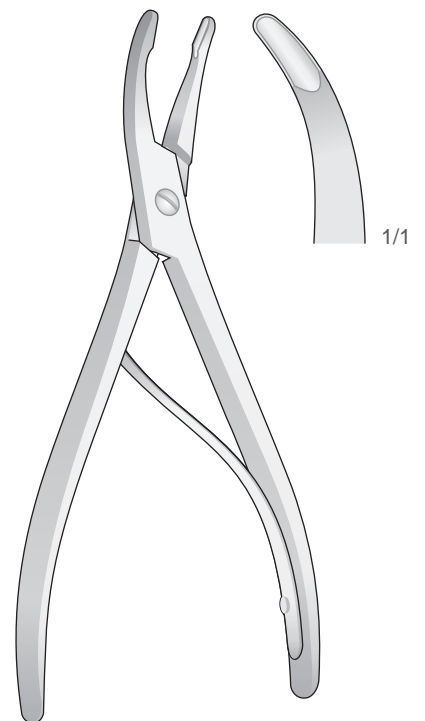

**LUER**  
58-920-15  
155 mm

Hohlmeißelzangen  
Bone rongeurs  
Pinze ossivore  
Pinzas gubias  
Pincas gouges

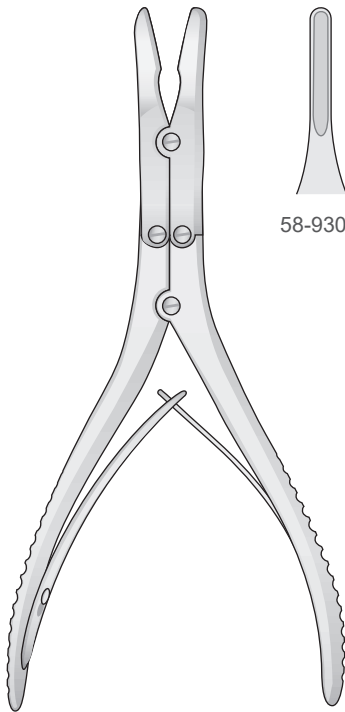

58-930-01 1/1 58-930-02 1/1

**RUSKIN**

58-930-15  
150 mm

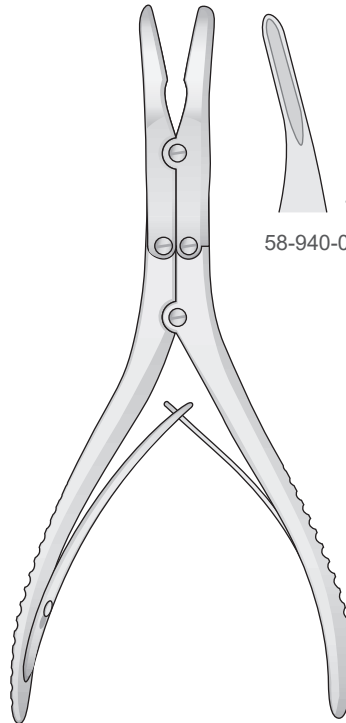

58-940-01 1/1 58-940-02 1/1

**KLEINERT- KUTZ**

58-940-15  
155 mm

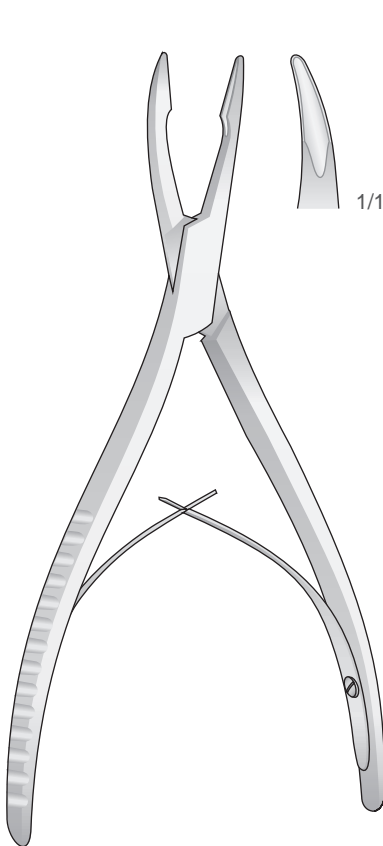

1/1

**FRIEDMANN**

58-950-16  
160 mm

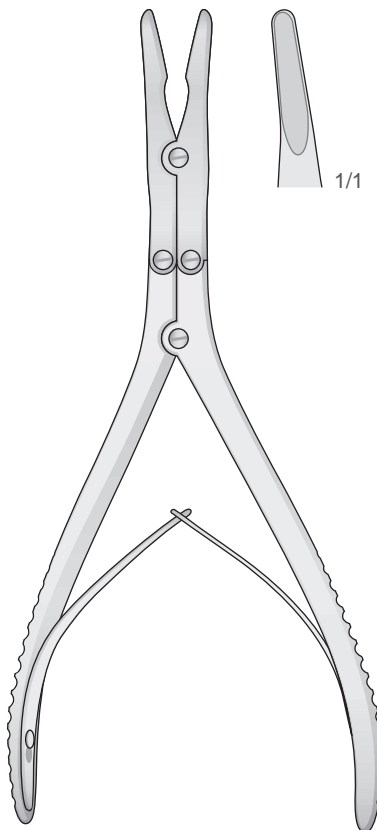

1/1

**BEYER**

58-960-18  
180 mm

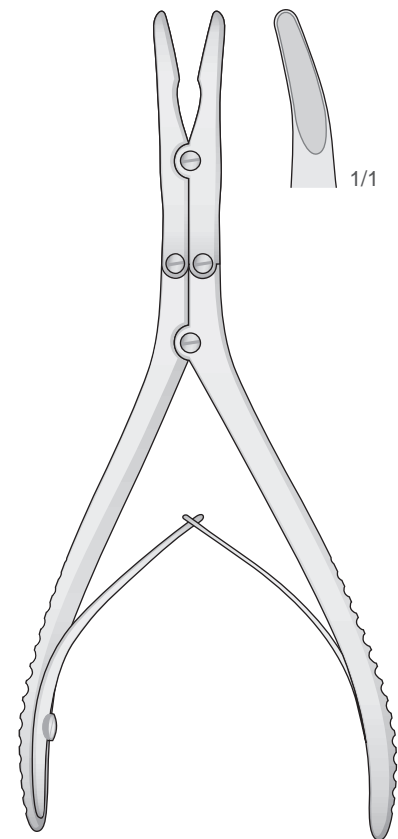

1/1

**ZAUFAL-JANSEN**

58-970-18  
180 mm

Hohlmeißelzangen  
Bone rongeurs  
Pinze ossivore  
Pinzas gubias  
Pincas gorges

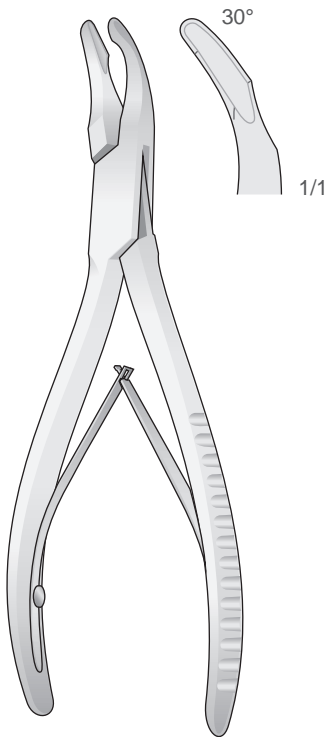

**CLEVELAND**  
58-980-14 140 mm  
58-980-17 170 mm

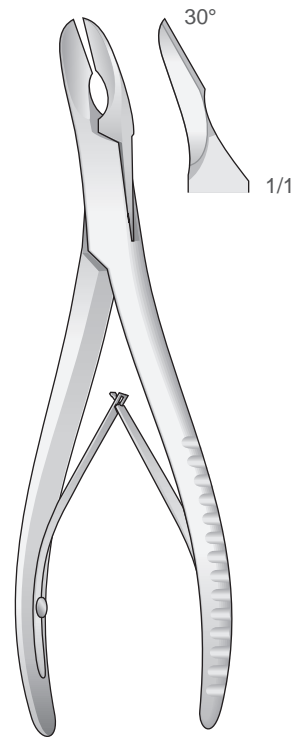

**CLEVELAND**  
58-990-15 150 mm  
58-990-17 170 mm

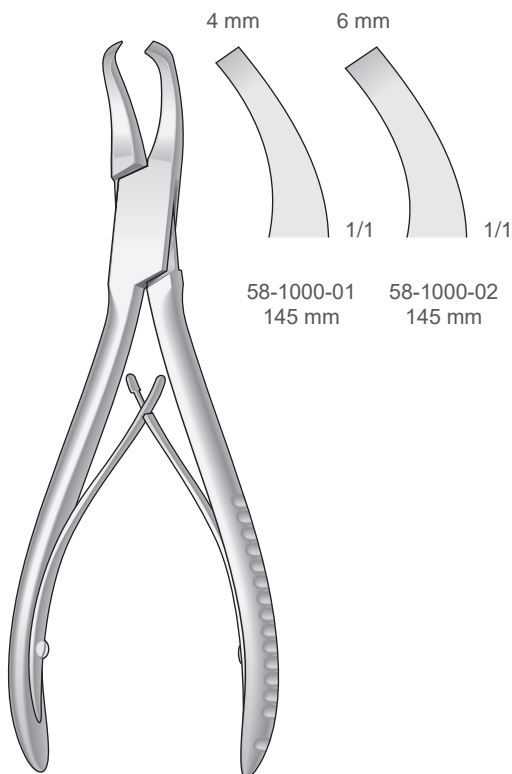

**GARDNER**  
58-1000-01  
145 mm

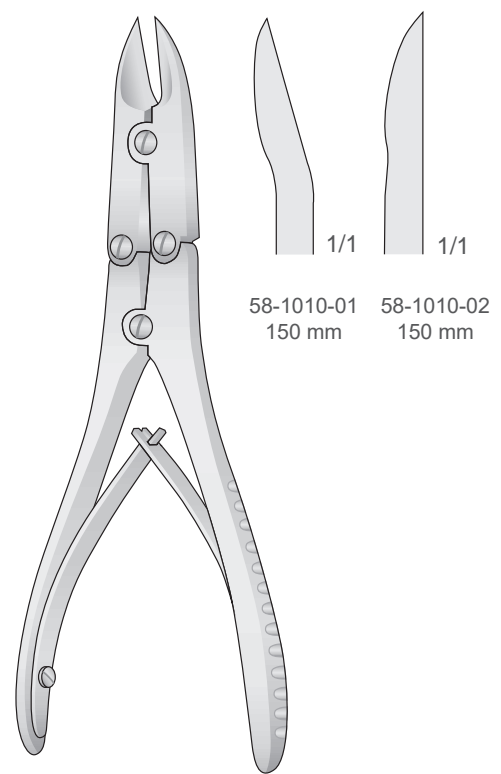

**BÖHLER**  
58-1010-01  
150 mm

Punches - Stanzen

Bone cutting forceps  
for opening the Sinus  
Strumento tagliente per  
aumentare il volume del seno

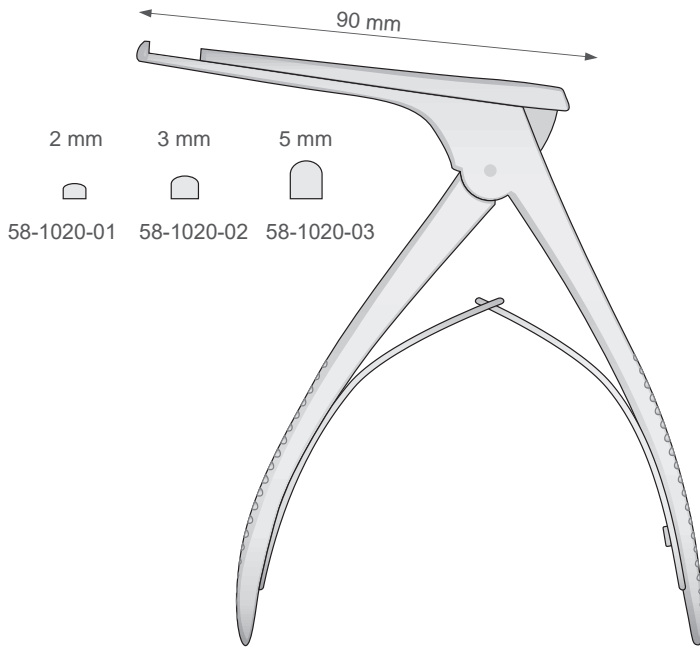

**KERRISON**  
58-1020-01 2 mm  
58-1020-02 3 mm  
58-1020-03 5 mm

Knochensplitterzangen  
Bone cutting forceps  
Pinze ossivore  
Pinzas cortantes para huesos  
Pincas coupantes à os

Bone cutting forceps  
for opening the Sinus  
Strumento tagliente per  
aumentare il volume del seno

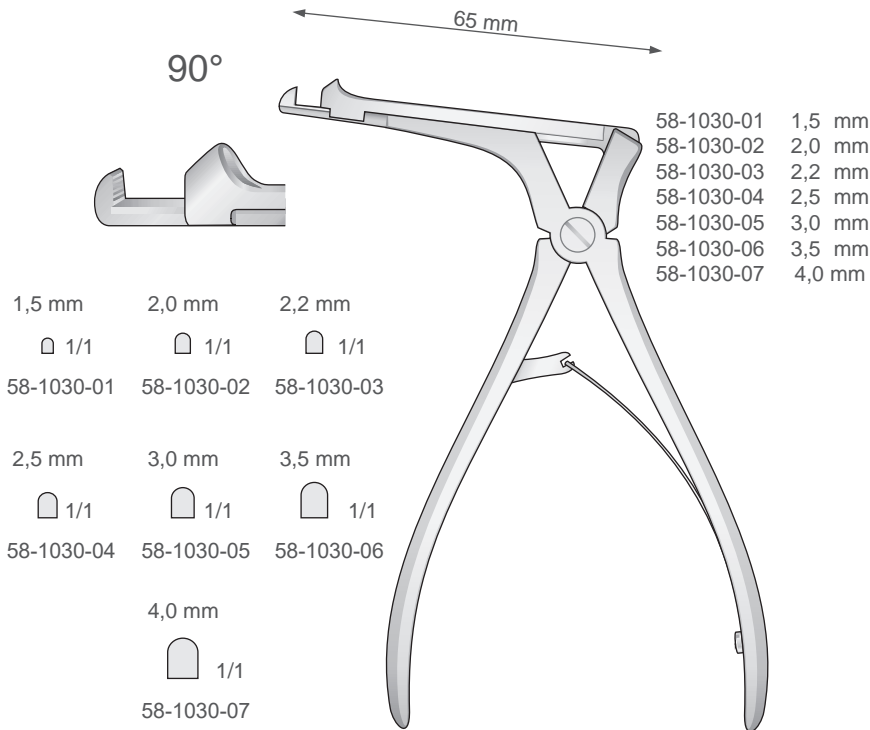

**CITELLI**  
58-1030

Fig.  
R-18

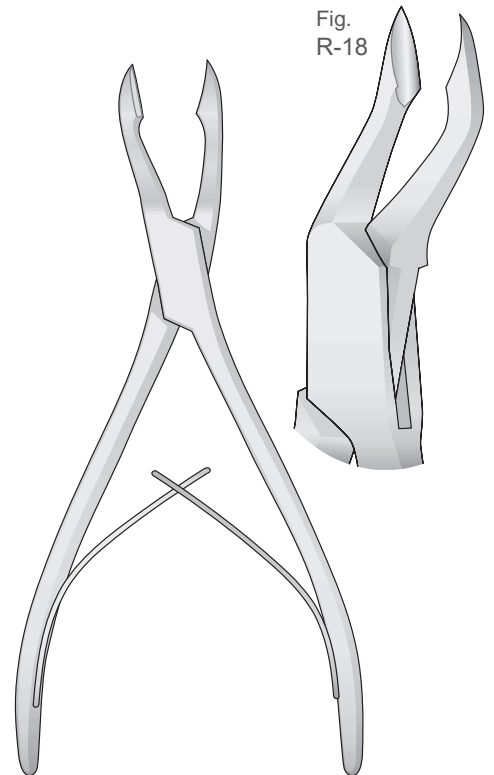

58-1040-17  
175 mm