

PROBES | COTTON APPLICATOR

Sonden | Watteträger

Sondes | Applicateur de coton

Sondas | Porta-algodón

Sonde | Portacotone



Hohlsonde

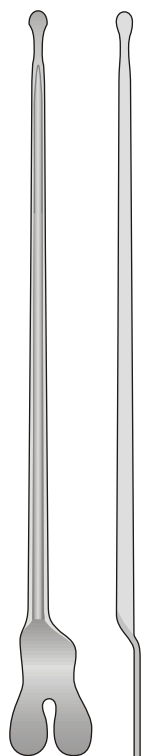

08-100-14 145 mm
08-100-16 160 mm
08-100-18 180 mm
08-100-20 200 mm

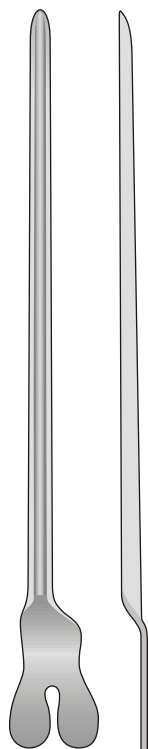

08-110-13 130 mm
08-110-14 145 mm
08-110-16 160 mm
08-110-18 180 mm
08-110-20 200 mm

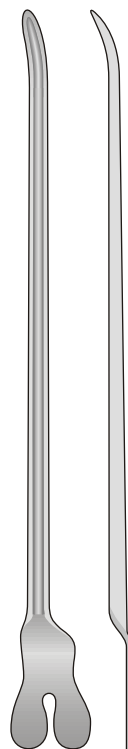

DOYEN
08-120-14
145 mm

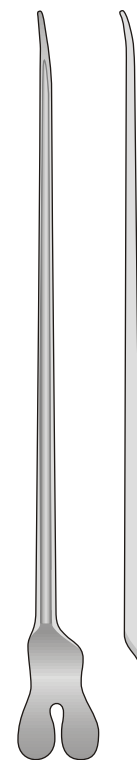

NELATON
08-130-16
160 mm

Sonde per fistole - Fistula probes - Fistelsonden - Sondes pour fistulas - Sondas para fistulas



LOCHART
08-140-01
170 mm



LOCHART
08-140-02
170 mm



LOCHART
08-140-03
170 mm

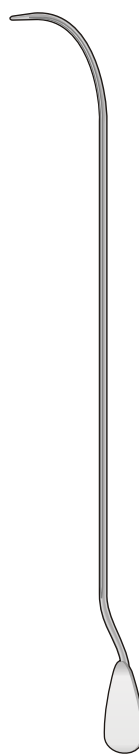

LOCHART
08-140-04
170 mm

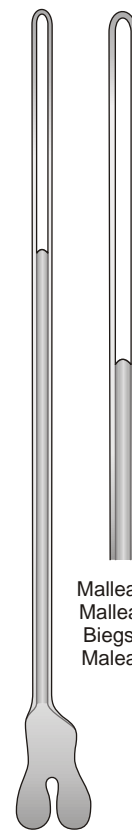

LOCHART
08-150-19
190 mm

1/1

Malleabile
Malleable
Biigsam
Maleable

Ø 1 mm



Ø 1,5 mm



Ø 2 mm



Ø 2 mm



Ø 1,5 mm

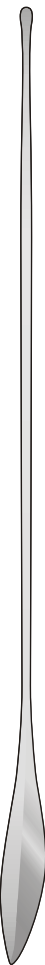

Ø 1,0 mm



08-160-14 145 mm 08-170-13 130 mm 08-180-14 145 mm 08-190-13 130 mm
08-160-16 160 mm 08-170-14 145 mm 08-180-16 160 mm 08-190-14 145 mm
08-170-16 160 mm 08-180-20 200 mm 08-190-16 160 mm
08-170-20 200 mm 08-180-25 250 mm 08-190-20 200 mm

08-200-14
145 mm

STACKE
08-210-11
110 mm

BOWMAN
08-220-01 00/0 08-220-04 5/6
08-220-02 1/2 08-220-05 7/8
08-220-03 3/4 08-220-06 6/7

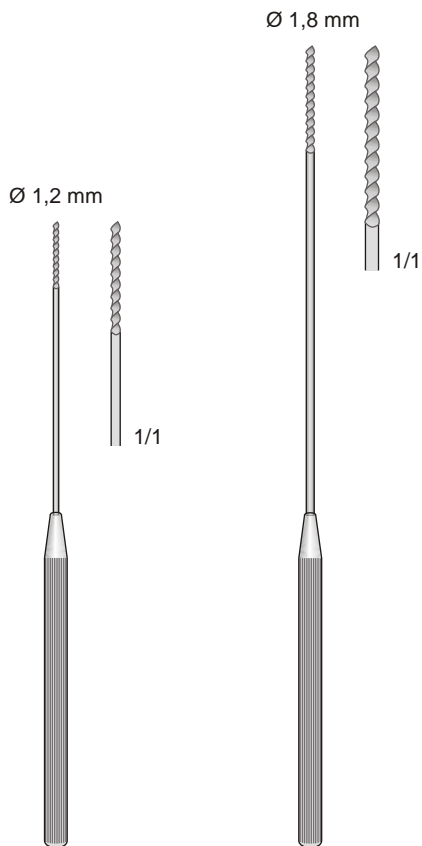

UNIVERSAL
08-230-12 120 mm
08-230-14 140 mm
08-230-16 160 mm

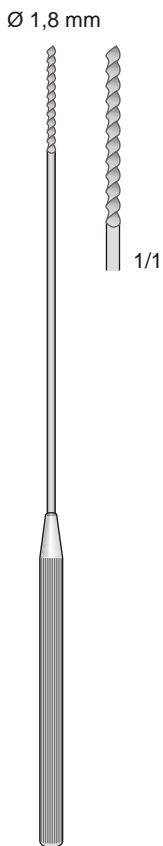

UNIVERSAL
08-240-12 120 mm
08-240-14 140 mm
08-240-16 160 mm
08-240-18 180 mm

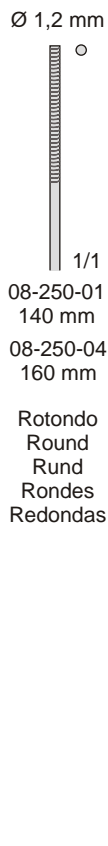

08-250-01 140 mm
08-250-04 160 mm
Rotondo
Round
Rund
Rondes
Redondas



08-250-02 140 mm
08-250-05 160 mm
Triangolare
Triangular
Dreikant
Triangulaires
Triangulares

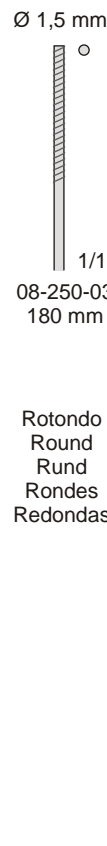

08-250-03 180 mm
Rotondo
Round
Rund
Rondes
Redondas

MOD. MARTIN
08-250

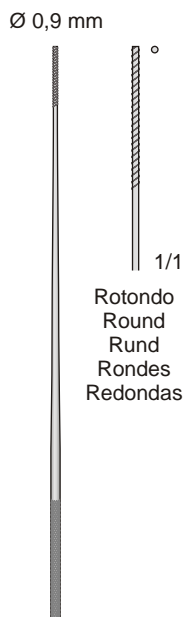

FARRELL
08-260-01 120 mm

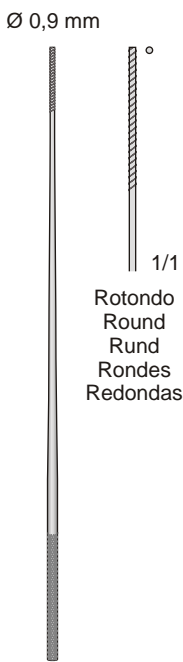

FARRELL
08-260-02 140 mm
08-260-03 160 mm
08-260-04 180 mm

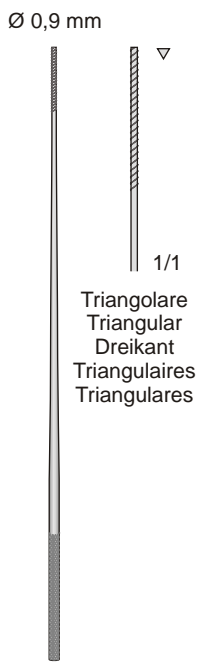

FARRELL
08-260-05 140 mm
08-260-06 160 mm

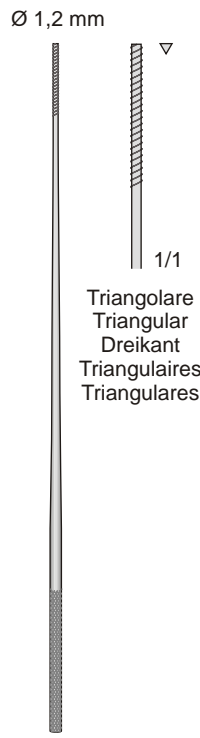

FARRELL
08-260-07 180 mm

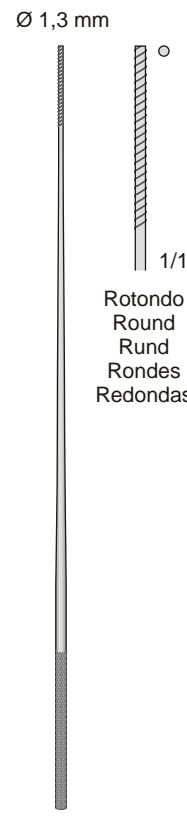

FARRELL
08-260-08 230 mm

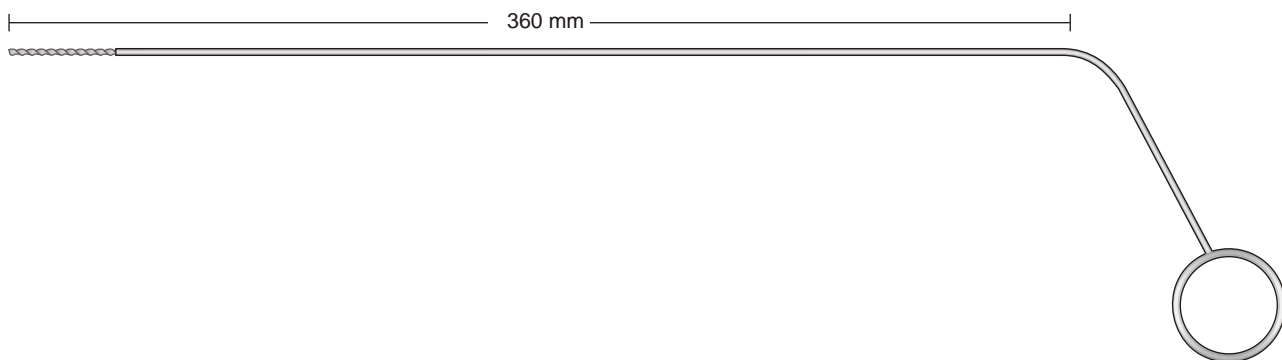

08-270-40
400 mm

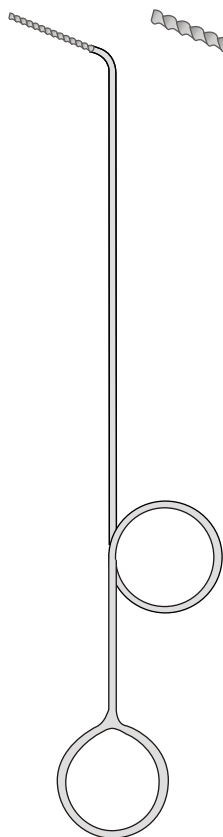

HARTMANN
08-280-22 - Ø 2,3 mm
220 mm

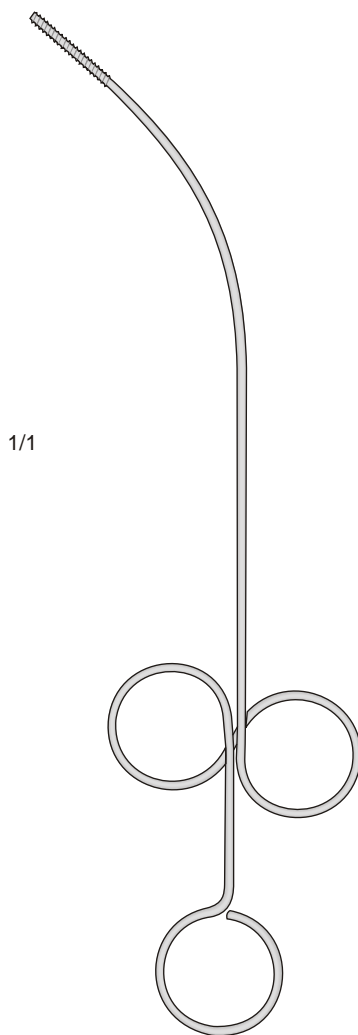

FEIN
08-290-25
250 mm

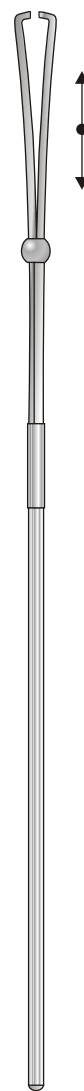

HEILDEBERG
08-300-18
180 mm



HEILDEBERG
08-310-17
170 mm



