

62

ORTHODONDLICS



 **Wrangler**
Instruments

www.wrangler.pk

Gefäße aus Edelstahl
Stainless Steel Receptacles
Recipienti in acciaio inossidabile
Recipientes de acero inoxidable
Réceptacles en acier inoxydable

Nadeldose
Needle case
Scatola per aghi
Caja para agujas
Boîte à aiguilles



62-100
Ø 78 mm h 15 mm

Verbandstofftrommeln
Dressing sterilizing drums
Cestelli cilindrici
Caja para esterilización
Boîte à stérilisation

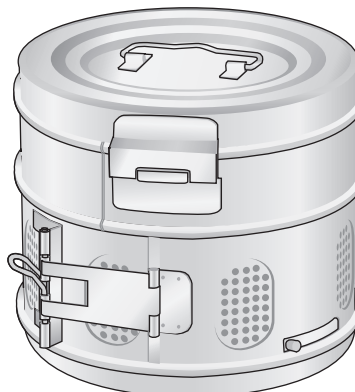

62-110-01 125x125 mm
62-110-02 150x150 mm
62-110-03 190x145 mm

Nierenschalen
Kidney bowls
Bacinelle reniformi
Riñoneras
Bassins réniformes

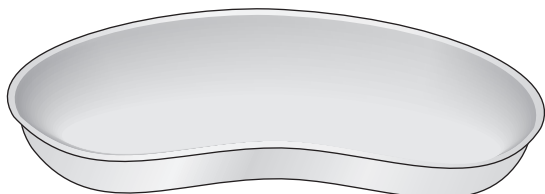

62-130-01 200 mm
62-130-02 250 mm
62-130-03 280 mm

Runder Sterilbehälter mit Ausguss
Round sterile bowl
Capsule inox con fondo piano e becco
Cubetas de acero inoxidable
Cuvettes de acier inoxydable

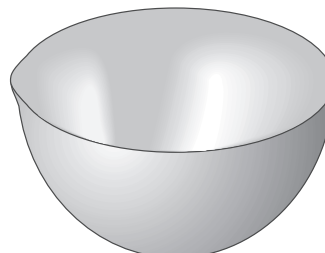

62-140-01 Ø 40 mm 15 cc
62-140-02 Ø 60 mm 75 cc
62-140-03 Ø 80 mm 225 cc
62-140-04 Ø 100 mm 325 cc
62-140-05 Ø 120 mm 500 cc



62-150-00
180 x 85 x 20 mm

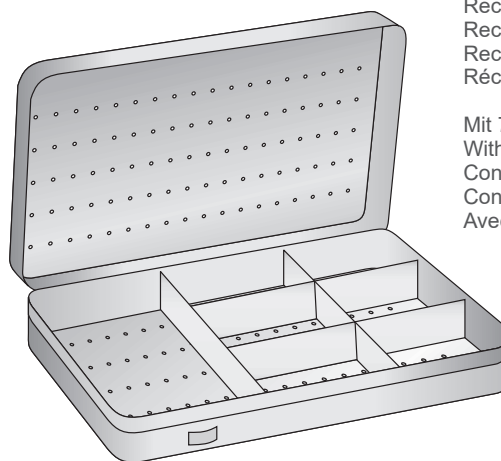

62-160-00
150 x 90 x 20 mm

Gefäße
Receptacles
Recipiente
Recipientes
Réceptacles

Mit 7 box
With 7 box
Con 7 box
Con 7 box
Avec 7 box

Schalen
Trays
Vassoi
Bandejas
Bassins

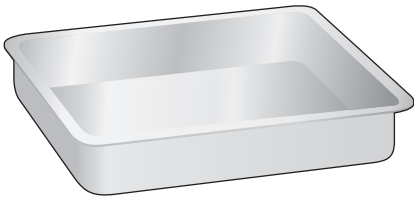

62-170-01 210 x 110 x 25 mm
62-170-02 250 x 180 x 30 mm
62-170-03 300 x 220 x 30 mm

Steril Container
Sterilization Container
Contenitori per sterilizzazione
Contenedores para esterilización
Conteneurs pour stérilisation

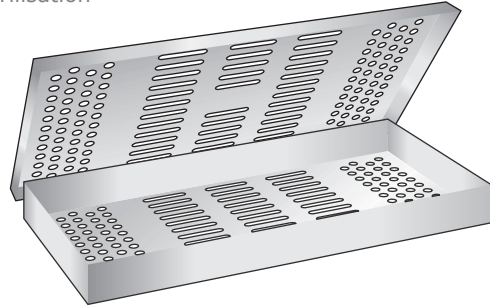

62-180-27
275 x 130 x 25 mm

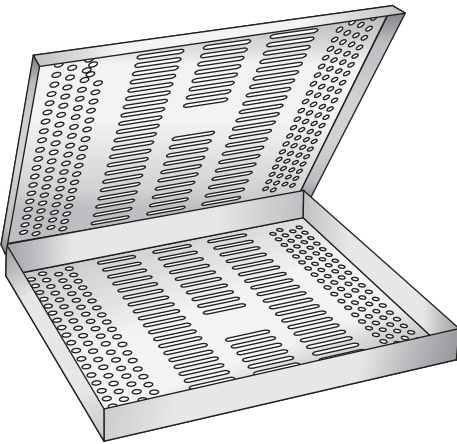

62-190-28
285 x 190 x 25 mm

Mit Instrumentehalter und box
With Insert frames and box
Con griglia e scomparti
Con porta instrumentos y box
Avec Porte instruments et box

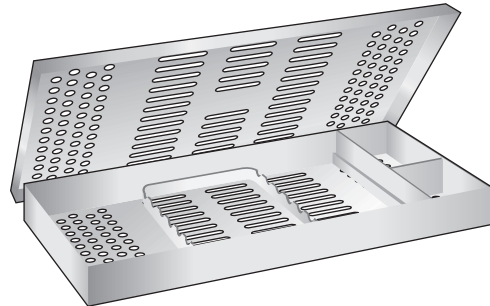

62-200-01 275x130x25mm
62-200-02 285x190x25mm

Silicon Mat
Silikon Noppenmatten
Tappeti di silicone
Tapiz de silicona
Tapis en silicone

Autoklav
Autoclavable
Autoclavabile
Autoclave
Autoclave

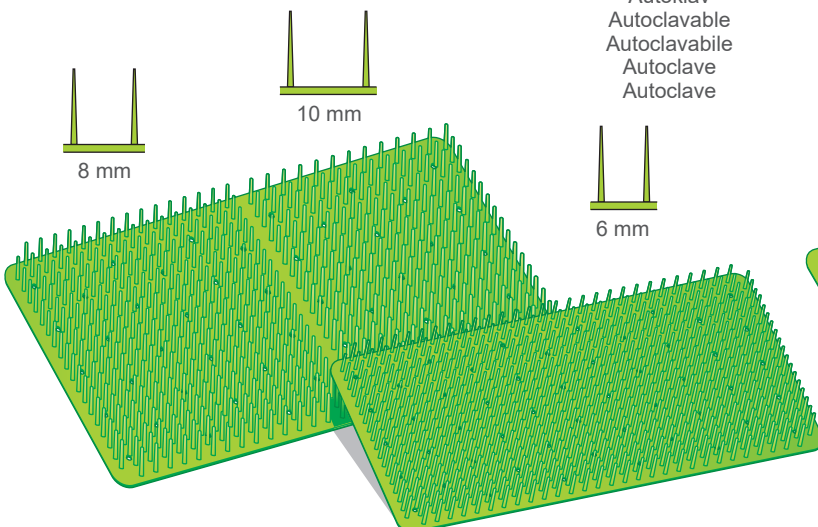

62-210-01
270 x 180 mm

62-210-02
260 x 120 mm

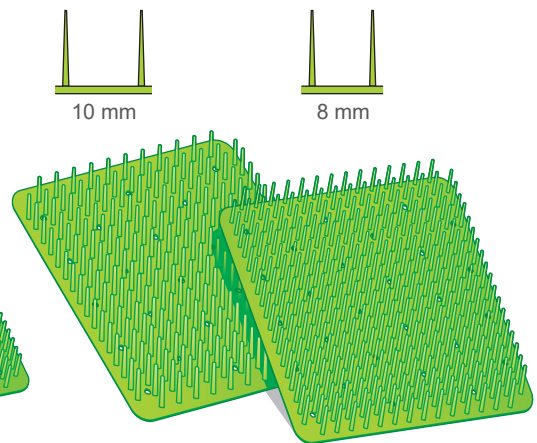

62-220-01
135 x 180 mm

62-220-02
135 x 180 mm

Steril Container
Sterilization Container
Contenitori per sterilizzazione
Contenedores para esterilización
Conteneurs pour stérilisation

Rostfreier Stahl Sterilcontainer mit Silikoneinrichtung
Stainless Steel Sterilization Containers with silicone racks
Contenitori per sterilizzazione in acciaio inossidabile con griglia in silicone
Contenedores para esterilización en acero inoxidable con soportes en silicona
Containers pour stérilisation en acier inoxydable avec des supports de silicone

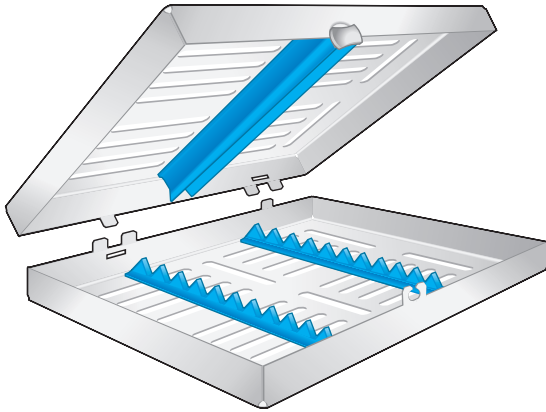

62-230-01
185 x 135 x 35 mm
For 10 Instruments

62-230-02
290 x 185 x 35 mm
For 20 Instruments

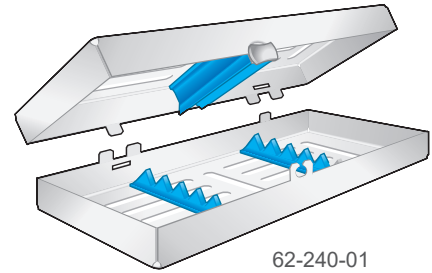

62-240-01
185 x 75 x 35 mm
For 5 Instruments

62-250-01
62-250-02
62-250-03



62-260-01
62-260-02
62-260-03



Sterilcontainer,
mit Deckel- und Bodenperforation,
passend in gängige Praxisautoklaven
Containers for sterilization,
with perforation in lid and bottom,
suitable for common practice autoclaves
Contenitori dentali,
con coperchio e fondo perforato,
adatti a tutte le autoclavi comuni
Contenedores dentales,
con tapa y fondo perforados,
aptos para autoclaves habituales
Containers stérile,
avec perforation du couvercle et du fond,
convenant aux autoclaves courants

Silikoneinrichtung für Tray
Silicone Racks for Tray
Griglia in Silicone per Tray
Equipo de silicona para Tray
Aménagement en silicone pour Tary



62-250-0
300 x 140 x 40 mm
62-260-01
310 x 190 x 40 mm

62-250-02
300 x 140 x 70 mm
62-260-02
310 x 190 x 65 mm

62-250-03
300 x 140 x 100 mm
62-260-03
310 x 190 x 130 mm

Alu
Aluminium
Alluminio
Aluminio
Aluminum

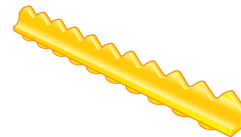

TRANSLUCENT YELLOW
62-270-01
130 mm

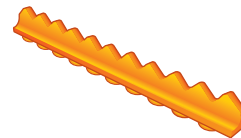

ORANGE
62-270-02
130 mm

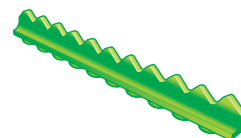

TRANSLUCENT GREEN
62-270-03
130 mm

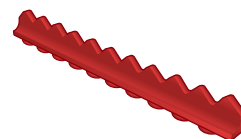

RUST RED
62-270-04
130 mm

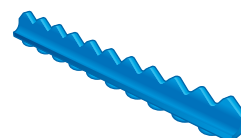

BLUE
62-270-05
130 mm

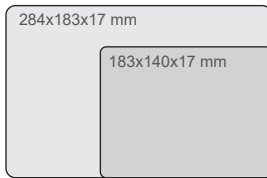

Farbcodiert-Tray-Unterteile für 17 instrumente
Color-Coded bases for 17 instruments
Vassoio colorati per 17 strumenti
Bandejas en colores para 17 instrumentos
Plateaux colorés pour 17 instruments

Für 17 instrumente
For 17 instruments
Per 17 strumenti
Para 17 instrumentos
Pour 17 instruments

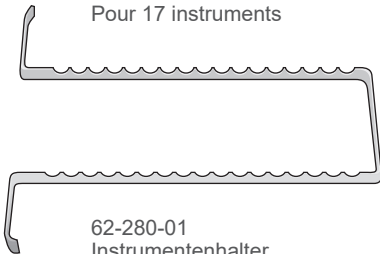

62-280-01
Instrumentenhalter
Insert frames Griglia
Portastrumenti Porta
instrumentos Porte
instruments

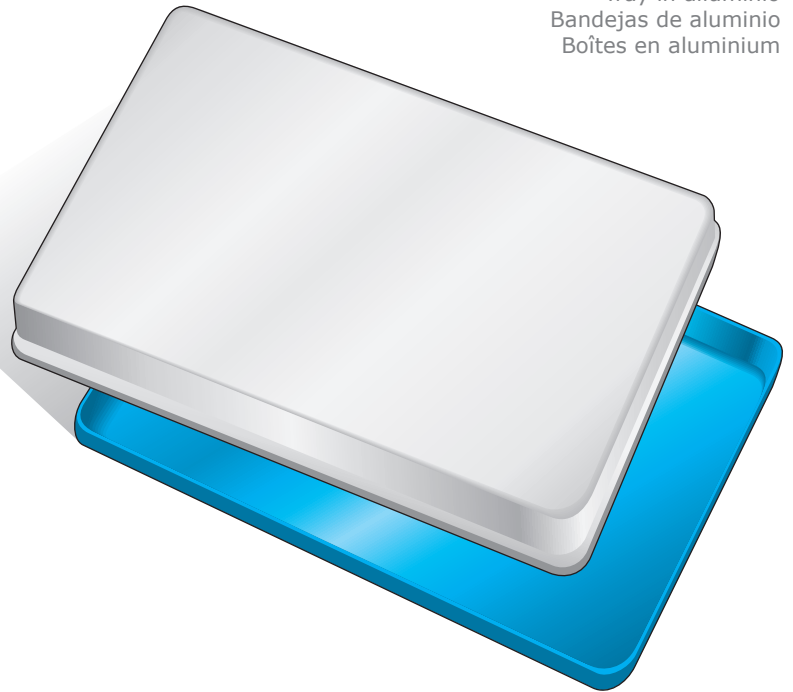

Aluminium-Tray
Aluminium Trays
Tray in alluminio
Bandejas de aluminio
Boîtes en aluminium



62-280-02
284x183x17 mm
Unterteile allein
Only base
Vassoio solo
Bandeja suelta
Plateau seul

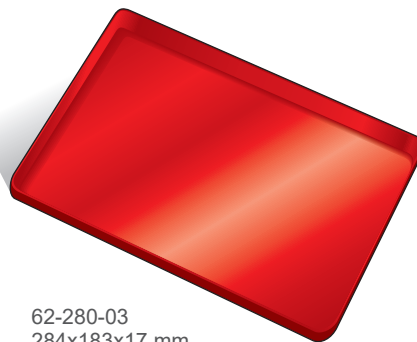

62-280-03
284x183x17 mm
Unterteile allein
Only base
Vassoio solo
Bandeja suelta
Plateau seul

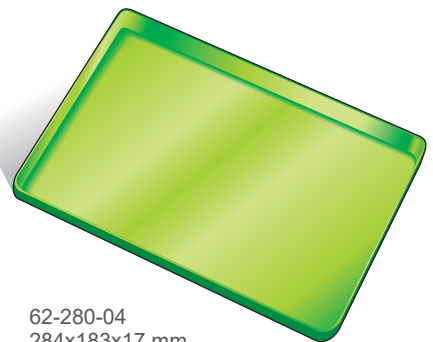

62-280-04
284x183x17 mm
Unterteile allein
Only base
Vassoio solo
Bandeja suelta
Plateau seul

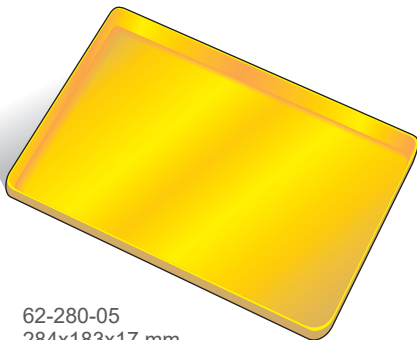

62-280-05
284x183x17 mm
Unterteile allein
Only base
Vassoio solo
Bandeja suelta
Plateau seul

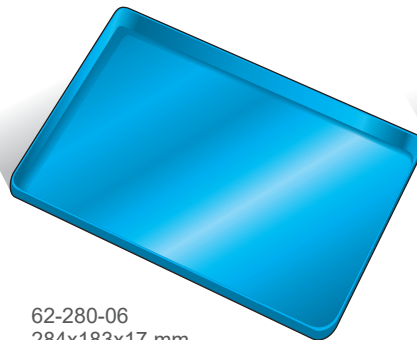

62-280-06
284x183x17 mm
Unterteile allein
Only base
Vassoio solo
Bandeja suelta
Plateau seul



62-280-07
288x187x29 mm
Tray-Deckel, grau
Lid - Grey only
Coperchio - Solo argento
Tapa en color gris
Couvercle - seulement en gris

Aluminium MIDI Tray
Aluminium MIDI Trays
Tray in alluminio, misura MIDI
Bandejas de aluminio, tamaño MIDI
Boîtes en aluminium, format MIDI

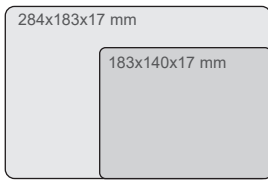

Farbcodiert-Tray-Unterteile für 8 instrumente
Color-Coded bases for 8 instruments
Vassoi colorati per 8 strumenti
Bandejas en colores para 8 instrumentos
Plateaux colorés pour 8 instruments

Für 8 instrumente
For 8 instruments
Per 8 strumenti
Para 8 instrumentos
Pour 8 instruments

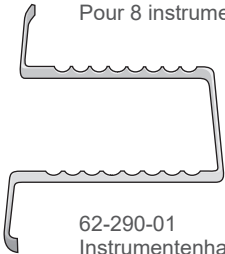

62-290-01
Instrumentenhalter
Insert frames Griglia
Portastrumenti Porta
instrumentos Porte
instruments



62-290-02
183x140x17 mm
Unterteile allein
Only base
Vassoio solo
Bandeja suelta
Plateau seul

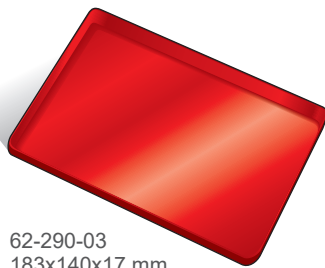

62-290-03
183x140x17 mm
Unterteile allein
Only base
Vassoio solo
Bandeja suelta
Plateau seul

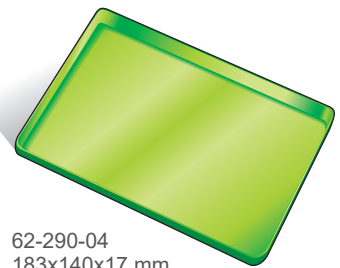

62-290-04
183x140x17 mm
Unterteile allein
Only base
Vassoio solo
Bandeja suelta
Plateau seul

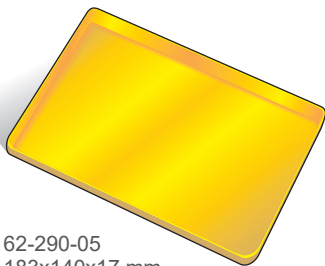

62-290-05
183x140x17 mm
Unterteile allein
Only base
Vassoio solo
Bandeja suelta
Plateau seul

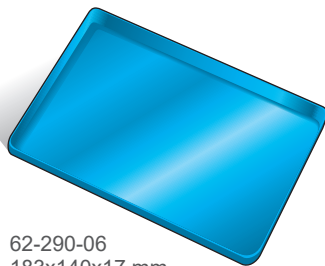

62-290-06
183x140x17 mm
Unterteile allein
Only base
Vassoio solo
Bandeja suelta
Plateau seul



62-290-07
187x145x25 mm
Tray-Deckel, grau
Lid - Grey only
Coperchio - Solo argento
Tapa en color gris Couvercle
- seulement en gris

Steril Container
Sterilization Container
Contenitori per sterilizzazione
Contenedores para esterilización
Conteneurs pour stérilisation

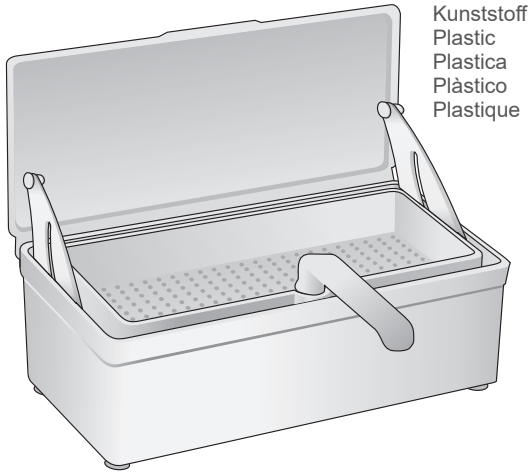

Kunststoff
Plastic
Plastica
Plástico
Plastique

62-300-25
255 x 105 x 85 mm

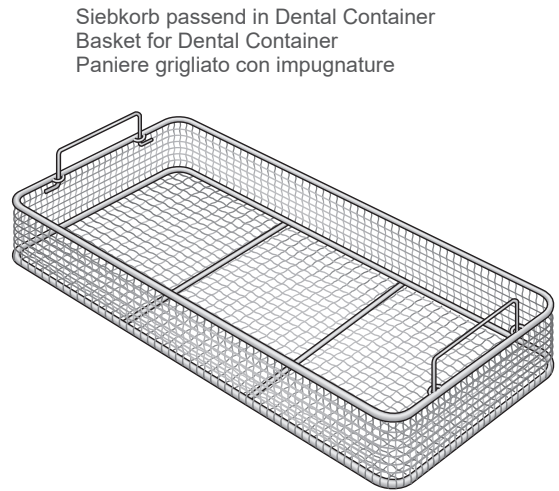

Siebkorb passend in Dental Container
Basket for Dental Container
Paniere grigliato con impugnature

62-310-26
265 x 120 x 45 mm

Rostfrei - Stainless steel - Inox - Inoxidable - Inoxydable

Norm-tray complet mit tray-unterteile, deckel und instrumentenhalter für 23 instrumente
Instrument tray complete with base, lid and insert frame for 23 instruments
Portastrumenti completo di vassoio, coperchio e griglia per 23 strumenti
Bandeja completa de tapa y porta instrumentos para 23 instrumentos
Boite complete avec plateau et couvercle pour 23 instrumentes

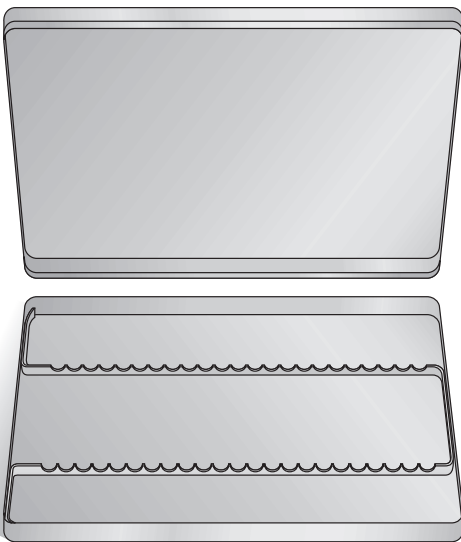

TRAY INOX
62-320-28
284 x 183 x 17 mm

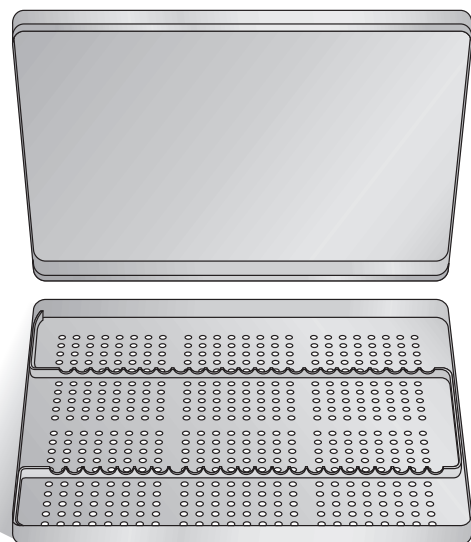



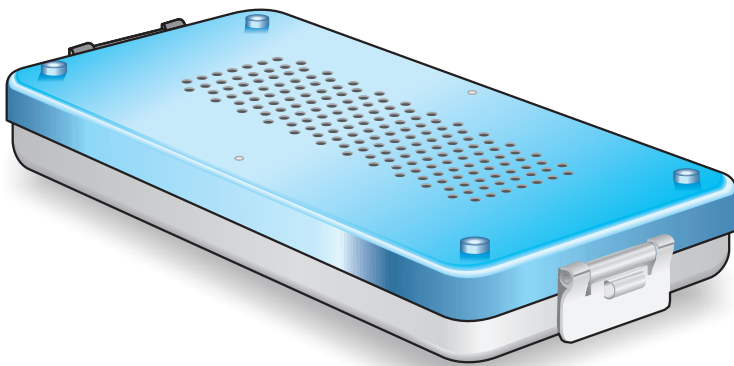

TRAY INOX
62-330-28
284 x 183 x 17 mm

Steril Container
Sterilization Container
Contentori per sterilizzazione
Contenedores para esterilización
Conteneurs pour stérilisation



Small



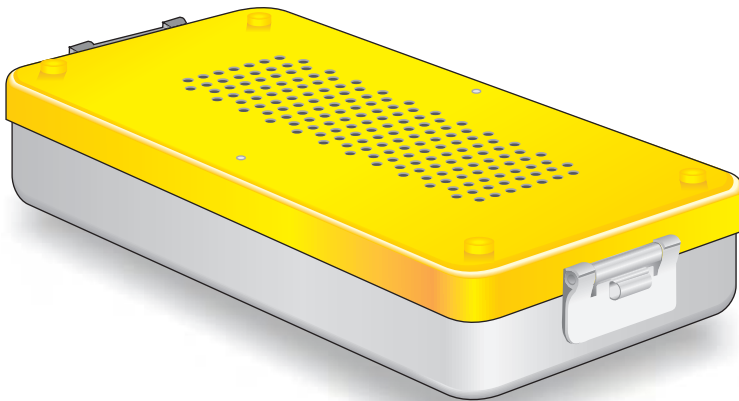

outside: 300 x 140 x 40 mm
inside: 280 x 130 x 27 mm

-  62-340-01
-  62-340-02
-  62-340-03
-  62-340-04
-  62-340-05



Medium



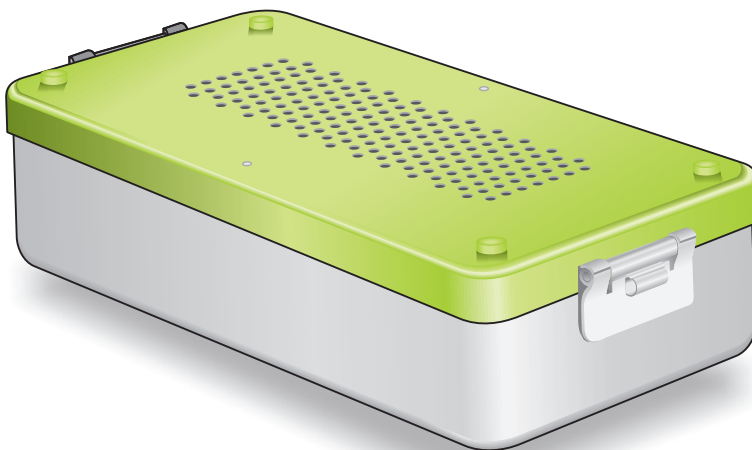

outside: 300 x 140 x 70 mm
inside: 280 x 130 x 55 mm

-  62-350-01
-  62-350-02
-  62-350-03
-  62-350-04
-  62-350-05



Large

outside: 300 x 140 x 100 mm
inside: 280 x 130 x 84 mm

-  62-360-01
-  62-360-02
-  62-360-03
-  62-360-04
-  62-360-05

Original Arkansas

Sharpening Stones
Schleifsteine
Pierres à aiguiser
Piedras de afilar
Pietre per affilare

DB-4
ARKANSAS # 4
100 mm

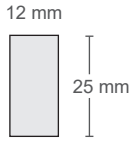

DB-299
ARKANSAS
conica # 299
90 mm



DB-96
ARKANSAS # 8
100 x 50 x 13 mm



Instrumentenpflege
Maintenance of instruments
Mantenimento dello strumentario
Mantenimiento del instrumental
Nettoyage d'instruments

Teflon Stick for sharpening test
Teflon-Stäbchen für das Schärfe-Test
Bastón de teflon para probar afilado
Bâton en teflon pour tester l'aiguillage
Bastoncino di Teflon per provare affilatura

DB-15
100 mm



DB-6A
ARKANSAS # 6A
100 mm

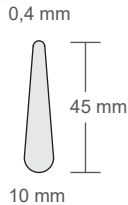

10 mm



DB-11
155 mm

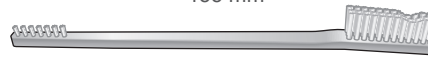

DB-12
175 mm

Brushes for instruments
Instrumente-Reinigungsbürsten
Brosses pour instruments
Cepillos para instrumentos
Spazzolino per strumenti



DB-3
INDIA # 6
100 mm

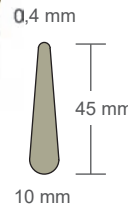

10 mm

Lubricating and sharpening oil
SHARPENOIL

It is a non-coloured oil, which is an indispensable complement for lubricating and manual sharpening of surgical instruments. It should be applied to ensure perfect function and fluid movement of all surgical instruments (on all hinges or all other part which are subject to movement or friction).

Must always be used during all sharpening operations. It is used to activate the abrasive properties of all stones (Arkansas, India, etc.), and to reduce the possibility of overheating the instruments during sharpening.



DB-OL
SCHARPENÖL
30 cc

Special Rubber for Metal
Spezial-Gummi für Metall
Caoutchouc spécial pour métal
Goma especial para metal
Gomme speciali per metalli

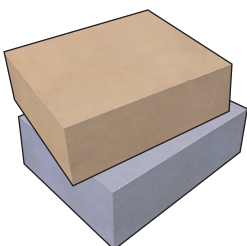

DB-07 / DB-08
Fine / Coarse
50 x 40 x 20 mm

Bacteriostatic Anti-Corrosion Milk
CLEANLACT

Extends your surgical instrument's lifetime. A periodic use of Cleanlact prevents corrosion; it has a bacteriostatic and lubricating action on all instruments; it guarantees perfect maintenance by eliminating eventual stains, halos and browning due to sterilization, disinfection and washing with tap water. Must use periodically, diluted or concentrated (see special instructions on packaging).



CLEANLACT
DB-10M
250 cc
DB-50M
500 cc
DB-1L
1000 cc

Vorbereitung - Nagel scheren
Preparation - Nail scissors
Preparazione - Forbici per unghie
Preparación - Tijeras para uñas
Préparation - Ciseaux à ongles

Handwaschbürste
Nail brushes
Spazzola per unghie
Cepillo para uñas
Brosse à ongles



62-370-01
4 x 11 cm

Autoclavable

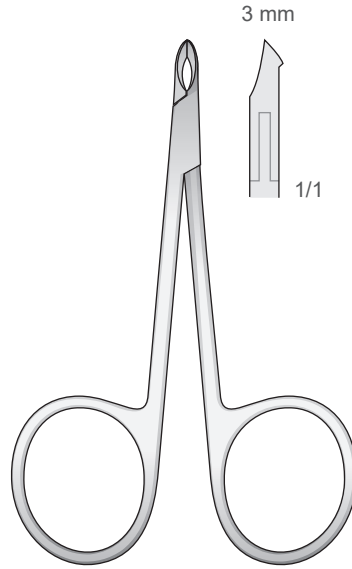

62-380-08
85 mm

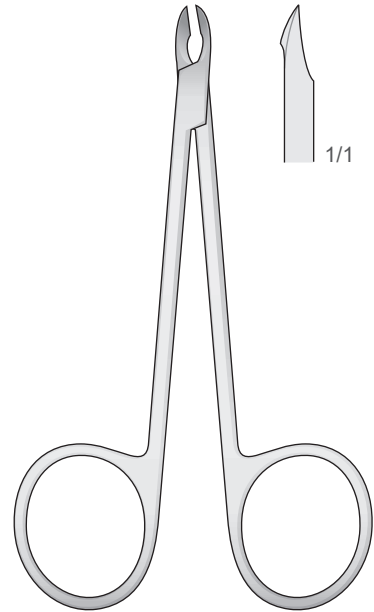

62-390-10
100 mm

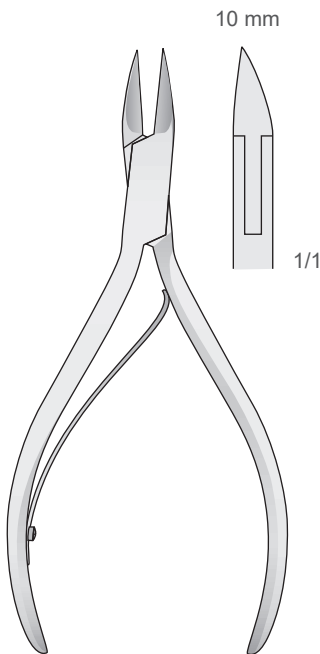

62-400-10
100 mm

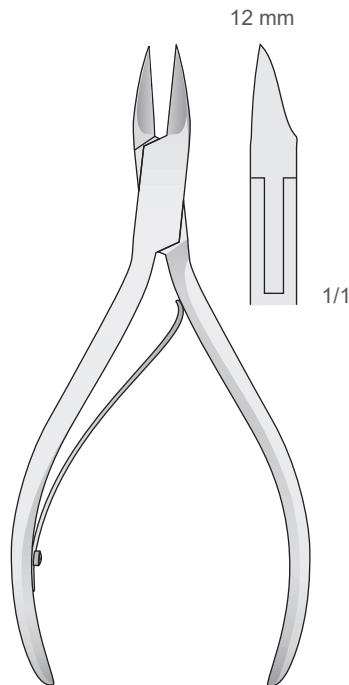

62-410-11
110 mm

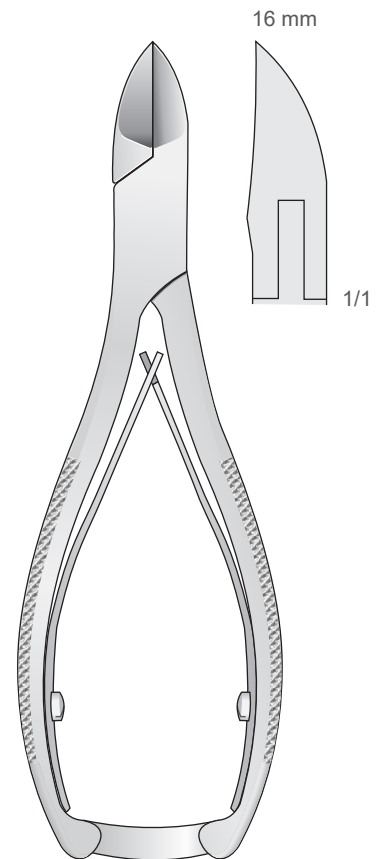

62-420-14
140 mm

Sterilisierzangen
Sterilizing Forceps
Pinze per sterilizzazione
Pinzas para esterilización
Pinces pour stérilisation



62-430-14
145 mm

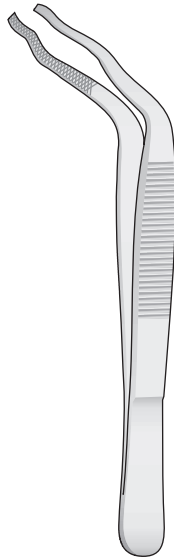

DAVIS
62-440-16
160 mm

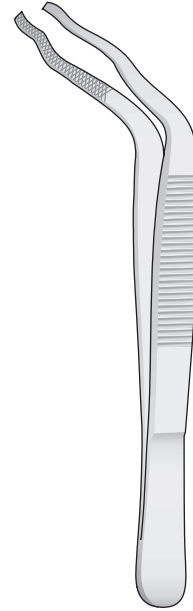

DAVIS
62-450-20
200 mm

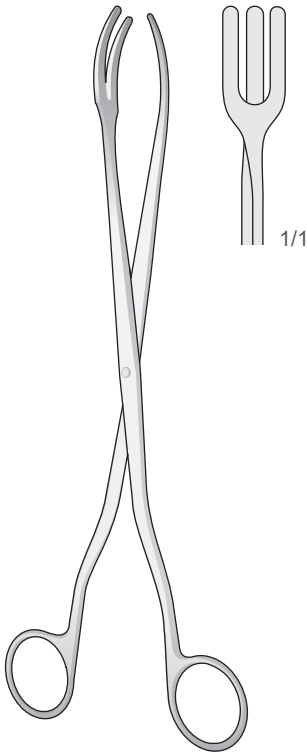

62-460-20
200 mm

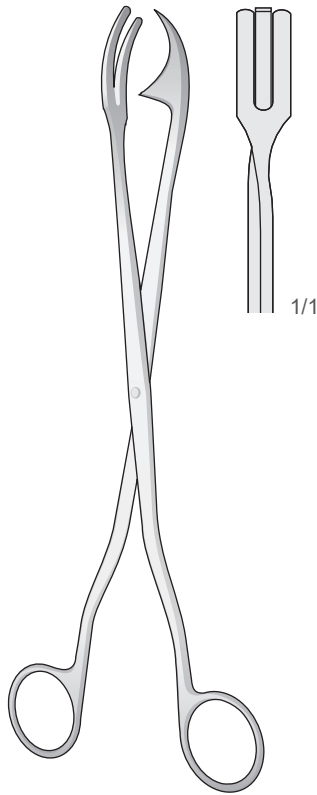

ROGGE
62-470-23
230 mm

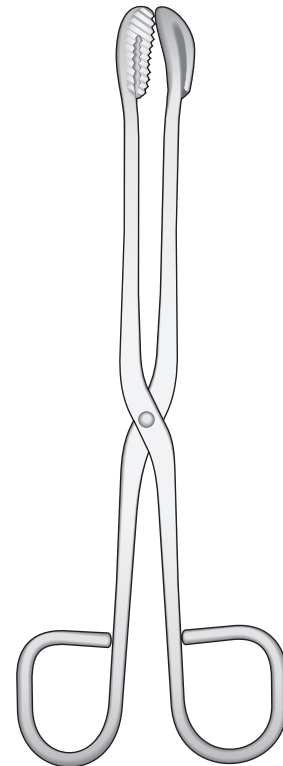

62-480-20
200 mm



**Wrangler
Instruments**

Factory Location:
4 -KM Daska Road Sialkot 51310 Pakistan

Tel: +92 52 352 52 78

Fax: +92 52 352 52 77

E-mail: info@wrangler.pk

Web: www.wrangler.pk

