

**OPHTHALMOLOGY**

Ophthalmologie

Ophtalmologie

Oftalmología

Oftalmologia

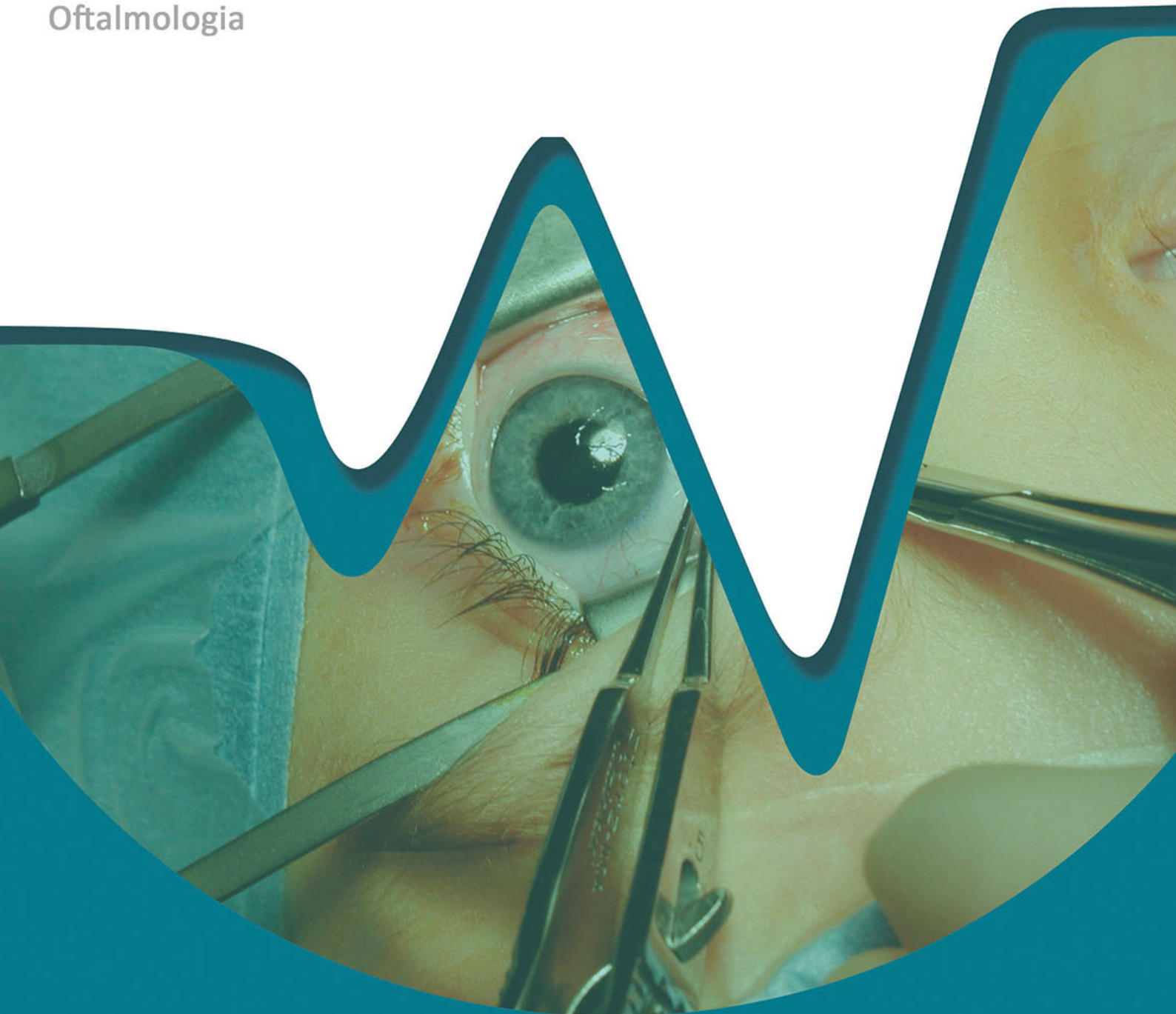

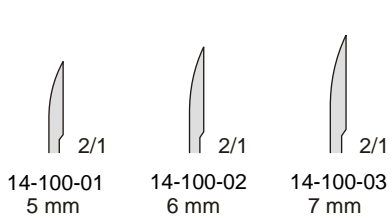

**ZIEGLER**  
14-100  
115 mm

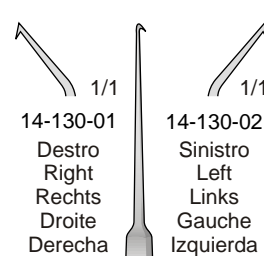
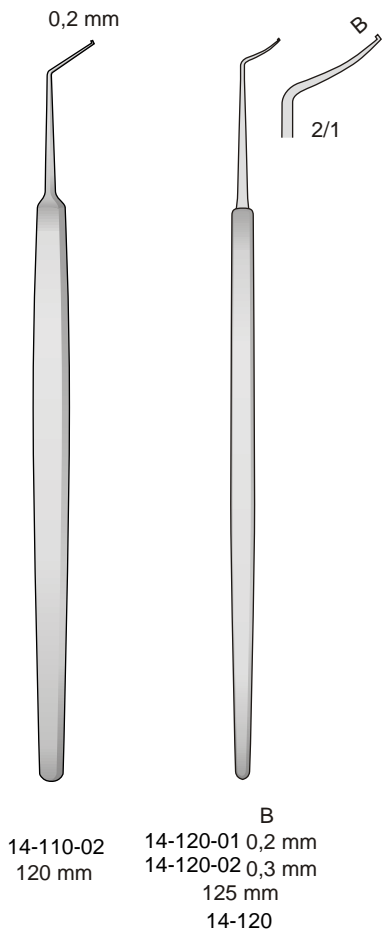

**GRAEFE**  
14-130  
130 mm

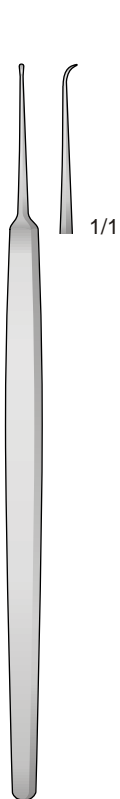

**LA FORCE**  
14-140-12  
120 mm

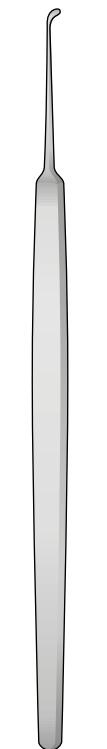

**ELLIS**  
14-150-12  
120 mm

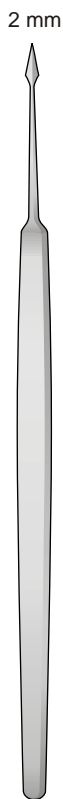

14-160-01  
125 mm

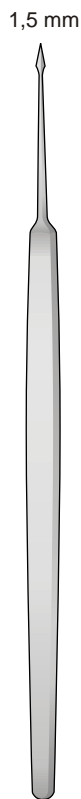

14-160-02  
125 mm

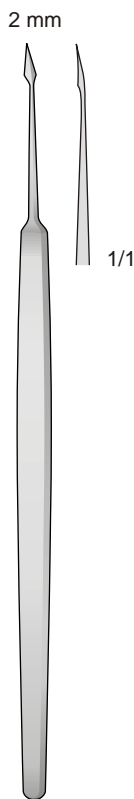

14-160-03  
125 mm

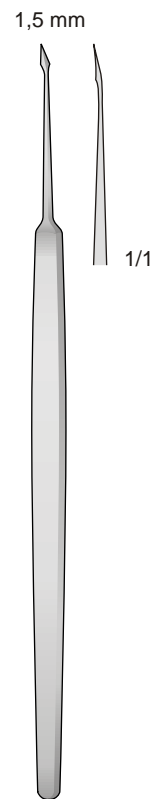

14-160-04  
125 mm



14-160-05  
125 mm

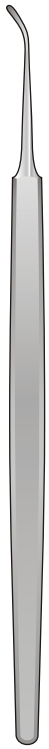

14-170-01  
125 mm



14-170-02  
120 mm



GRAEFE  
14-180  
140 mm

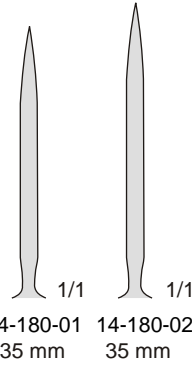

14-180-01 1/1  
35 mm  
14-180-02 1/1  
35 mm



GRAEFE  
14-190

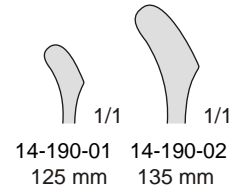

14-190-01 1/1  
125 mm  
14-190-02 1/1  
135 mm



1/1

WECKER  
14-200  
130 mm

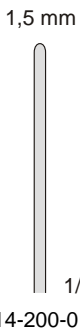

14-200-01 1/1

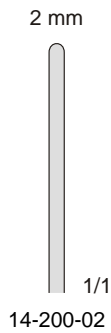

14-200-02 1/1

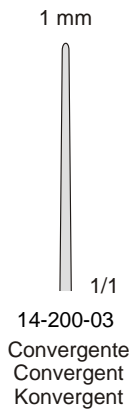

14-200-03 1/1  
Convergente  
Convergent  
Konvergent



GRAEFE  
14-210  
130 mm

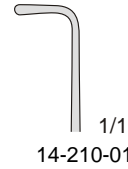

14-210-01 1/1

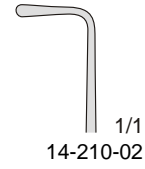

14-210-02 1/1



14-210-03 1/1



CASTROVIEJO  
14-220

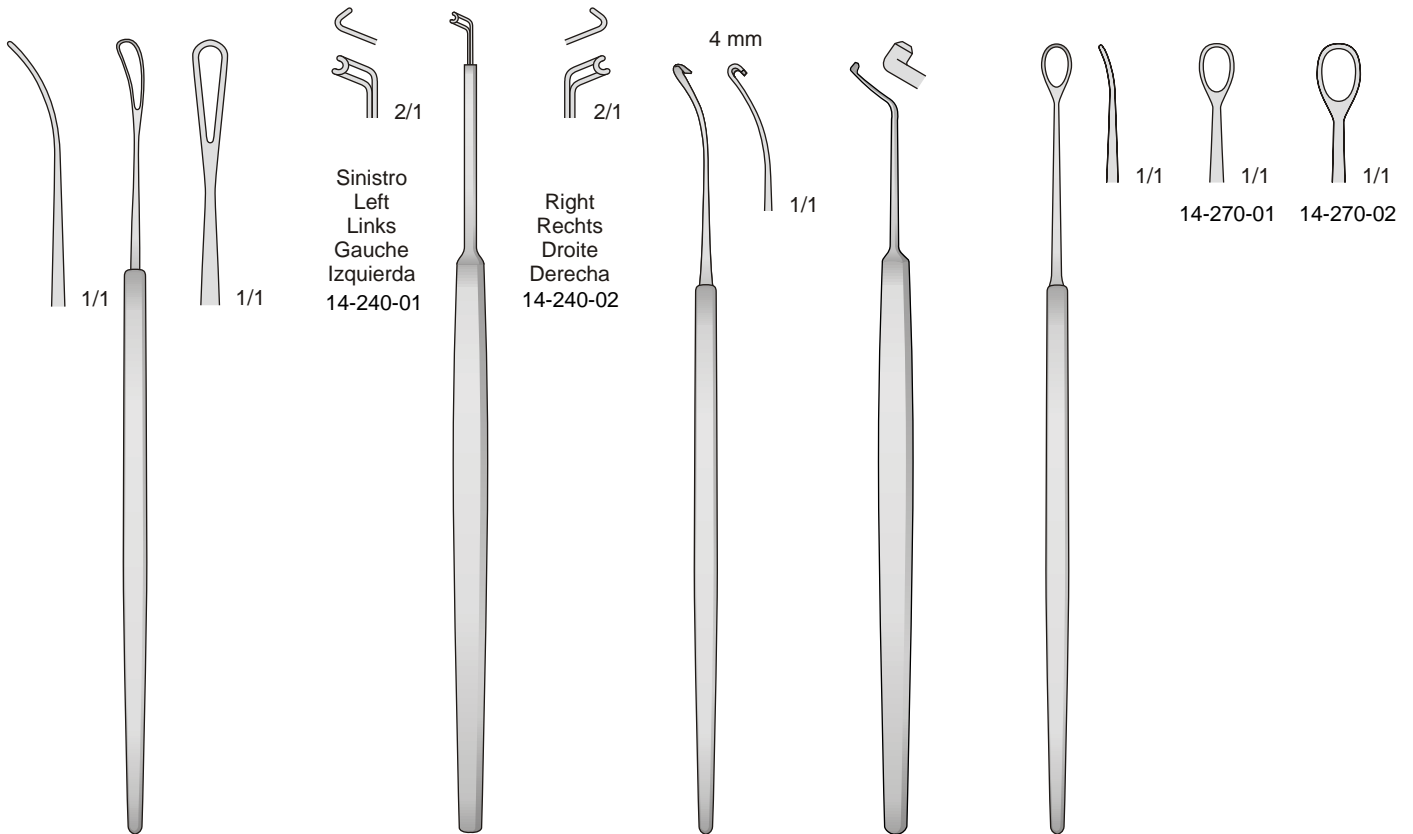
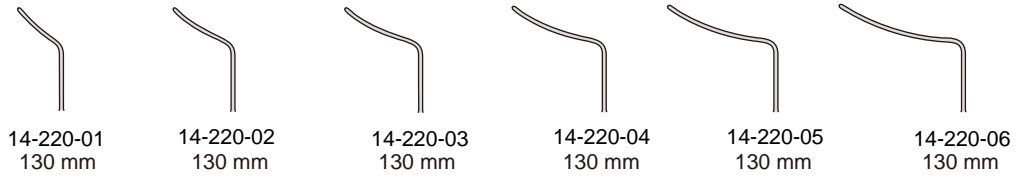

SNELLEN  
14-230-13  
135 mm

14-240  
140 mm

14-250-13  
130 mm

14-260-13  
130 mm

WEBER  
14-270  
135 mm

1,5 mm

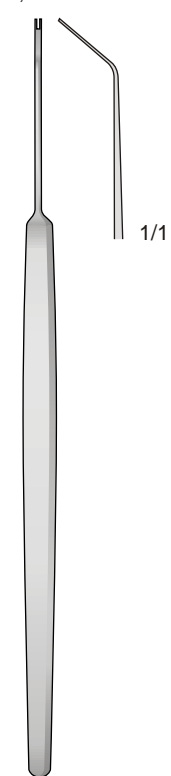

14-280-13  
130 mm

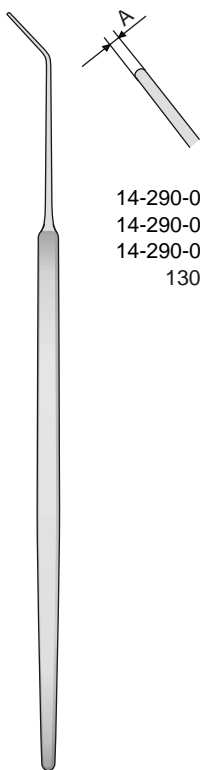

CASTROVIEJO  
14-290  
130 mm

A  
14-290-01 0,6 mm  
14-290-02 1,0 mm  
14-290-03 1,5 mm  
130 mm

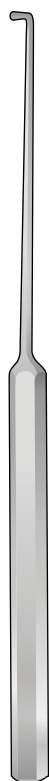

14-300-14  
140 mm



14-300-16  
165 mm



KIMURA  
14-310-15  
150 mm

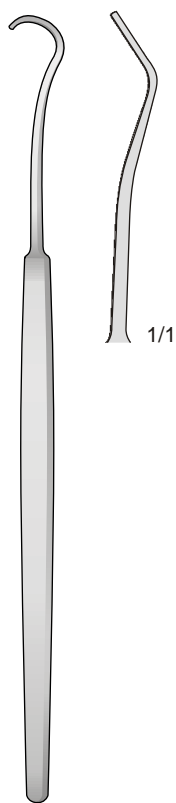

ARRUGA  
14-320-14  
140 mm

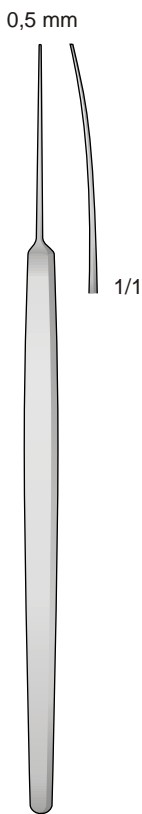

14-330-01  
130 mm

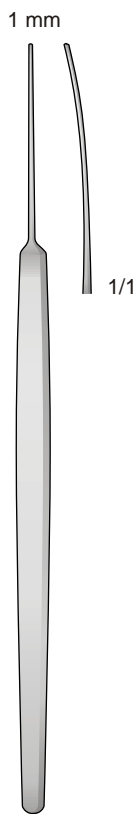

14-330-02  
130 mm

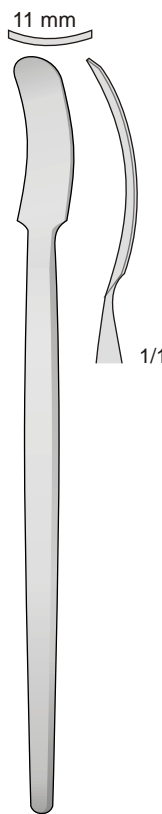

14-340-12  
125 mm

Dilatatori lacriminali  
Tränenkanal Dilatadoren  
Lacrymal dilators  
Dilatadores lacrimales

Fig.1

Fig.2

Fig.3



WILDER  
14-350-01  
100 mm



WILDER  
14-350-02  
100 mm



WILDER  
14-350-03  
100 mm

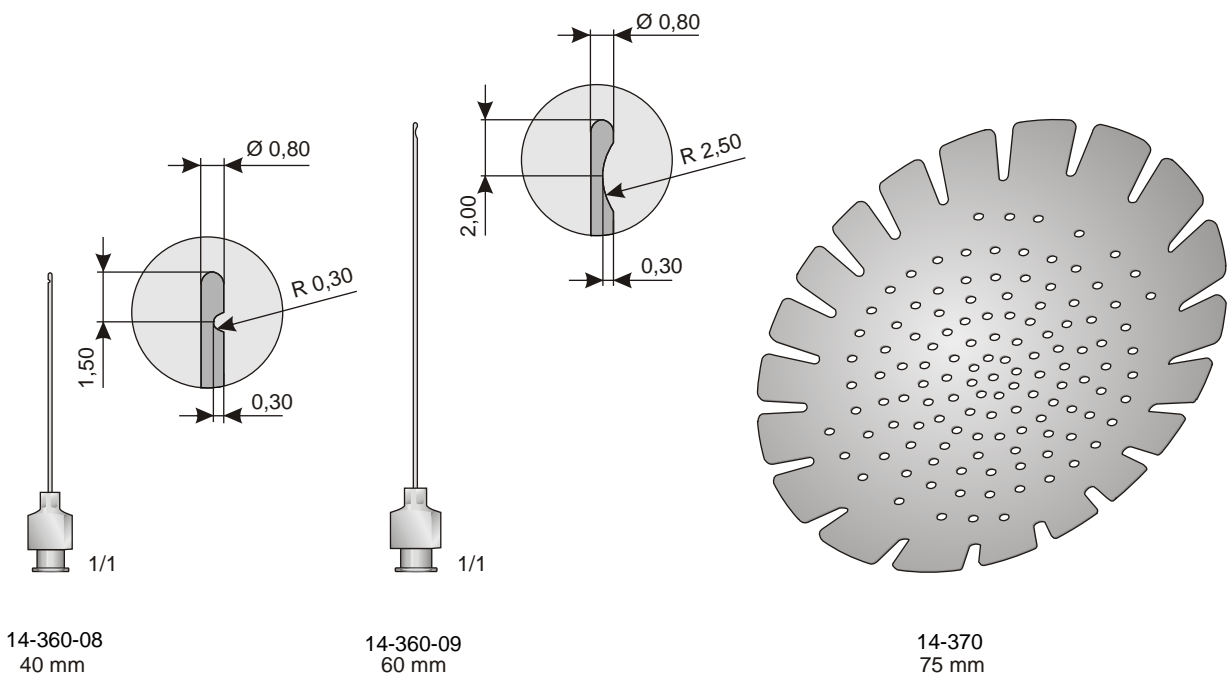
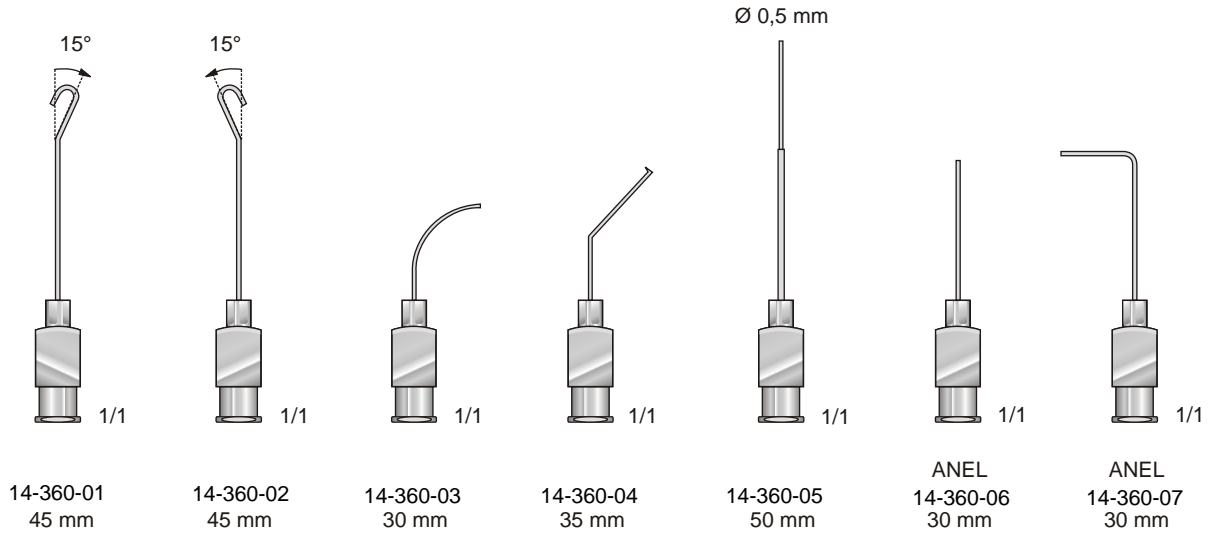

Micro Pinzette - Micro Forceps - Mikro Pinzetten - Micro pinces - Pinzas finos

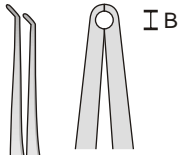

**B**  
14-380-01 0,2 mm  
14-380-02 0,3 mm  
14-380-03 0,4 mm

**PIERSE**  
14-380  
80 mm

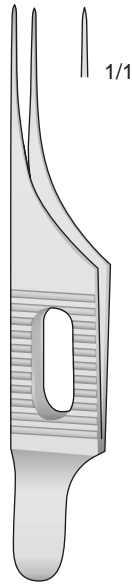

**COLIBRI**  
14-390-08  
80 mm

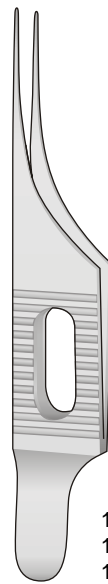

**A**  
14-400-01 0,25 mm  
14-400-02 0,4 mm  
14-400-03 0,6 mm

**COLIBRI**  
14-400  
75 mm

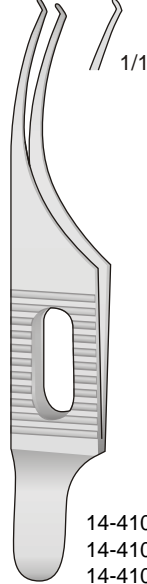

**A**  
14-410-01 0,25 mm  
14-410-02 0,4 mm  
14-410-03 0,6 mm

**COLIBRI**  
14-410  
80 mm

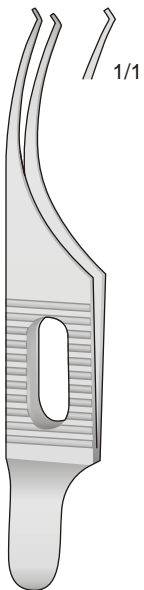

**COLIBRI**  
14-420-08  
80 mm



14-430-07  
70 mm

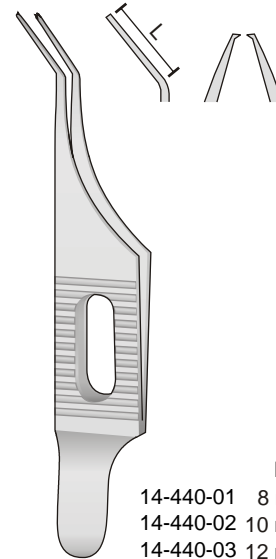

**L**  
14-440-01 8 mm  
14-440-02 10 mm  
14-440-03 12 mm

14-440  
70 mm

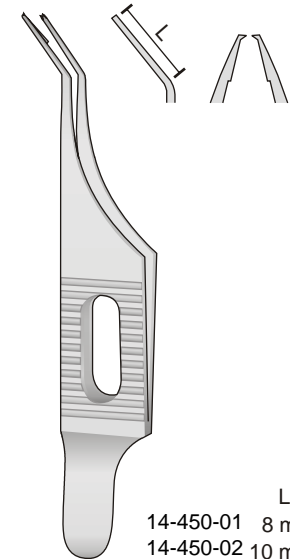

**L**  
14-450-01 8 mm  
14-450-02 10 mm

14-450  
70 mm

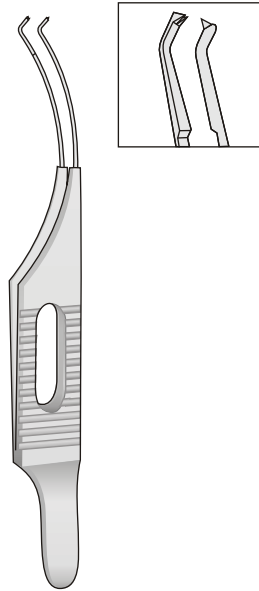

BARRAQUER  
14-460-01

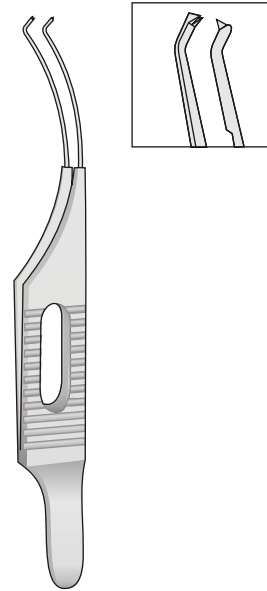

BARRAQUER  
14-460-02

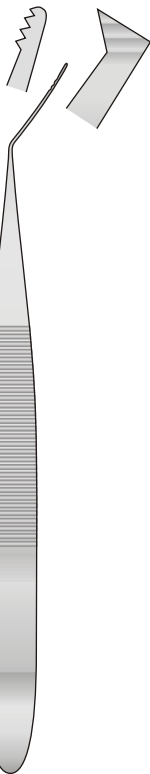

14-470-09  
95 mm

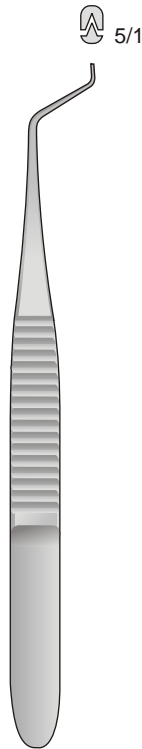

14-480-09  
90 mm

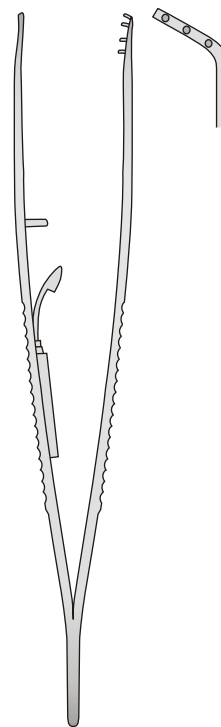

14-490-09  
95 mm

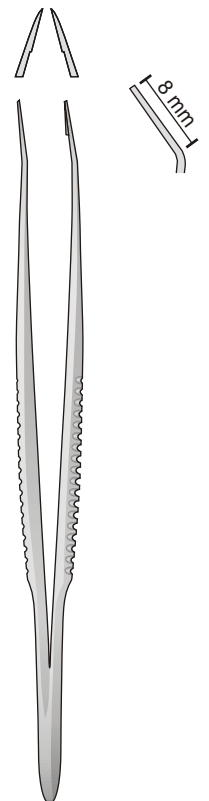

Mc PHERSON  
14-500-09  
95 mm



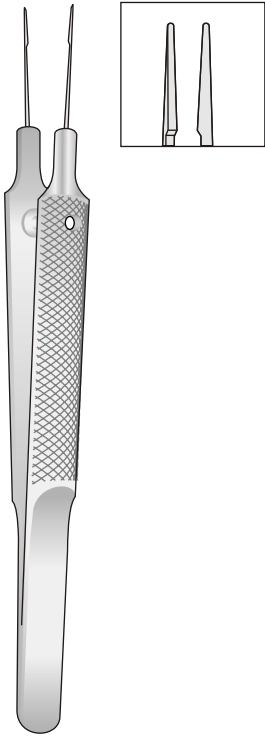

14-510-01

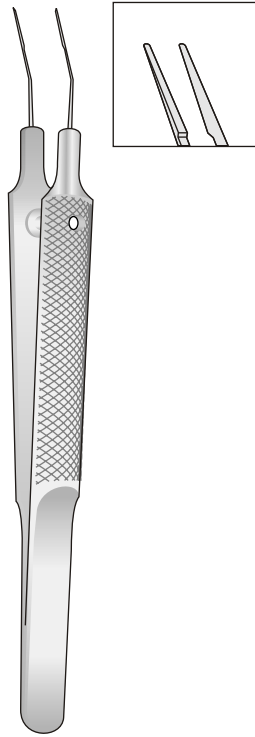

14-510-02

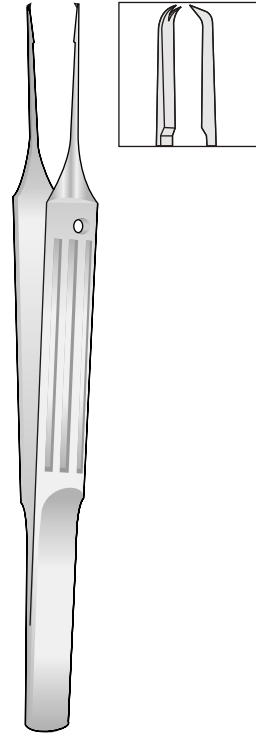

CASTROVIEJO  
14-520-01

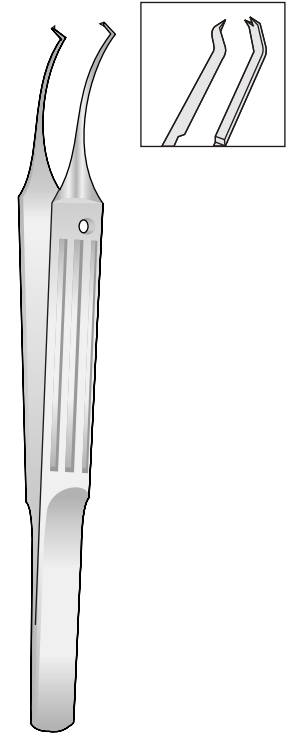

TROUTMAN  
14-530-01

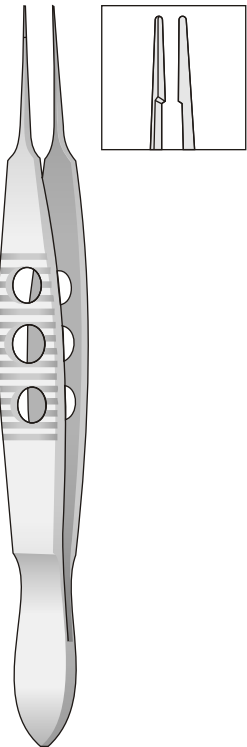

MC PHERSON  
14-540-01

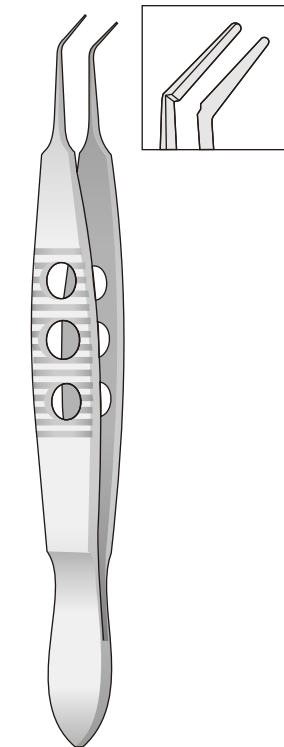

MC PHERSON  
14-540-02

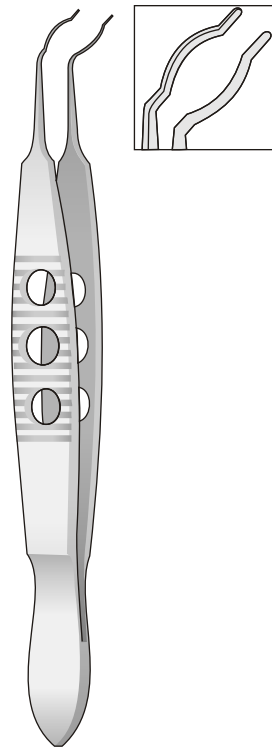

OSHIKA-FAULKNER  
14-550-01

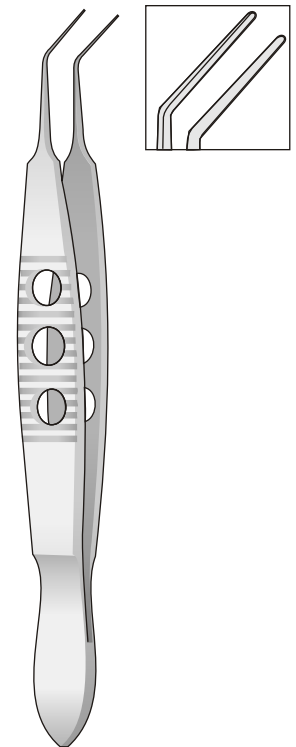

FAULKNER  
14-560-01

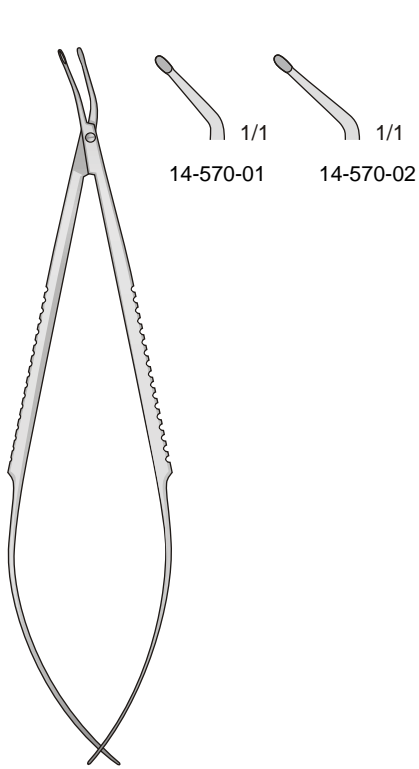

14-570  
110 mm

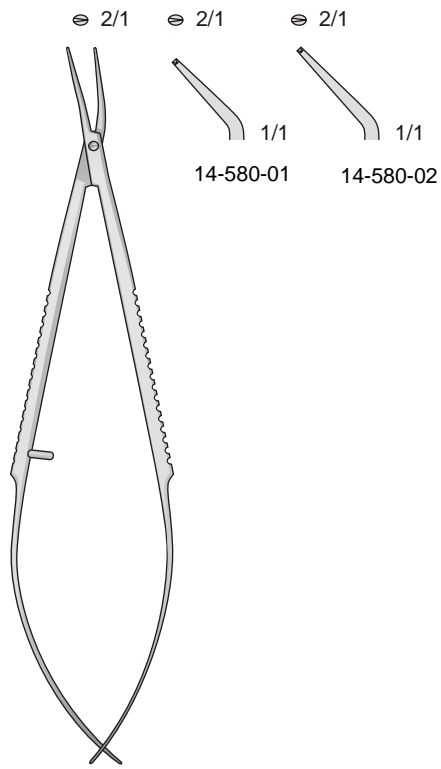

14-580  
110 mm

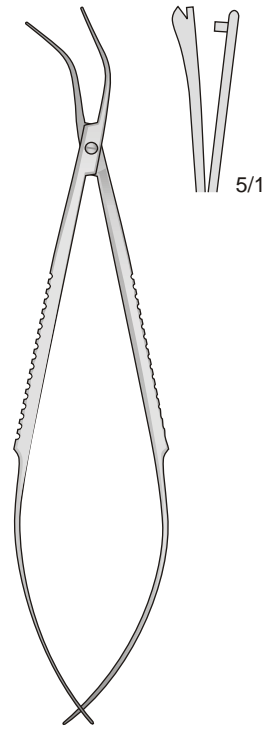

14-590-11  
110 mm

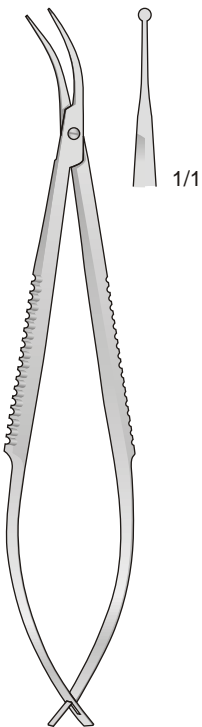

14-600-01  
110 mm

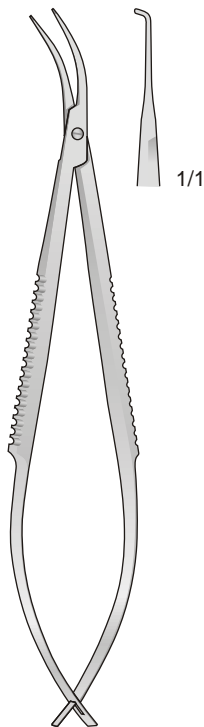

14-600-02  
110 mm

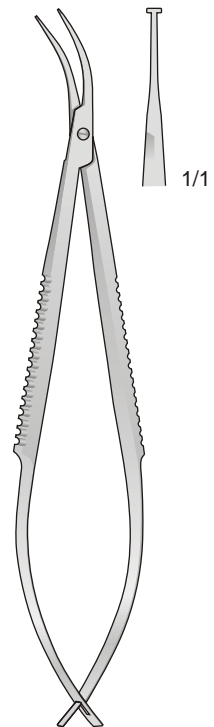

14-600-03  
110 mm

Blefarostati - Eye specula - Sperrelevatoren  
Blèpharostats - Blefarostatos

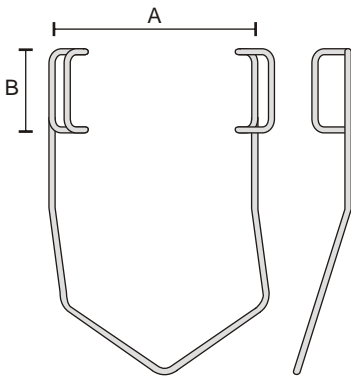

14-610-01    A    B  
27 mm    11 mm

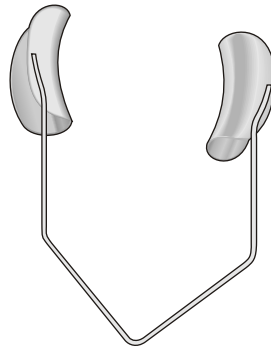

BARRAQUER  
14-620-02

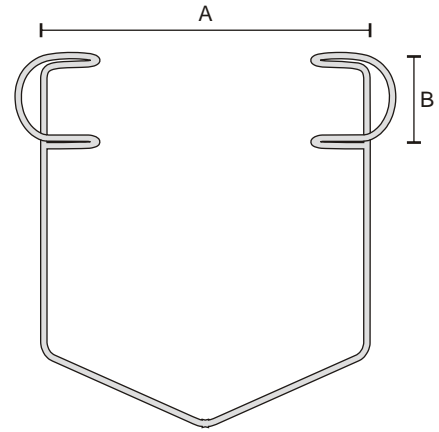

	A	B
14-630-01	27 mm	5 mm
14-630-02	34 mm	9 mm
14-630-03	42 mm	12 mm
14-630-04	42 mm	14 mm

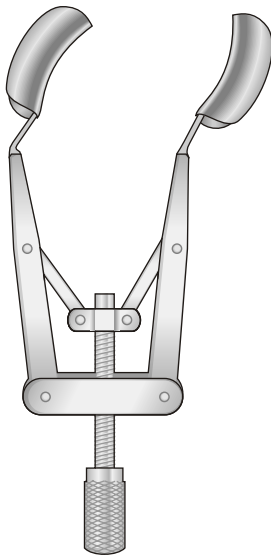

KERSHNER  
14-640-01

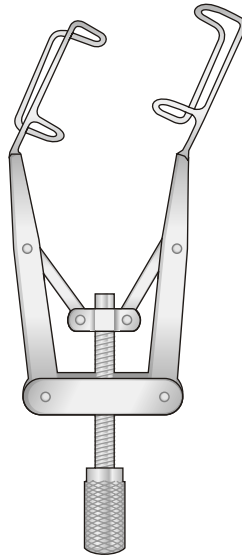

KERSHNER  
14-640-02

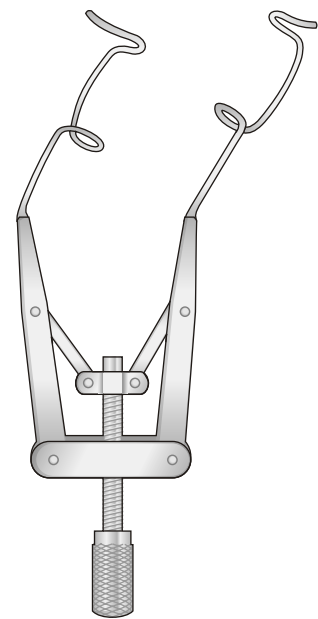

LIEBERMANN-TENNANT  
14-650-01

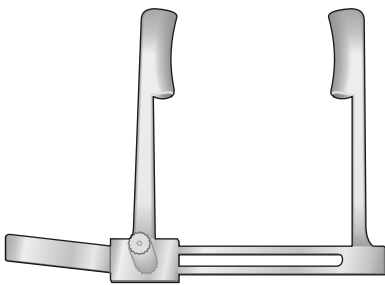

PROST  
14-660

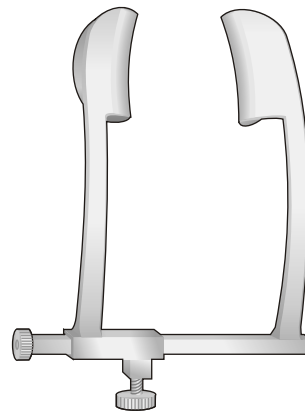

COOK  
14-670

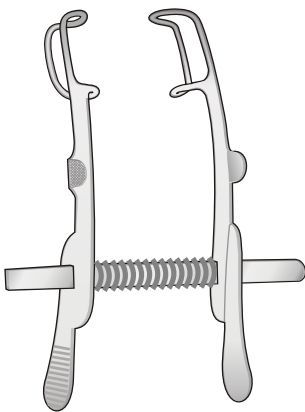

MELLINGER  
14-680  
70 mm

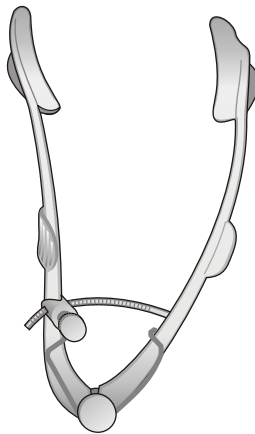

LISTER-BURCH  
14-690  
80 mm

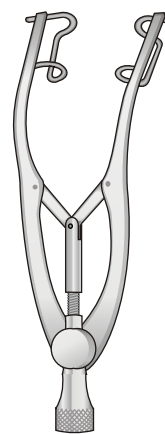

CASTROVIEJO  
14-700  
80 mm

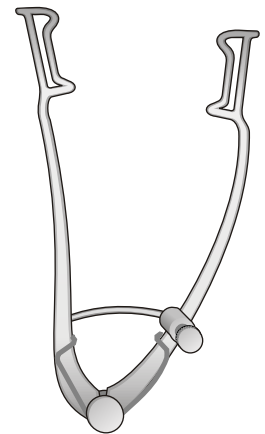

WILLIAMS  
14-710  
80 mm

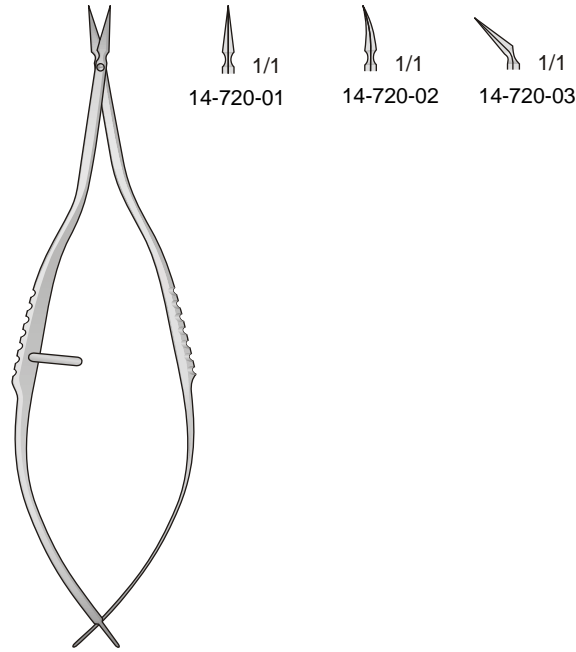

 1/1  
14-720-01

 1/1  
14-720-02

 1/1  
14-720-03

VANNAS  
14-720  
85 mm

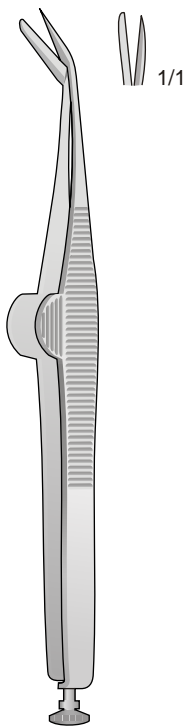

WECKER  
14-730-01  
110 mm

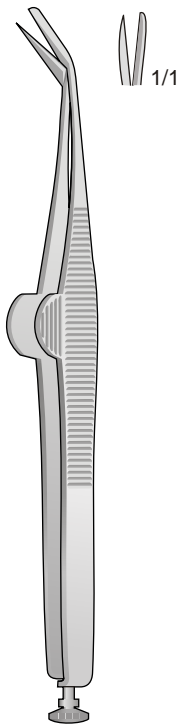

WECKER  
14-730-02  
110 mm

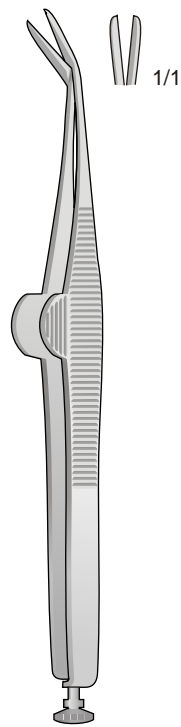

WECKER  
14-730-03  
110 mm

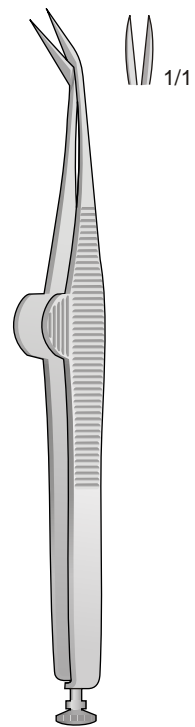

WECKER  
14-730-04  
110 mm

Acuta - Sharp - Spitz  
Pointu - Agudas

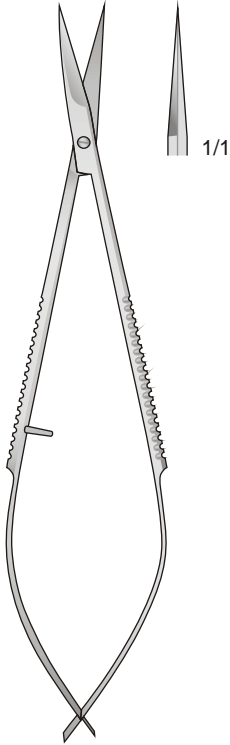

NOYES  
14-740-01  
120 mm

Acuta - Sharp - Spitz  
Pointu - Agudas

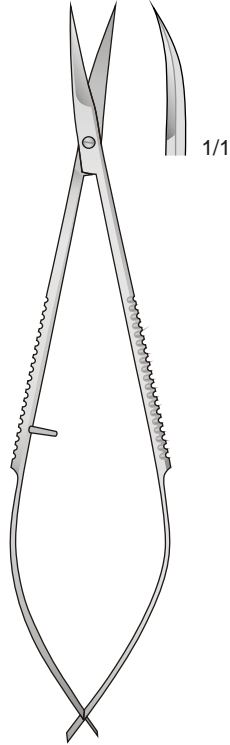

NOYES  
14-740-02  
120 mm

Acuta - Sharp - Spitz  
Pointu - Agudas

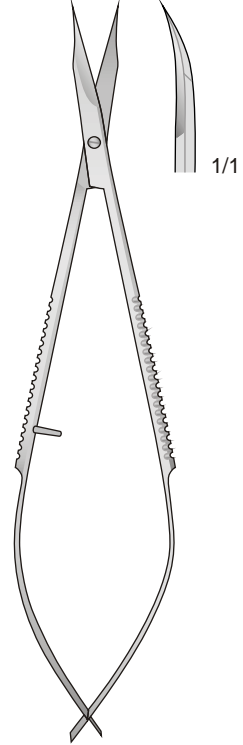

WESTCOTT  
14-750-01  
120 mm

Acuta - Sharp - Spitz  
Pointu - Agudas

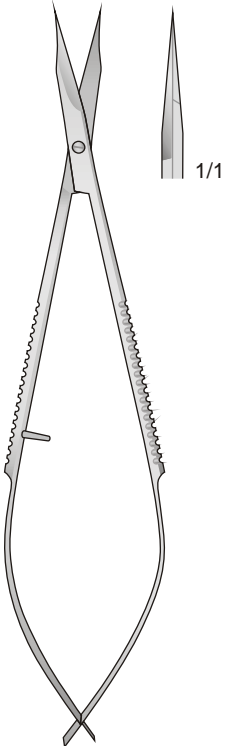

WESTCOTT  
14-750-02  
120 mm

Smussa - Blunt - Stumpf  
Mousse - Romas

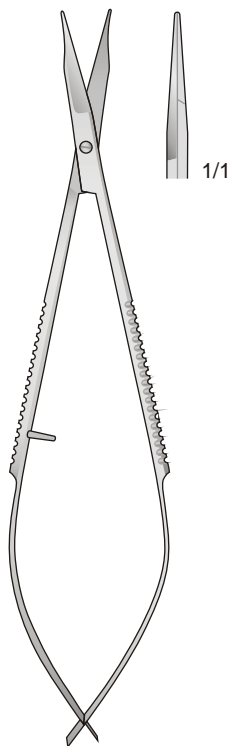

WESTCOTT  
14-760-01  
120 mm

Smussa - Blunt - Stumpf  
Mousse - Romas

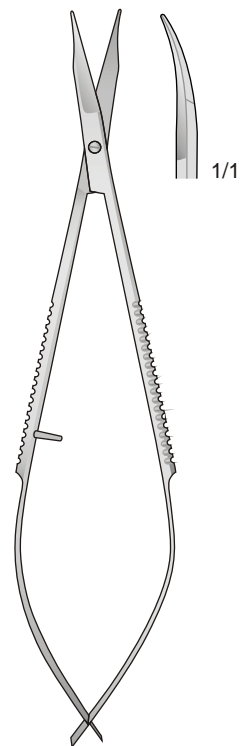

WESTCOTT  
14-760-02  
120 mm

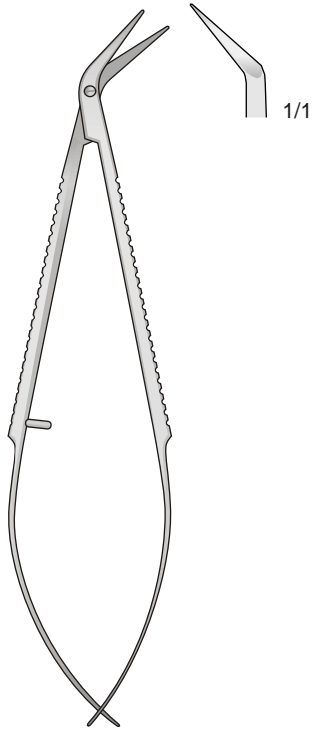

14-770-11  
110 mm

Acuta - Sharp  
Spitz - Pointu - Agudas

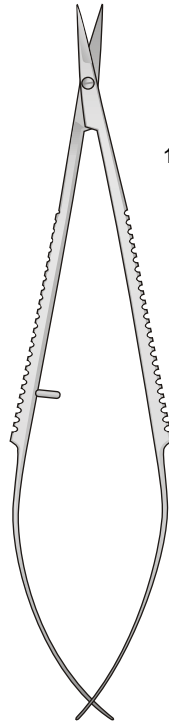

14-780  
110 mm

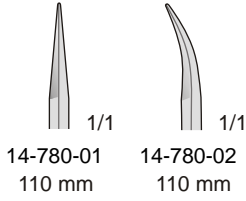

14-780-01  
110 mm

14-780-02  
110 mm

Acuta - Sharp  
Spitz - Pointu - Agudas

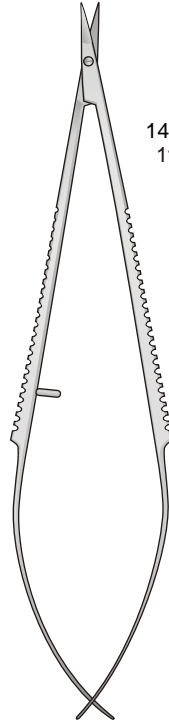

14-790  
110 mm

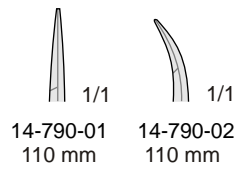

14-790-01  
110 mm

14-790-02  
110 mm

Smussa - Blunt  
Stumpf - Mousse - Romas

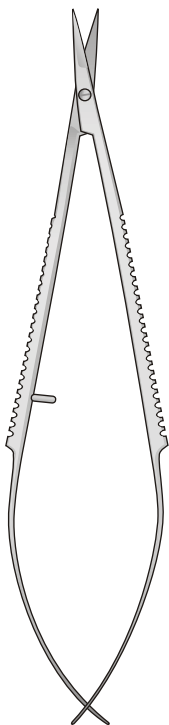

14-800  
110 mm

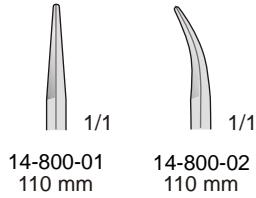

14-800-01  
110 mm

14-800-02  
110 mm

Smussa - Blunt  
Stumpf - Mousse - Romas

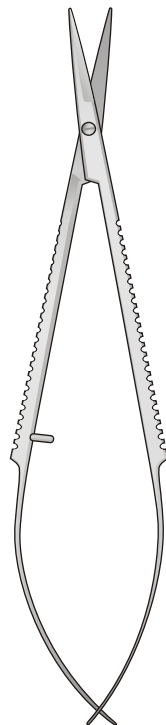

14-810  
120 mm

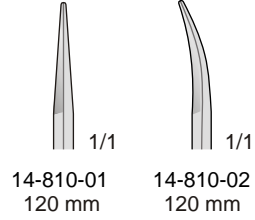

14-810-01  
120 mm

14-810-02  
120 mm

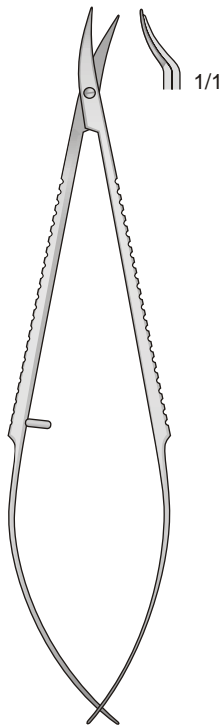

TROUTMAN  
14-820-01  
110 mm

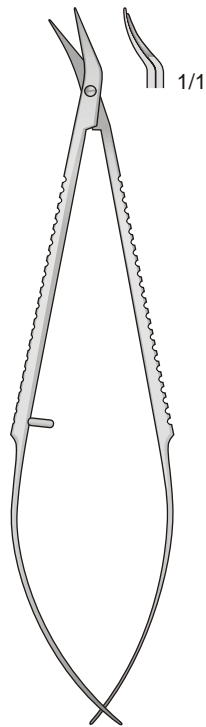

TROUTMAN  
14-820-02  
110 mm

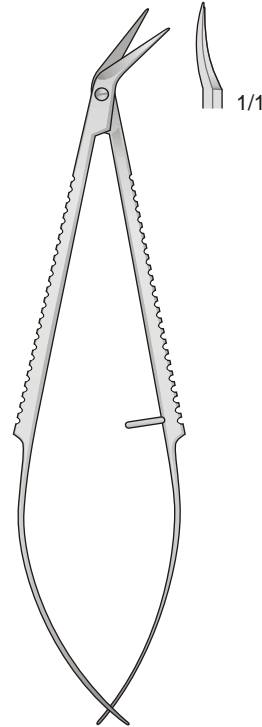

CASTROVIEJO  
14-830-01  
110 mm

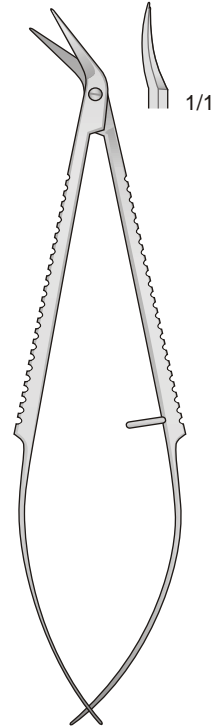

CASTROVIEJO  
14-830-02  
110 mm

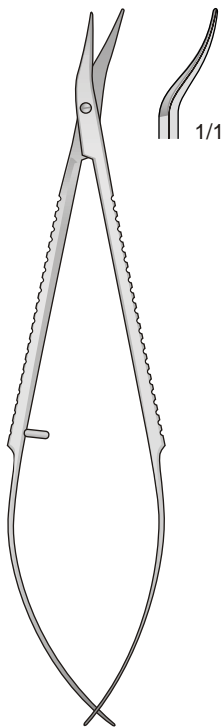

CASTROVIEJO  
14-830-03  
110 mm

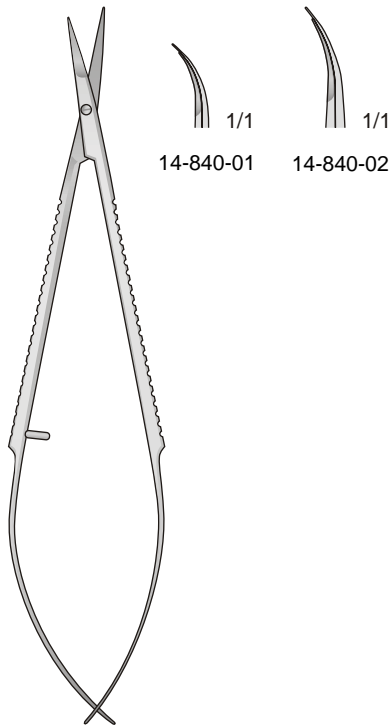

14-840-01

14-840-02

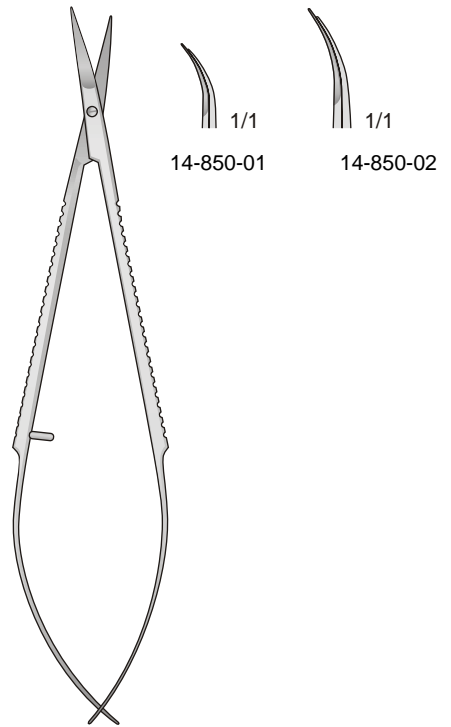

14-850-01

14-850-02

14-850  
110 mm



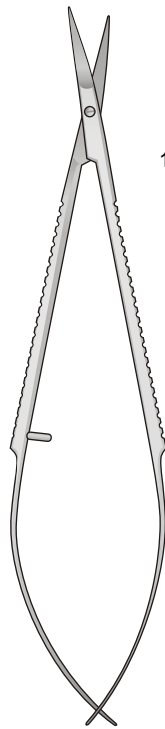

14-860



14-860-01  
110 mm

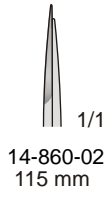

14-860-02  
115 mm

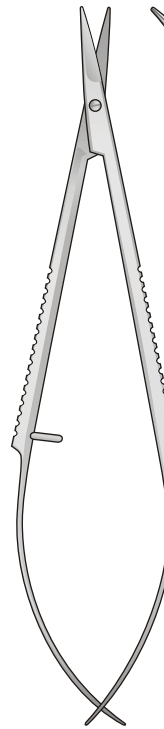

14-870-01  
110 mm



1/1

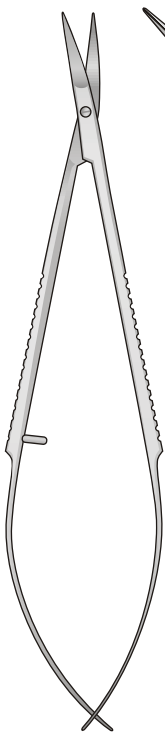

14-870-02  
110 mm

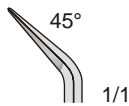

45°

1/1

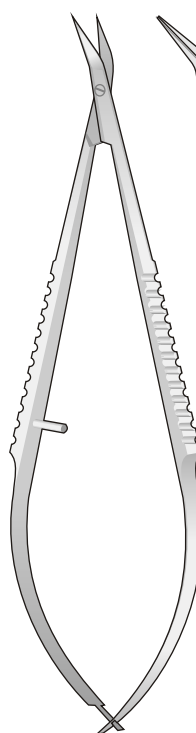

14-880-11  
110 mm



1/1

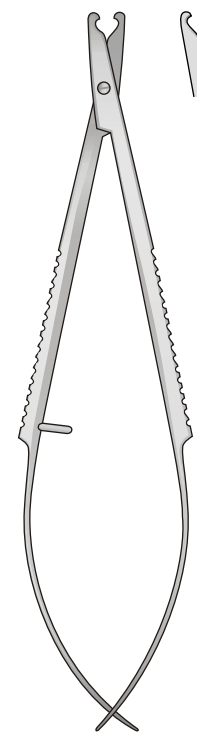

14-890-11  
110 mm



1/1

Acuta - Sharp - Spitz - Pointu - Agudas

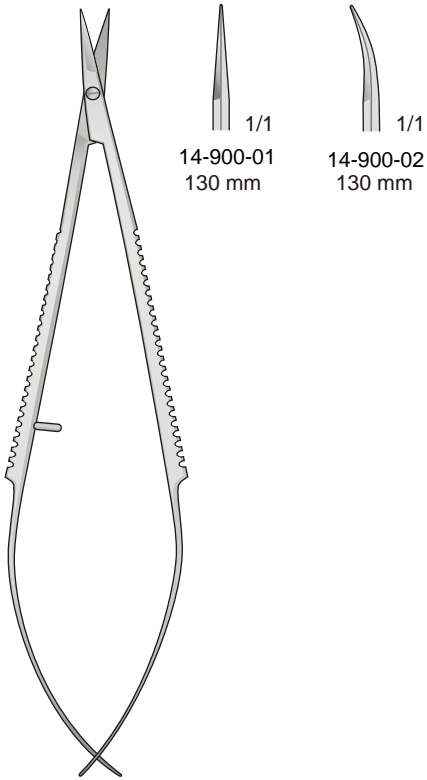

14-900  
130 mm

Acuta - Sharp - Spitz - Pointu - Agudas

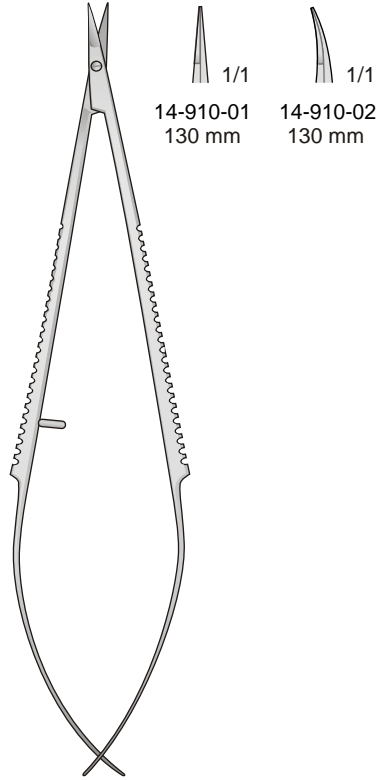

14-910  
130 mm

Smussa - Blunt - Stumpf - Mousse - Romas

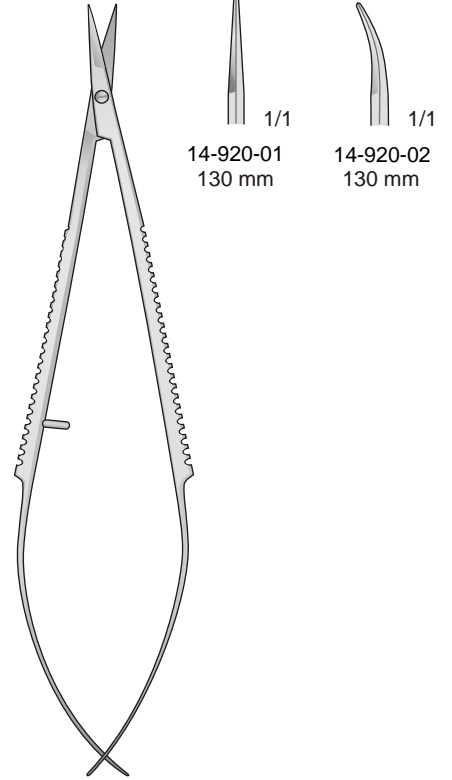

14-920  
130 mm

Acuta - Sharp - Spitz - Pointu - Agudas

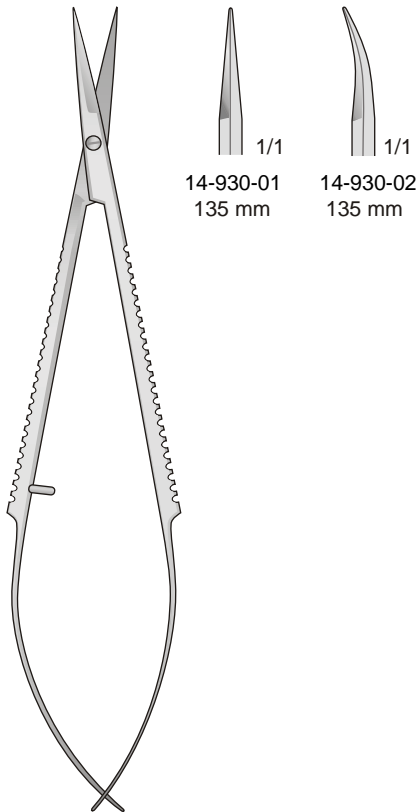

14-930  
135 mm

Smussa - Blunt - Stumpf - Mousse - Romas

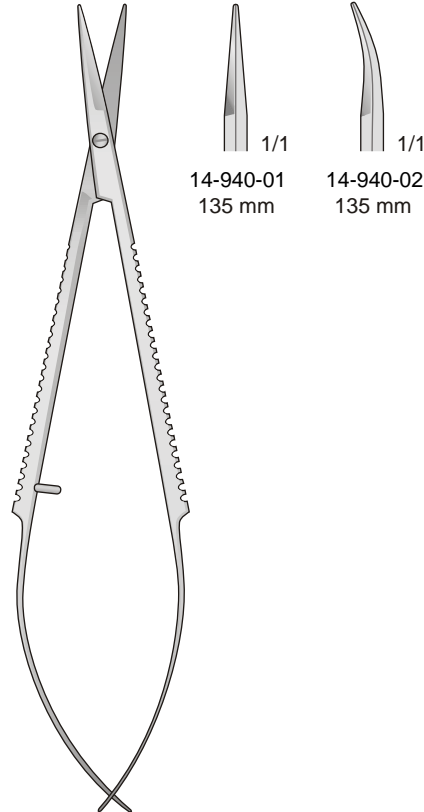

14-940  
135 mm

Acuta - Sharp  
Spitz - Pointu - Agudas

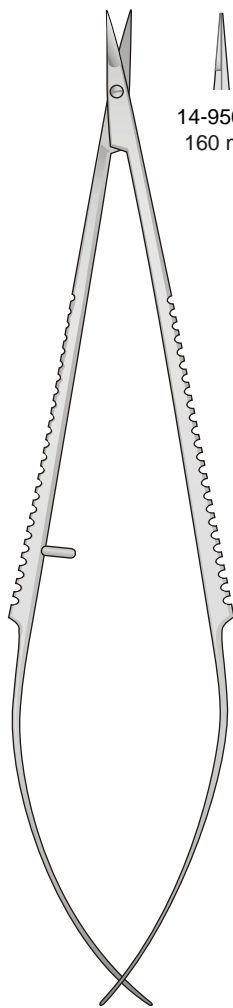

14-950  
160 mm

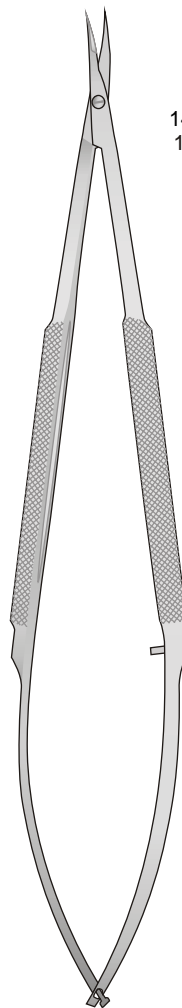
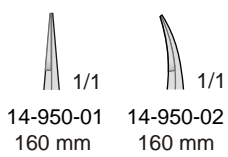

14-960  
150 mm

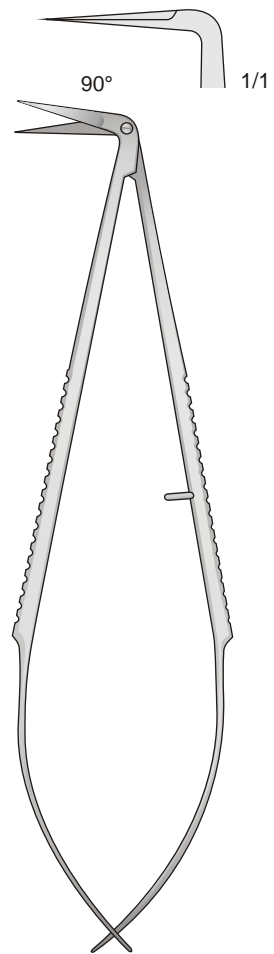
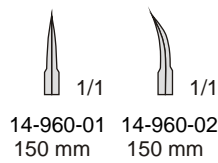

14-970  
150 mm

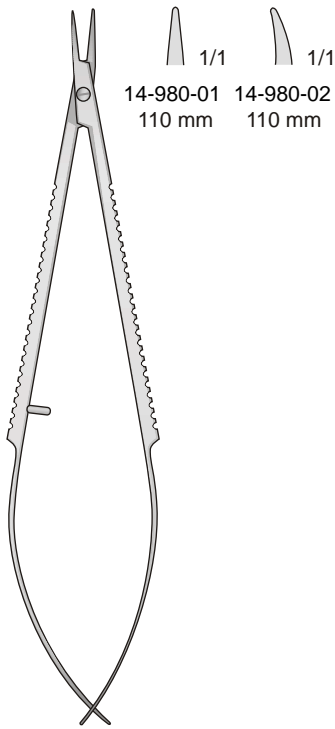

14-980  
110 mm

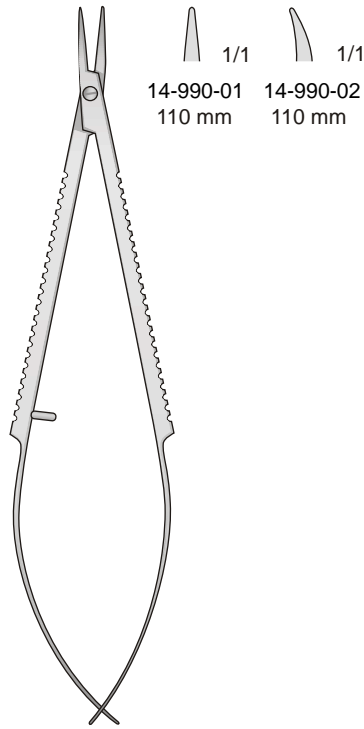

14-990  
110 mm

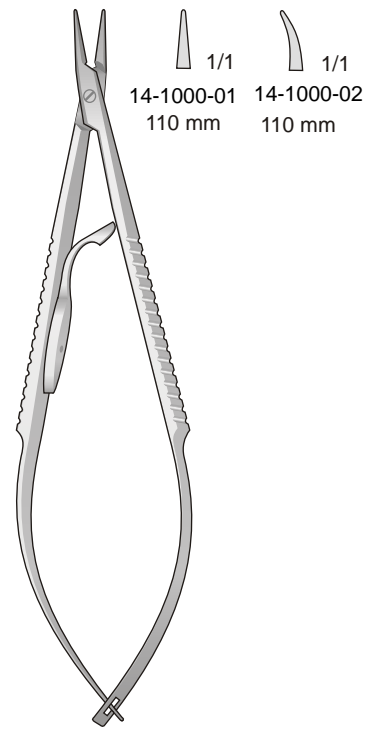

14-1000  
110 mm

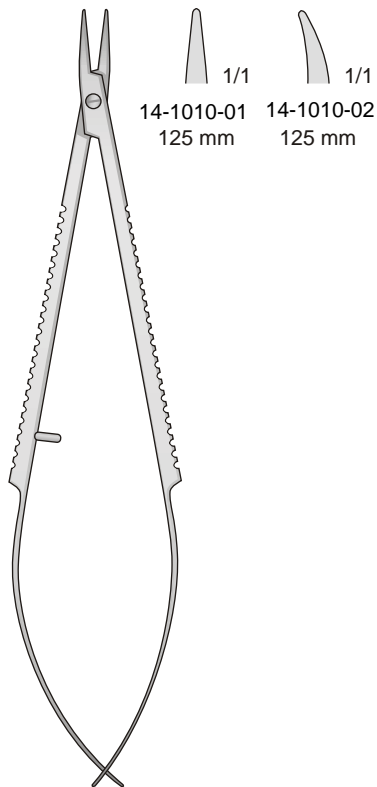

14-1010  
125 mm

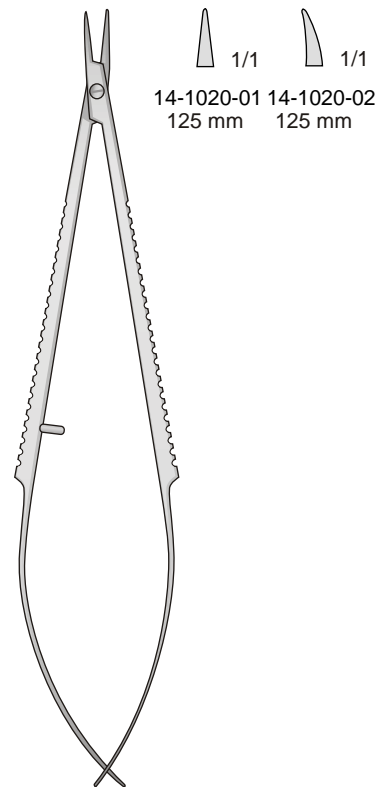

14-1020  
125 mm

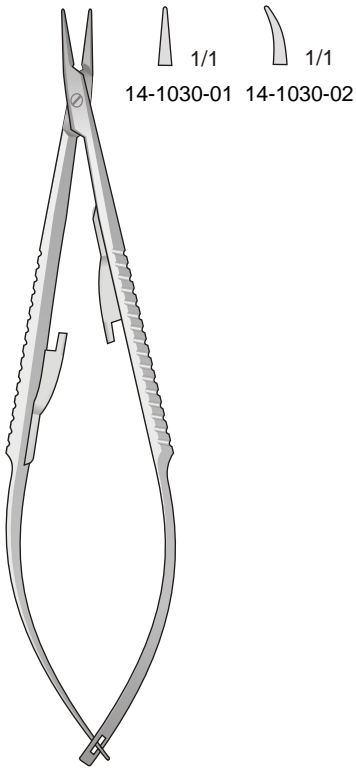

14-1030  
125 mm

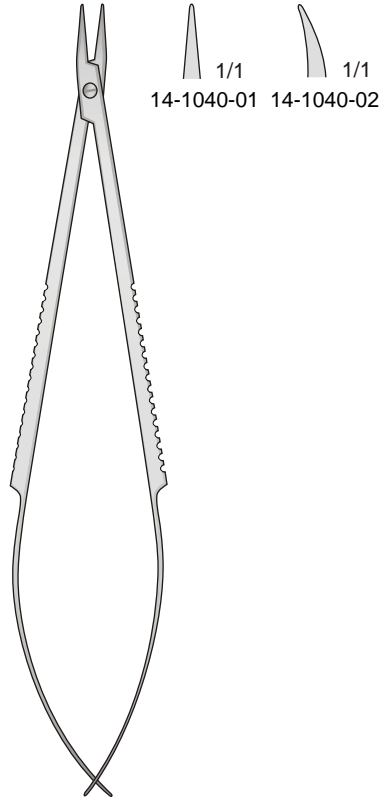

14-1040  
135 mm

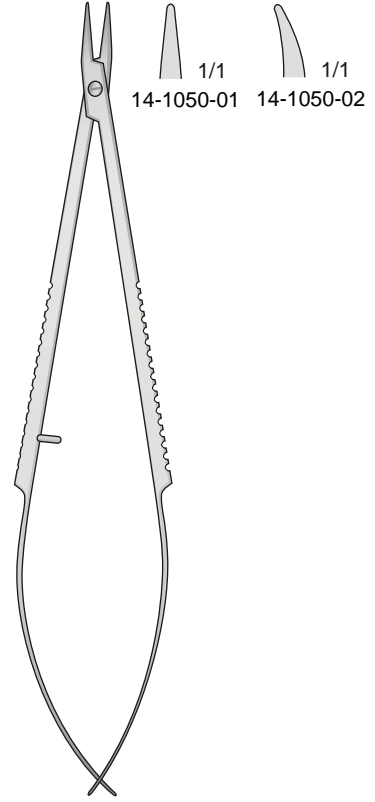

14-1050  
135 mm

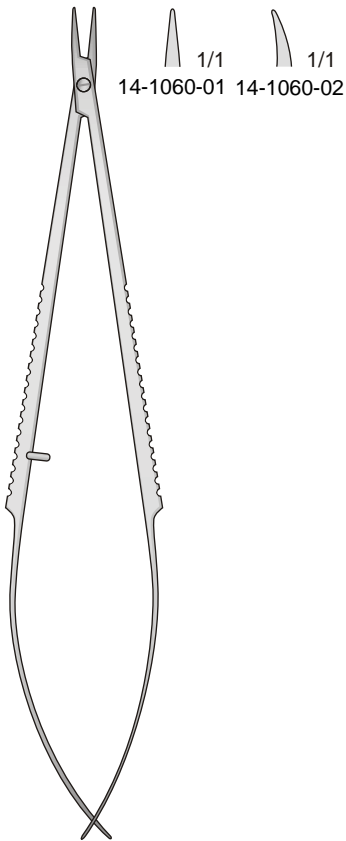

14-1060  
135 mm

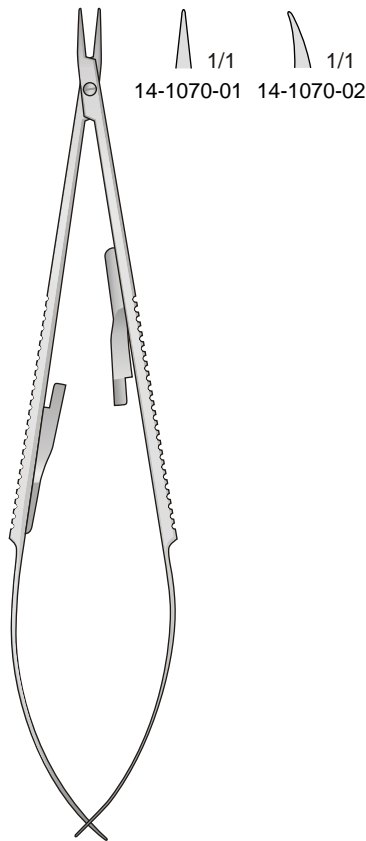

14-1070  
135 mm

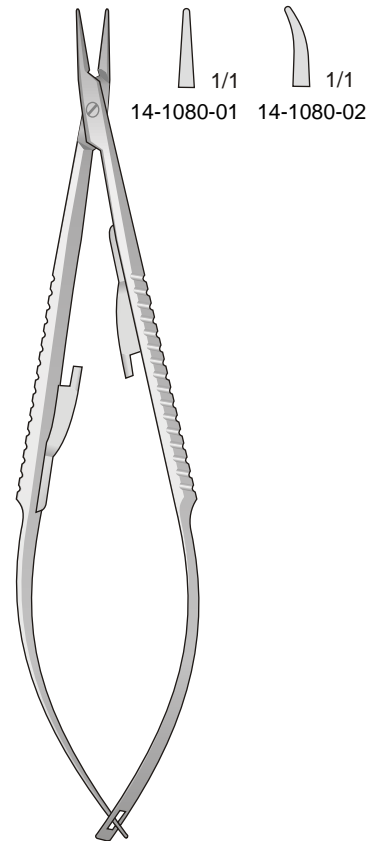

14-1080  
135 mm

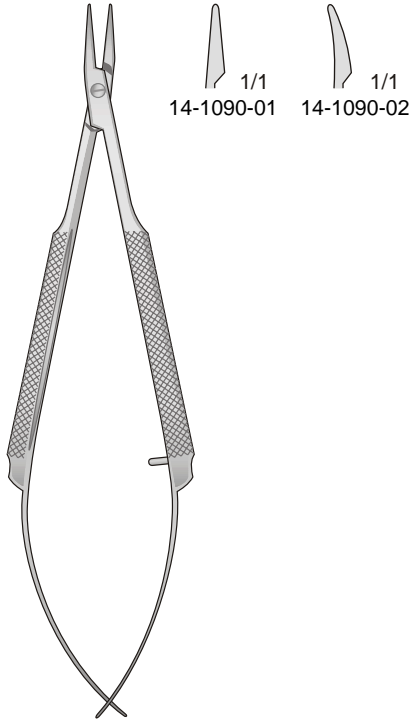

CASTROVIEJO  
14-1090  
110 mm

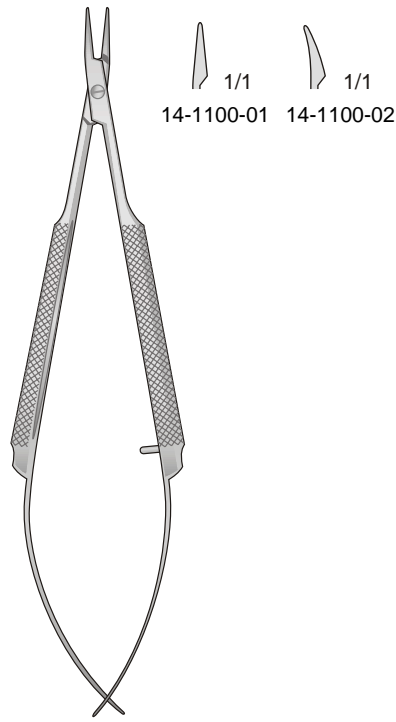

CASTROVIEJO  
14-1100  
110 mm

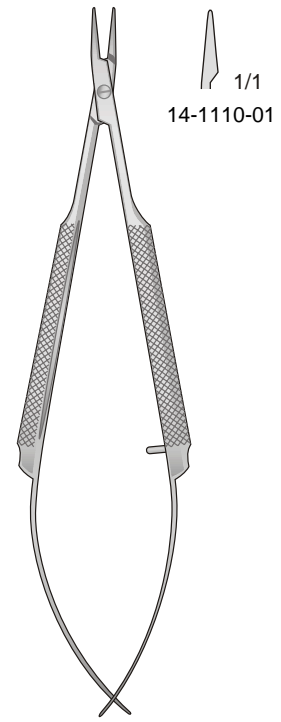

CASTROVIEJO  
14-1110  
110 mm

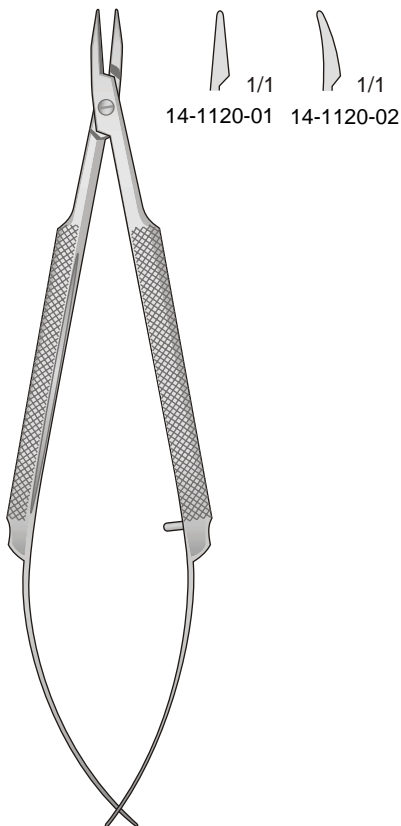

CASTROVIEJO  
14-1120  
125 mm

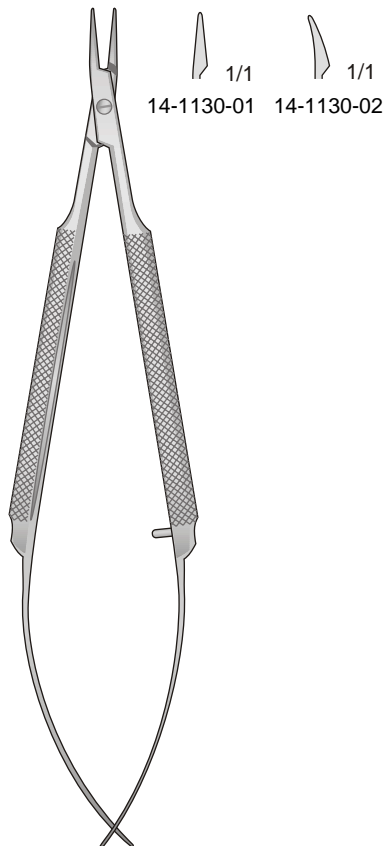

CASTROVIEJO  
14-1130  
125 mm

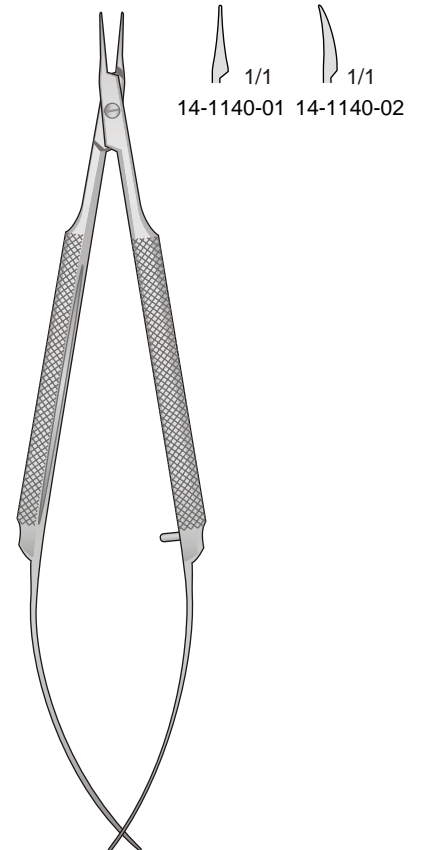

BARRAQUER  
14-1140  
125 mm

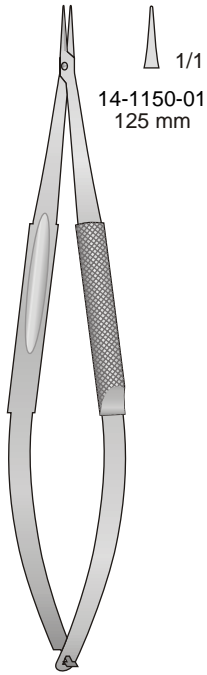

14-1150-01  
125 mm

14-1150-02  
125 mm

**BARRAQUER**  
14-1150  
125 mm

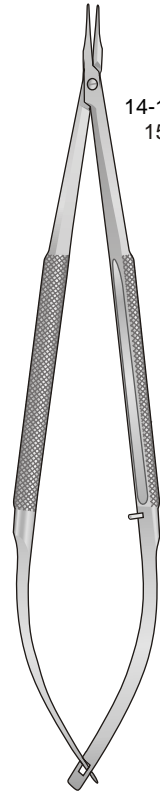

14-1160-01  
150 mm

14-1160-02  
150 mm

**BARRAQUER**  
14-1160  
150 mm

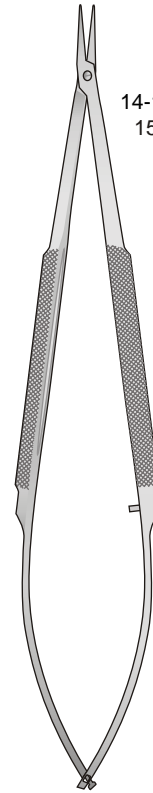

14-1170-01  
150 mm

14-1170-02  
150 mm

**REILL**  
14-1170  
150 mm

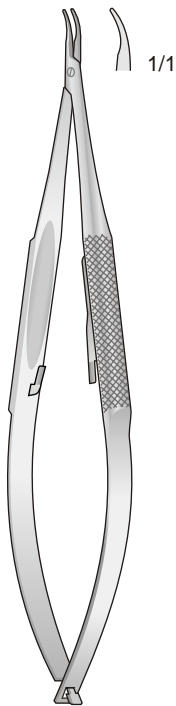

1/1

**BARRAQUER**  
14-1180  
120 mm

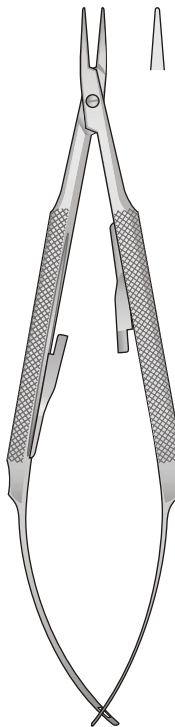

1/1

**BARRAQUER**  
14-1180-02  
125 mm

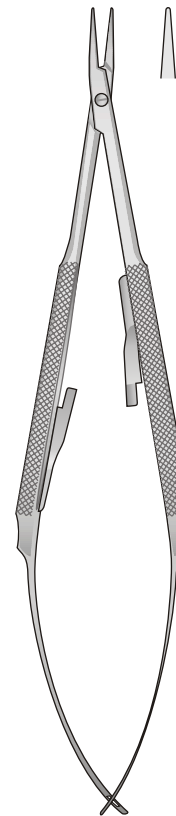

1/1

**BARRAQUER**  
14-1180-03  
150 mm

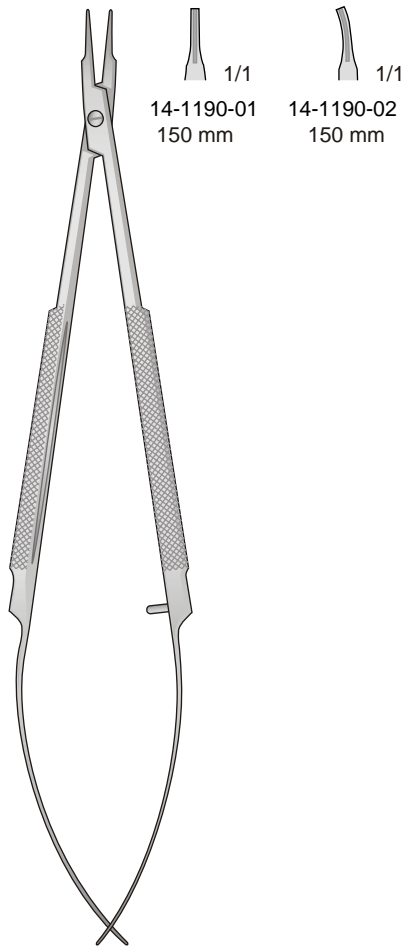

**BARRAQUER**  
14-1190  
150 mm

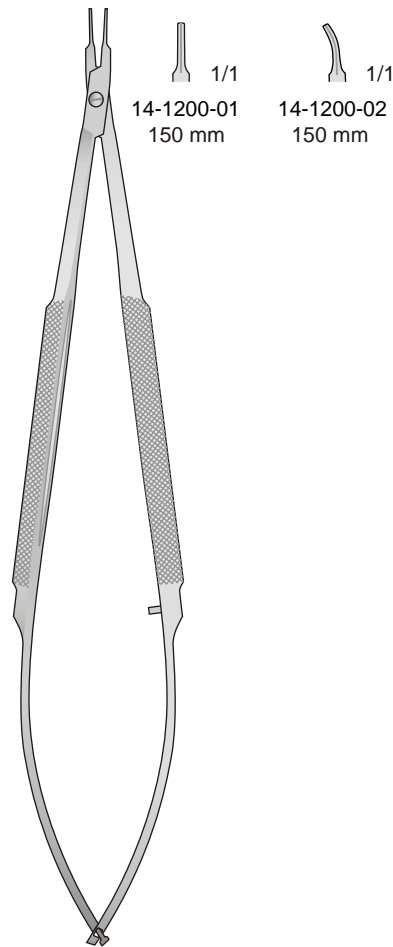

**BARRAQUER**  
14-1200  
150 mm

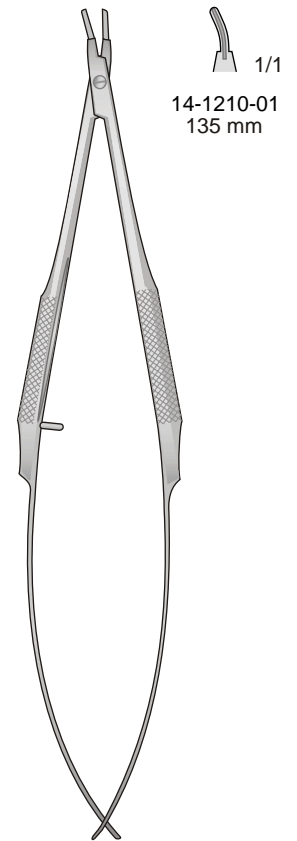

**BARRAQUER**  
14-1210  
135 mm



Micro pinzette  
Micro forceps  
Mikro Pinzetten  
Micro pincers  
Pinzas finos

1 x 2 Denti  
1 x 2 Teeth  
1 x 2 Zähne  
1 x 2 Dents  
1 x 2 Dientes

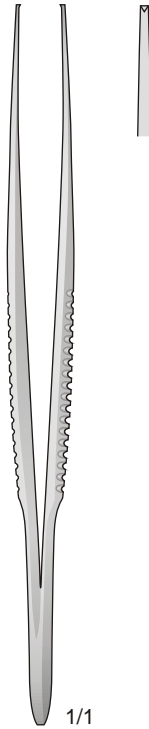

1/1

1 x 2 Denti  
1 x 2 Teeth  
1 x 2 Zähne  
1 x 2 Dents  
1 x 2 Dientes

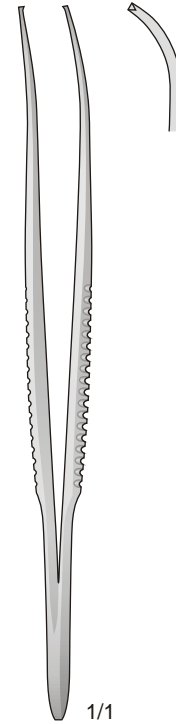

1/1

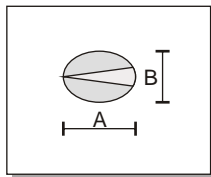

A	B		
0,4	0,25	14-1220-01	14-1230-01
0,5	0,35	14-1220-02	14-1230-02
0,7	0,55	14-1220-03	14-1230-03
1	0,8	14-1220-04	14-1230-04
1,2	0,9	14-1220-05	14-1230-05
		95 mm	95 mm

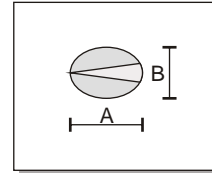

Micro pinzette  
Micro forceps  
Mikro Pinzetten  
Micro pincers  
Pinzas finos

1 x 2 Denti  
1 x 2 Teeth  
1 x 2 Zähne  
1 x 2 Dents  
1 x 2 Dientes

1 x 2 Denti  
1 x 2 Teeth  
1 x 2 Zähne  
1 x 2 Dents  
1 x 2 Dientes

Acuta  
Sharp  
Spitz  
Pointu  
Agudas

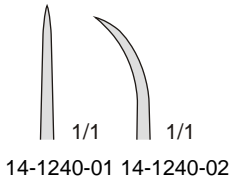

Smussa  
Blunt  
Stumpf  
Mousse  
Romas

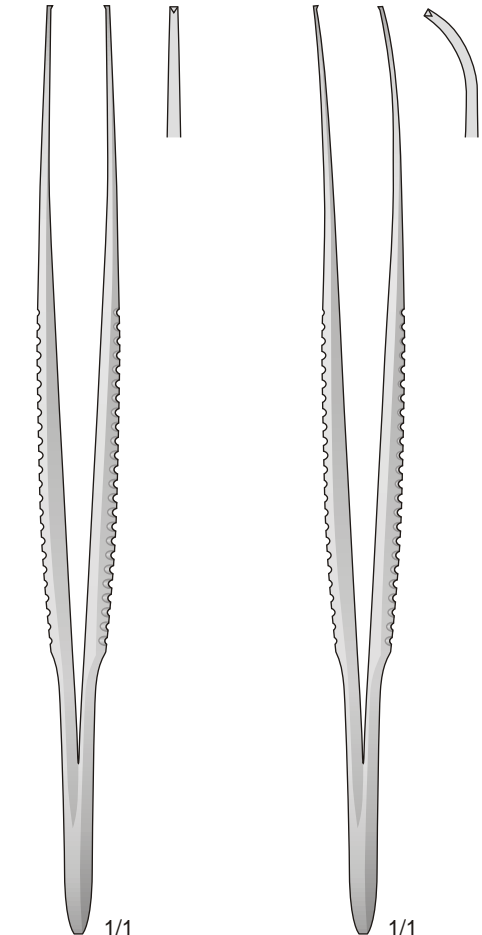
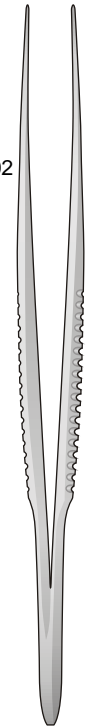
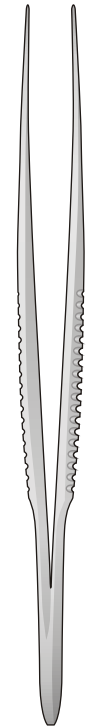
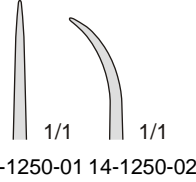

14-1240  
95 mm

14-1250  
95 mm

A	B		
0,4	0,25	14-1260-01	14-1270-01
0,5	0,35	14-1260-02	14-1270-02
0,7	0,55	14-1260-03	14-1270-03
1	0,8	14-1260-04	14-1270-04
1,2	0,9	14-1260-05	14-1270-05
		125 mm	125 mm

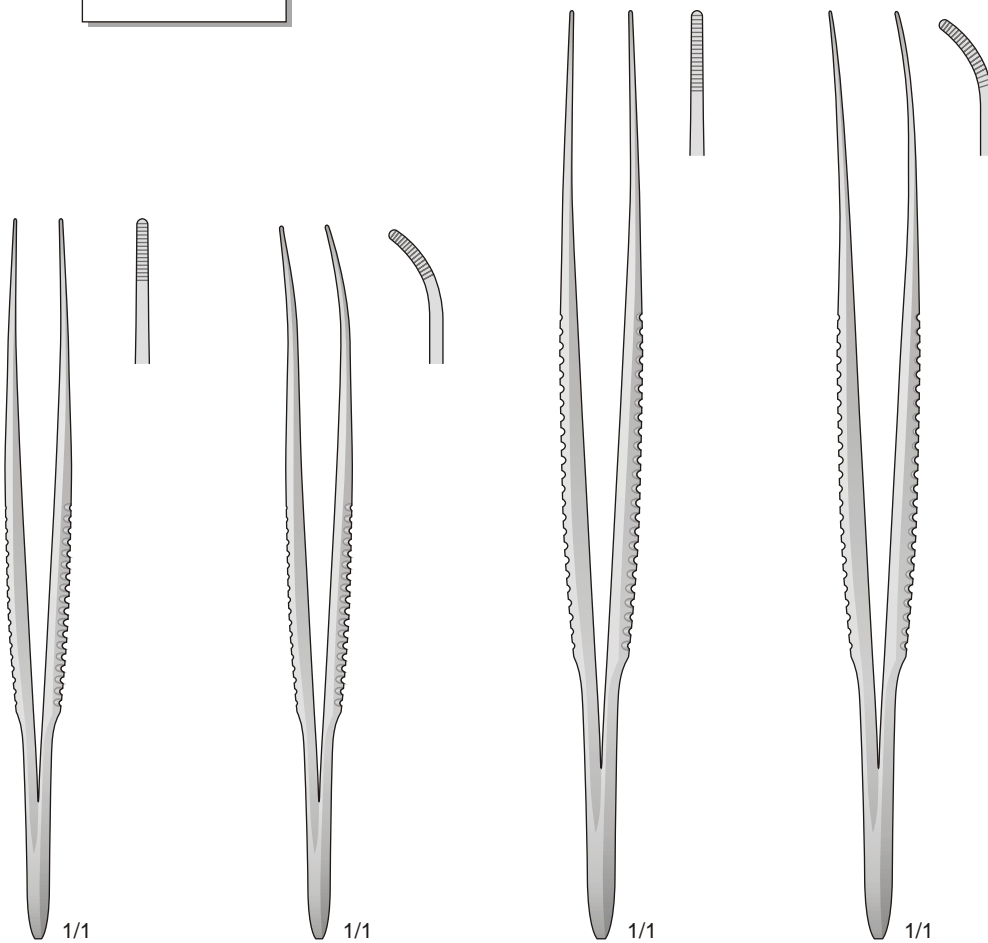
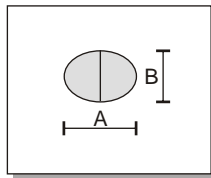

A	B				
0,5	0,4	14-1280-01	14-1290-01	14-1300-01	14-1310-01
0,6	0,5	14-1280-02	14-1290-02	14-1300-02	14-1310-02
0,9	0,7	14-1280-03	14-1290-03	14-1300-03	14-1310-03
1,3	1	14-1280-04	14-1290-04	14-1300-04	14-1310-04
1,6	1,3	14-1280-05	14-1290-05	14-1300-05	14-1310-05
		95 mm	95 mm	125 mm	125 mm

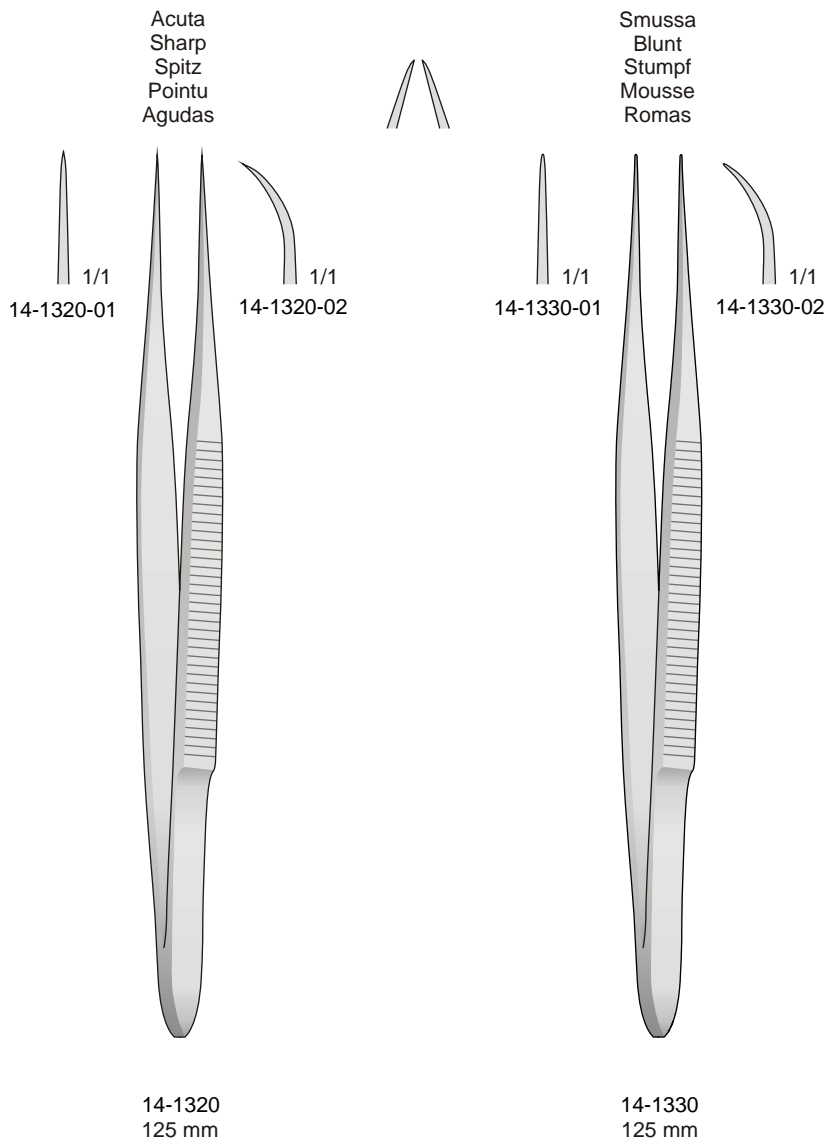

Acuta  
Sharp  
Spitz  
Pointu  
Agudas

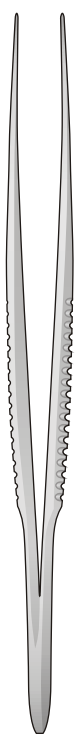

14-1340  
95 mm

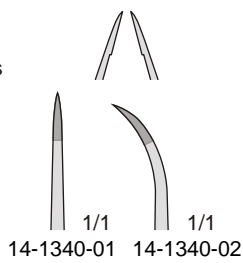

Smussa  
Blunt  
Stumpf  
Mousse  
Romas

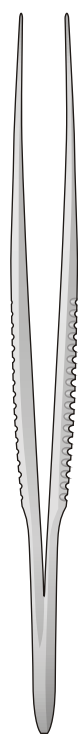

14-1350  
95 mm

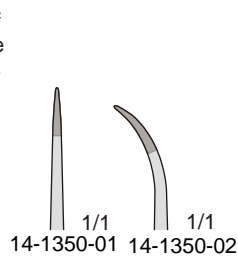

Acuta  
Sharp  
Spitz  
Pointu  
Agudas

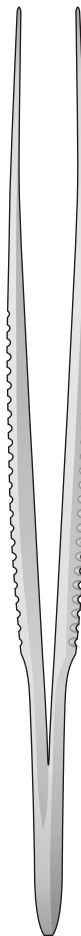

14-1360  
125 mm

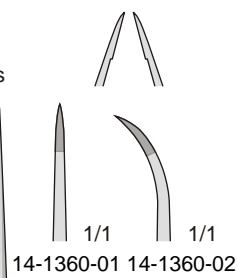

Smussa  
Blunt  
Stumpf  
Mousse  
Romas



14-1370  
125 mm

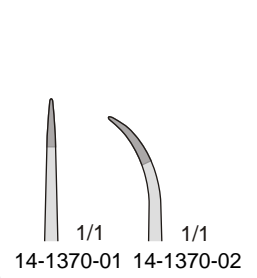

Set microchirurgia oftalmica

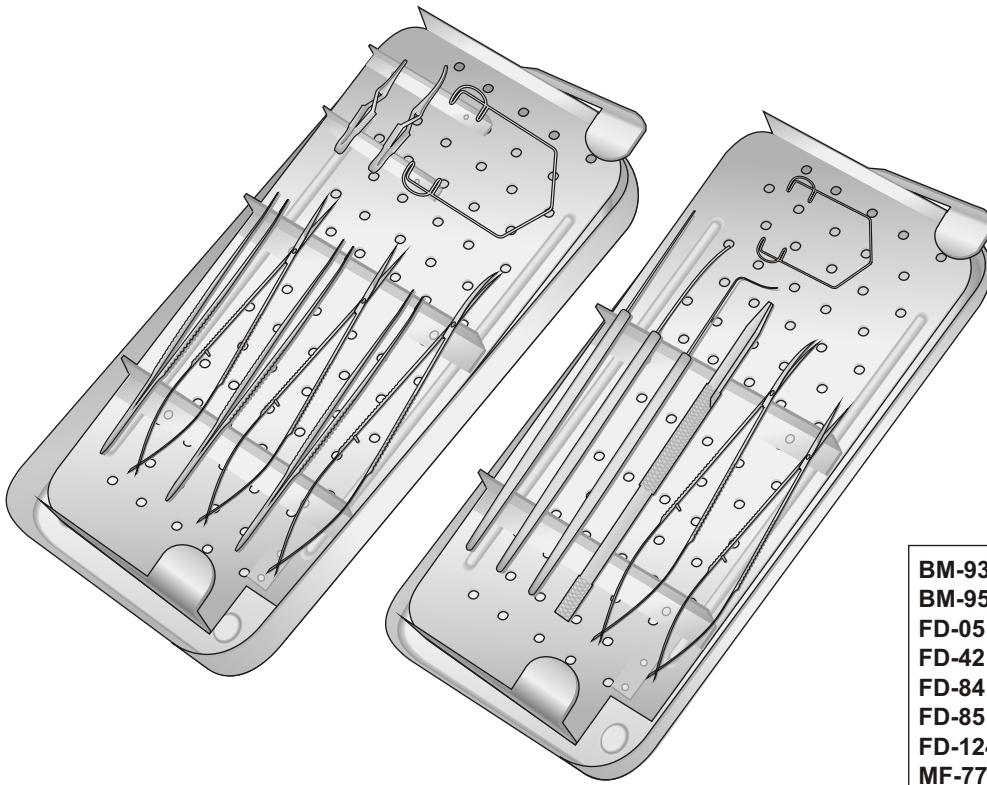

Consisting

- BM-93** - Bulldog diritta cm. 4
- BM-95** - Bulldog diritta cm. 4,5
- FD-05** - Micro forbice curva cm. 11
- FD-42** - Micro forbice curva cm. 12
- FD-84** - Micro pinzetta diritta cm. 11
- FD-85** - Micro pinzetta curva cm. 11
- FD-124** - Micro pinzetta 1x2 denti cm. 11
- MF-77** - Micro pinzetta diritta cm. 9,5
- MF-79** - Micro pinzetta diritta cm. 9,5
- NK-12** - Porta lame per micro cm. 12
- NK-18** - Micro bisturi Graefe cm. 13
- NK-23** - Micro divar. Castrovejo cm. 13
- NK-28** - Micro spatole Wecker cm. 13
- NK-60** - Micro pinzetta Colibri cm. 8
- NK-80** - Blefarostato Barraquer mm. 27x5



Consisting

- BT-16** - Micro divar. Gillies # 2
- DB-21** - Curette Day cm. 16
- FD-54** - Micro forbice curva cm. 16
- FD-135** - Micro forbice diritta cm. 16
- FD-158** - Micro port'aghi dir. cm. 15
- FD-159** - Micro port'aghi curvo cm. 15
- MF-58** - Micro pinzetta 1x2 denti cm. 15
- MF-64** - Micro pinzetta 1x2 denti cm. 15
- MF-93** - Micro pinzetta diritta cm. 15
- MF-94** - Micro pinzetta curva cm. 15

Set microchirurgia oftalmica

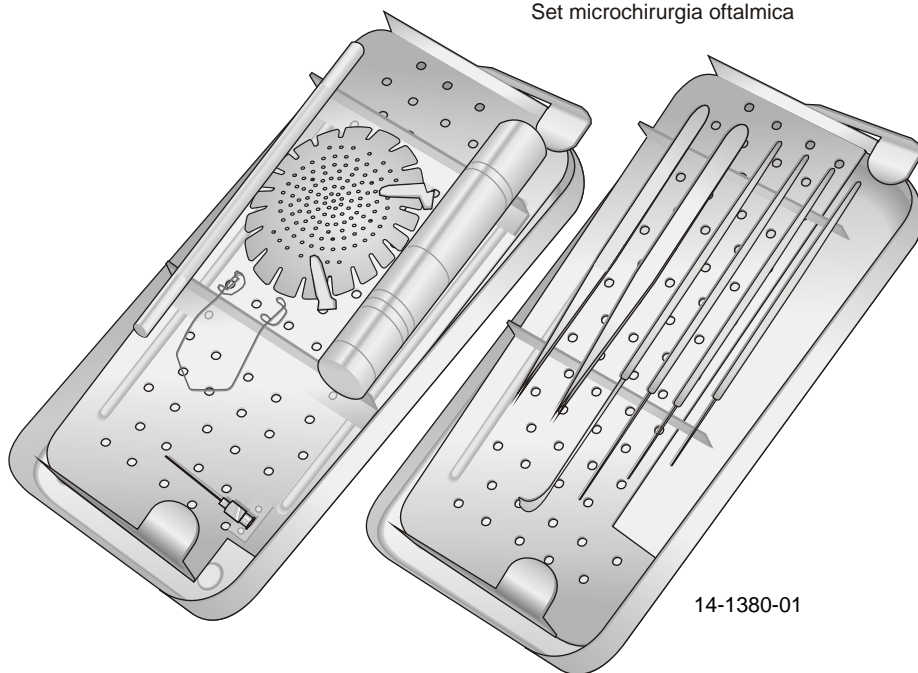

14-1380-01

14-1380  
Consisting

- Micro pinzetta cm. 12
- Div. Desmarres mm. 10
- Micro pinzetta cm. 8,5
- Bisturi Ellis cm. 12
- Spatola Kimura cm. 15
- Blefarostato Barraquer mm.27
- Dilatore Wilder #1
- Pseudo sfera piombo
- Occlusore alluminio mm. 75

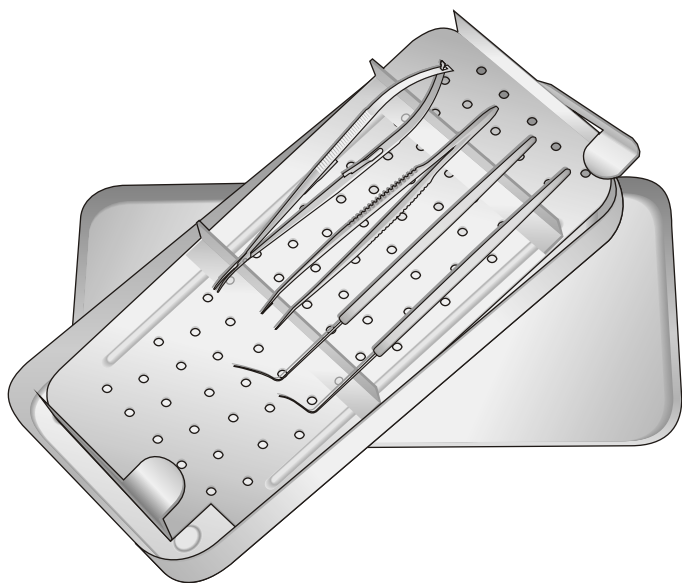

14-1390-01

14-1390  
Consisting

- Micro pinzetta cm. 12
- Micro pinzetta cm. 11
- Micro divaricatore mm. 0,2
- Uncino angolato cm. 13

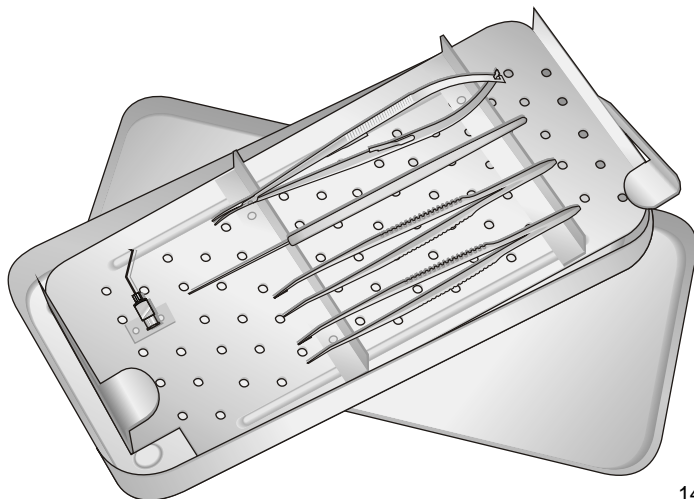

14-1400-01

14-1400  
Consisting

- Micro pinzetta 1x2 denti cm. 9,5
- Micro pinzetta McPerson cm. 9,5
- Micro pinzetta cristallino cm. 11
- Micro spatola mm. 0,2
- Ago lacrimale curvo mm. 35



Set microchirurgia oftalmica

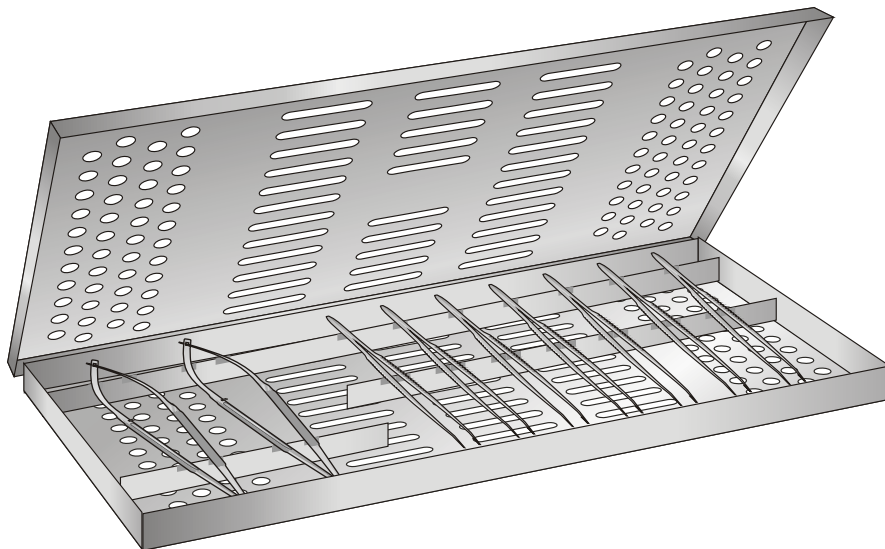

14-1410-01

14-1410  
Consisting

- Micro pinzetta 1x2 denti cm. 9,5
- Micro pinzetta McPherson cm. 9,5
- Micro pinzetta cristallino cm. 11
- Micro pinzetta angolata cm. 11
- Micro pinzetta 1x2 denti cm. 9,5
- Micro pinzetta 1x2 denti cm. 9,5
- Micro pinzetta diritta cm. 9,5
- Micro pinzetta curva cm. 9,5
- Micro pinzetta Colibri cm. 9,5

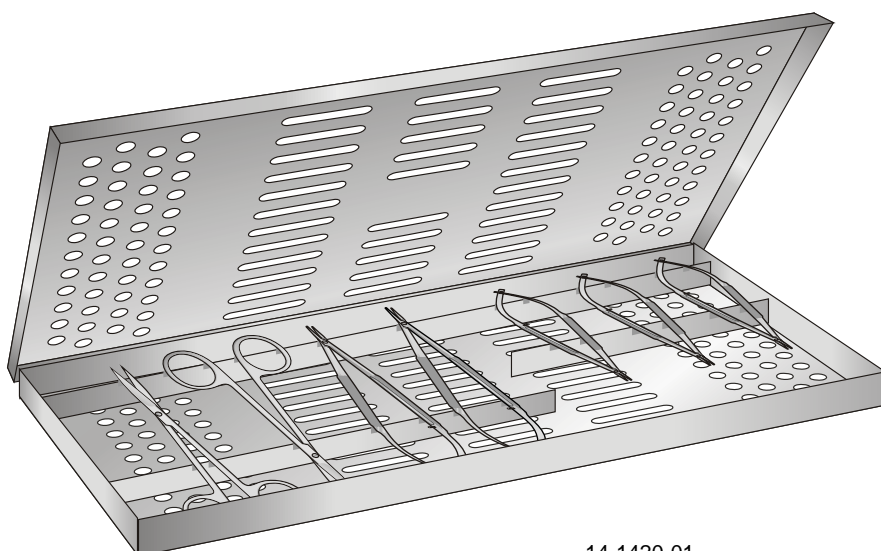

14-1420-01

14-1420  
Consisting

- Micro forbice Troutmann dx. cm. 11
- Micro forbice Troutmann sx. cm. 11
- Micro forbice Vannas cm. 8,5
- Micro forbice Vannas cm. 8,5
- Micro forbice Vannas cm. 8,5
- Forbice Iris diritta cm. 11
- Forbice Iris curva cm. 11



Set microchirurgia oftalmica

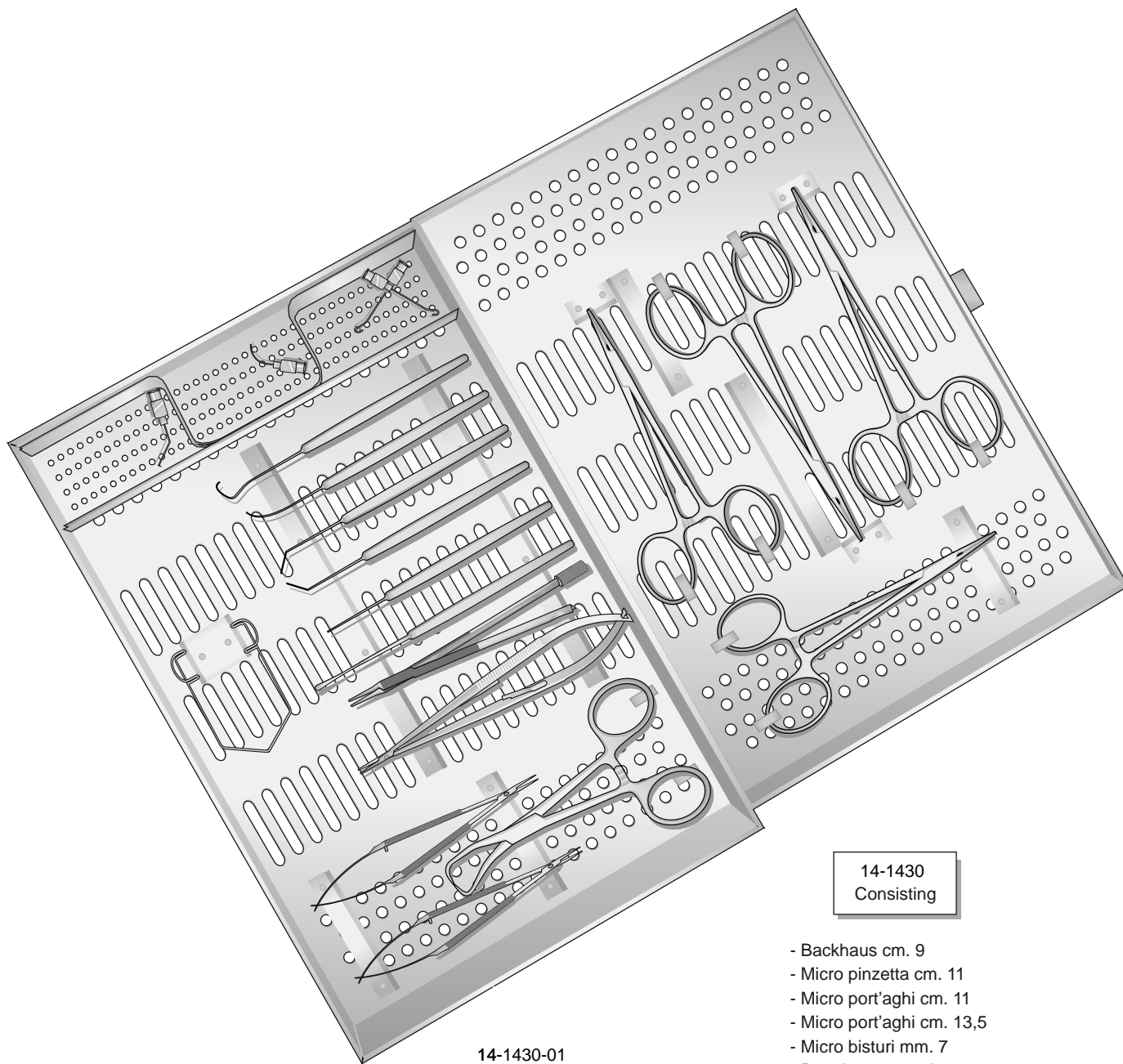

14-1430-01

14-1430  
Consisting

- Backhaus cm. 9
- Micro pinzetta cm. 11
- Micro port'aghi cm. 11
- Micro port'aghi cm. 13,5
- Micro bisturi mm. 7
- Portalame per micro cm. 12
- Micro divaricatore Snellen cm. 12
- Uncino Arruga cm. 14
- Blefarostato Barraquer mm. 42x12
- Micro spatola mm. 0,2
- Micro spatola mm. 0,6
- Micro spatola mm. 1
- Ago lacrimale curvo mm. 30
- Ago lacrimale 15° Sx.
- Ago lacrimale 15° Dx.
- Ago lacrimale curvo mm. 35
- Halstead diritta cm. 12,5
- Pinza Anat. Diritta cm. 14