

MALLET | OSTEOTOME | BONE CHISEL

Hämmer | Osteotom | Knochenmeißel

Maillet | Ostéotome | Burin à os

Martillo | Osteotomo | Cincel para hueso

Martello | Osteotomo | Scalpello per osso



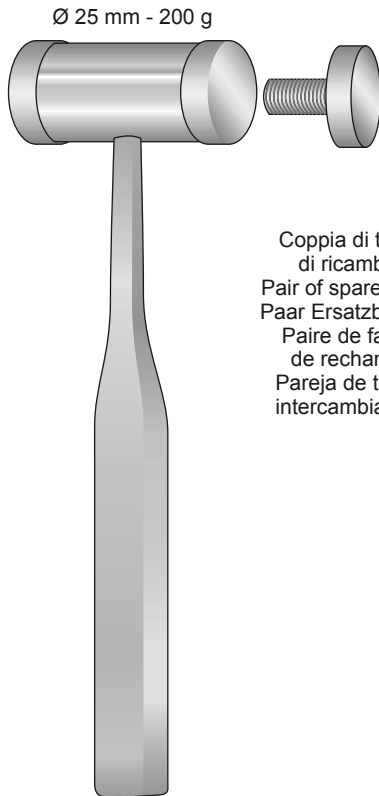

Coppia di teste di ricambio
Pair of spare faces
Paar Ersatzbacken
Paire de faces de rechange
Pareja de tapas intercambiables

MEAD
11-100-01
200 mm

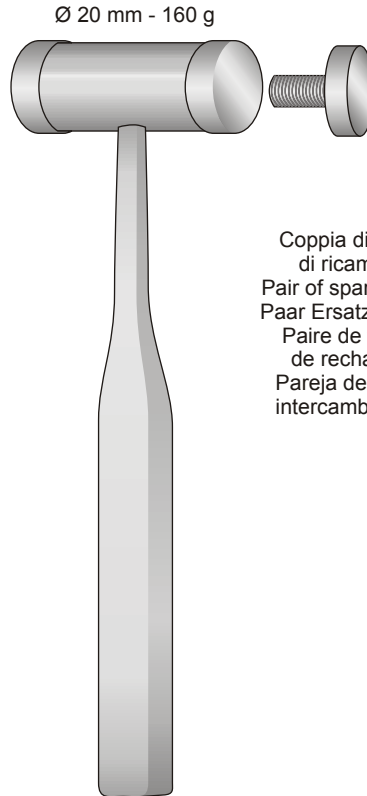

Coppia di teste di ricambio
Pair of spare faces
Paar Ersatzbacken
Paire de faces de rechange
Pareja de tapas intercambiables

MEAD
11-100-02
190 mm

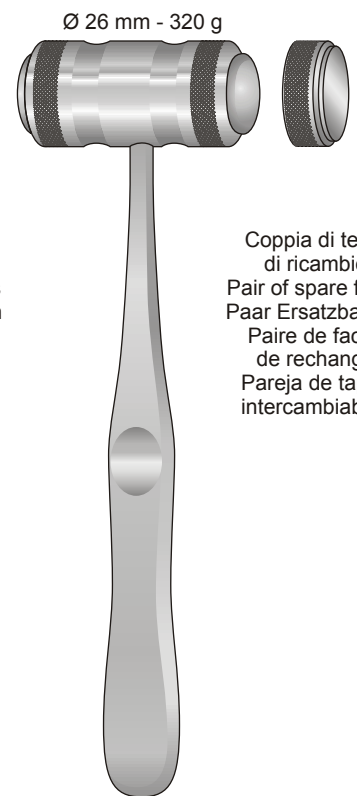

Coppia di teste di ricambio
Pair of spare faces
Paar Ersatzbacken
Paire de faces de rechange
Pareja de tapas intercambiables

MEAD
11-110-19
190 mm

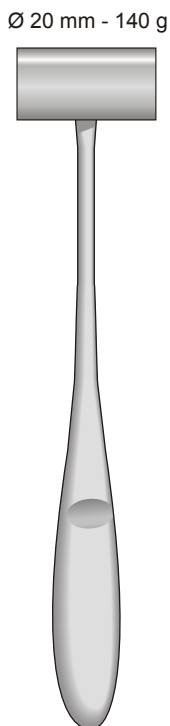

11-120-16
165 mm

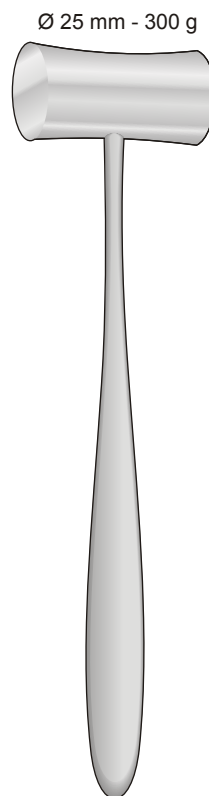

LUCAE
11-130-19
190 mm

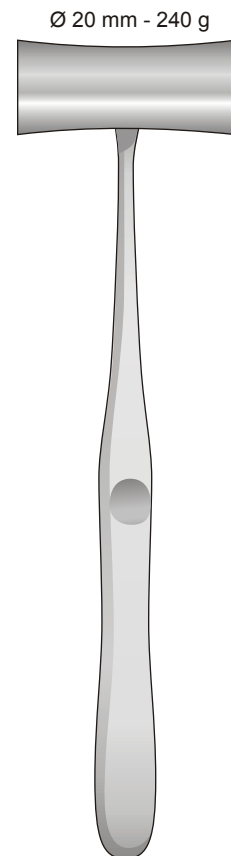

WILLIGER
11-140-24
240 mm

1 Lato piatto - 1 Lato convesso
1 Side flat - 1 Side convex
1 Seite flach - 1 Seite convex
1 Face plate - 1 Face convexe
1 Parte plana - 1 Parte convexe

Ø 30 mm - 240 g

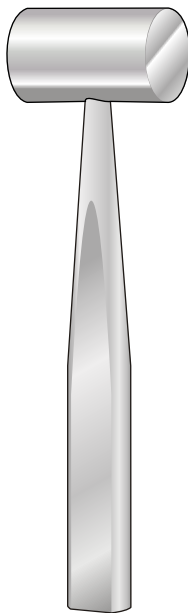

COTTLE
11-150-18
185 mm

Ø 30 mm - 300 g

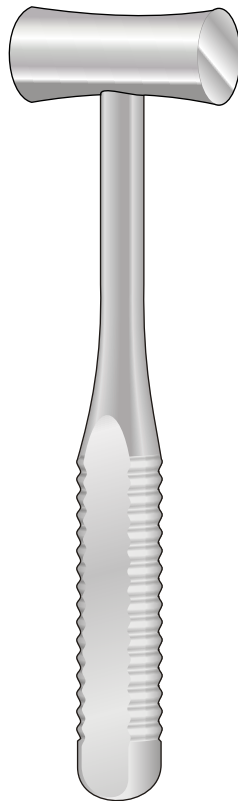

BERGMANN
11-160-23
235 mm

Ø 45 mm - 300 g

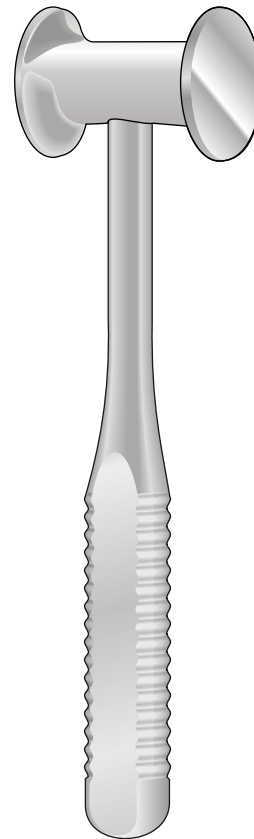

BERGMANN
11-170-24
245 mm

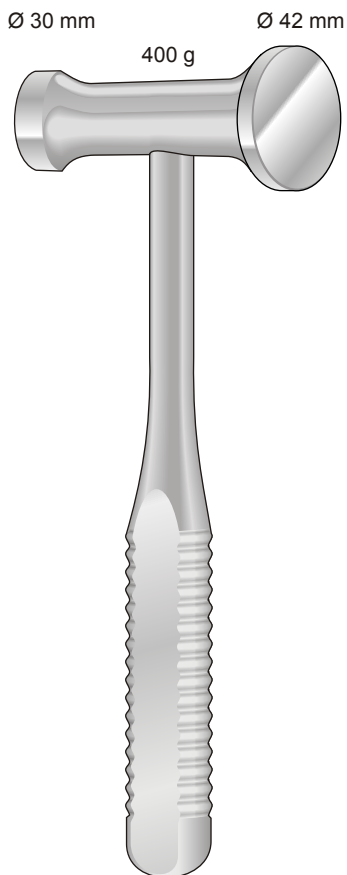

11-180-24
240 mm

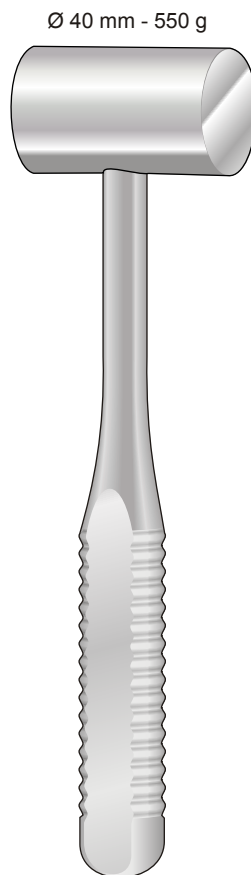

OMBREDANNE
11-190-24
240 mm

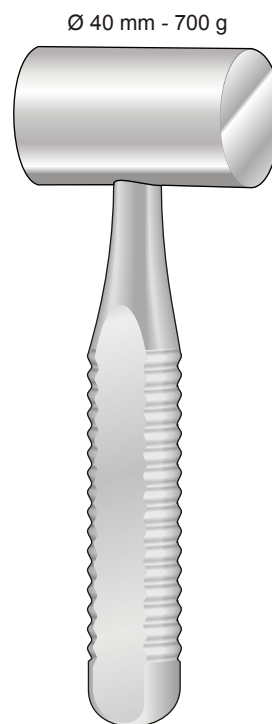

HEAT
11-200-18
185 mm

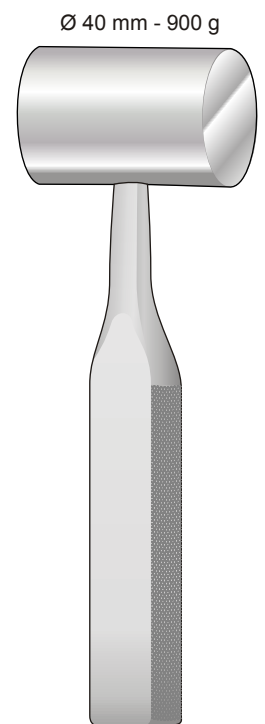

11-210-19
190 mm

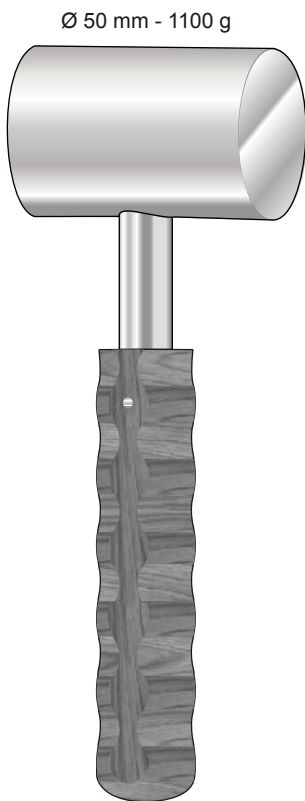

11-220-20
200 mm

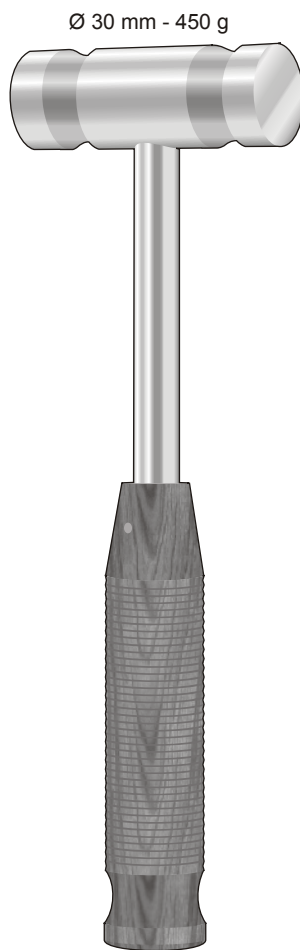

11-230-26
260 mm

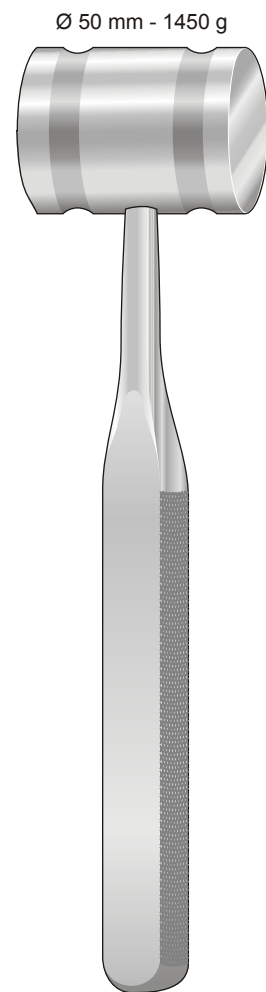



11-240-27
270 mm



-  11-250-01
Ø3 mm
-  11-250-02
Ø5 mm
-  11-250-03
Ø8 mm

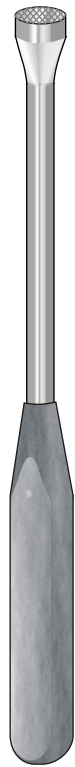

CASPAR
11-250
200 mm

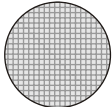
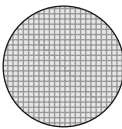

-  11-260-01
Ø12 mm
-  11-260-02
Ø14 mm
-  11-260-03
Ø16 mm

11-260
200 mm

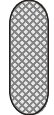
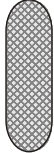

-  11-270-01
3x8 mm
-  11-270-02
4x10 mm
-  11-270-03
5x15 mm
-  11-270-04
6x20 mm

SYPERT
11-270
290 mm

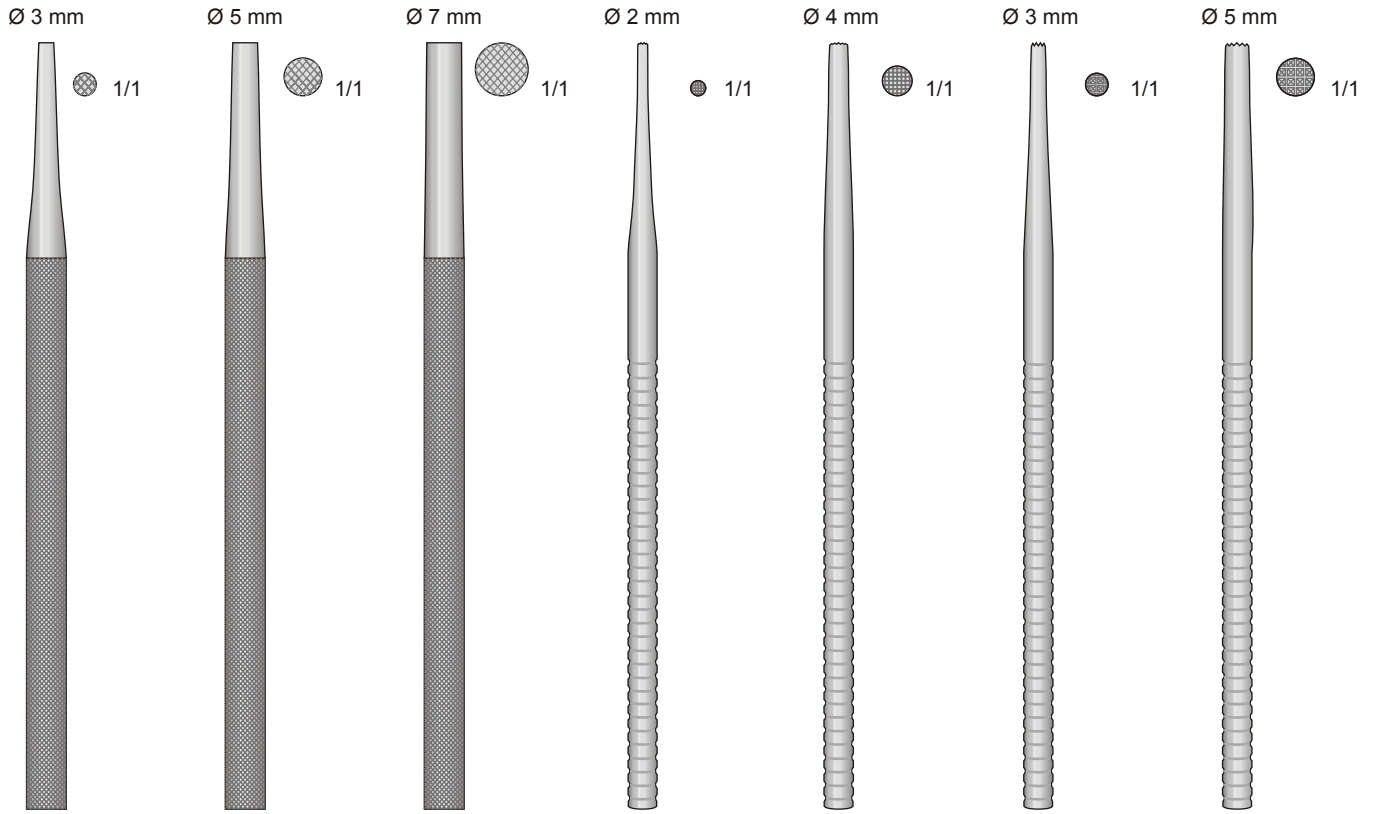

11-280-01 155 mm 11-280-02 155 mm 11-280-03 155 mm 11-290-01 155 mm 11-290-02 155 mm 11-290-03 155 mm 11-290-04 155 mm

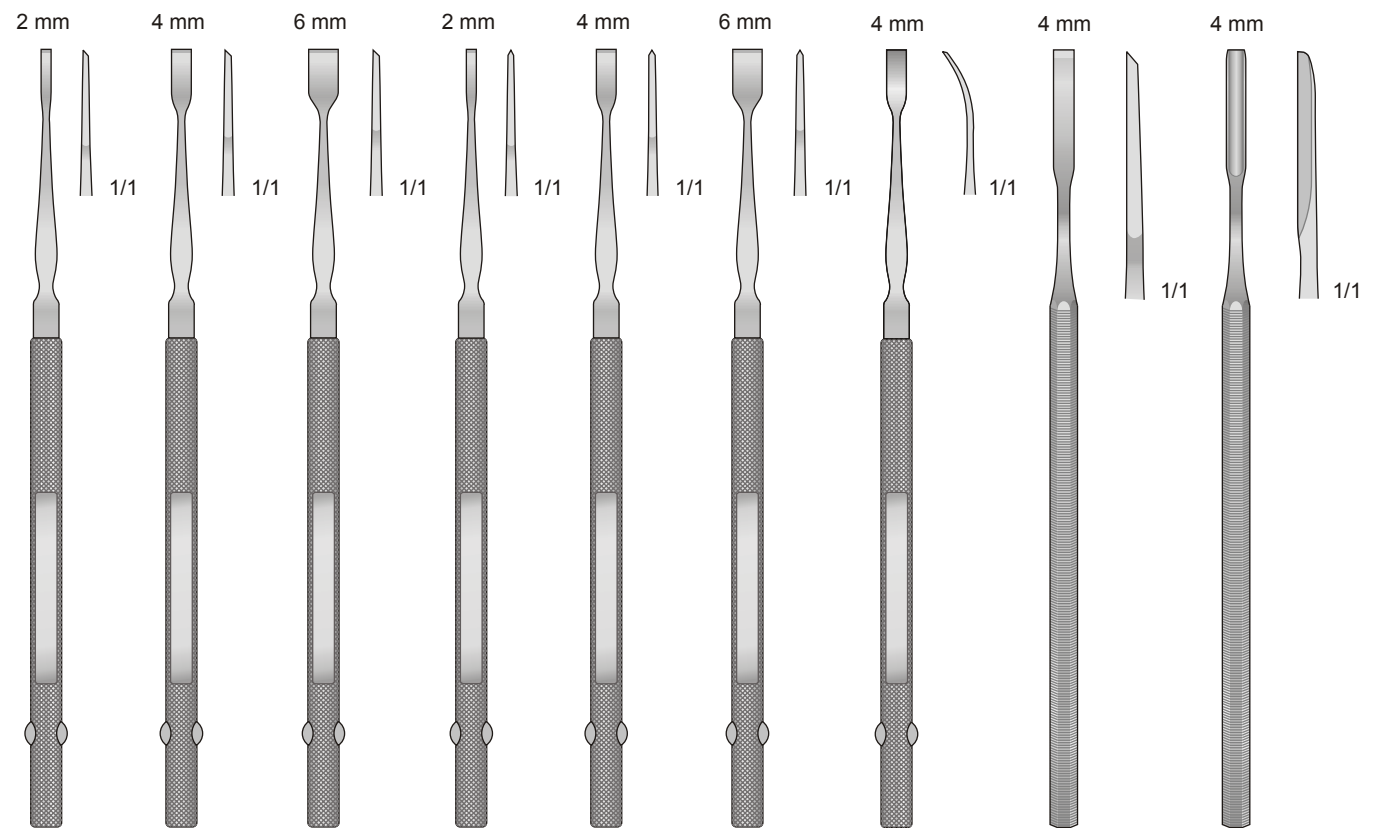

11-300-01 160 mm 11-300-02 160 mm 11-300-03 160 mm 11-300-04 160 mm 11-300-05 160 mm 11-300-06 160 mm FREER 11-310-16 160 mm BUCKLEY 11-320-16 160 mm BUCKLEY 11-330-16 160 mm

Osteotomi - Osteotomes
Osteotome - Ostéotomes - Osteótomos

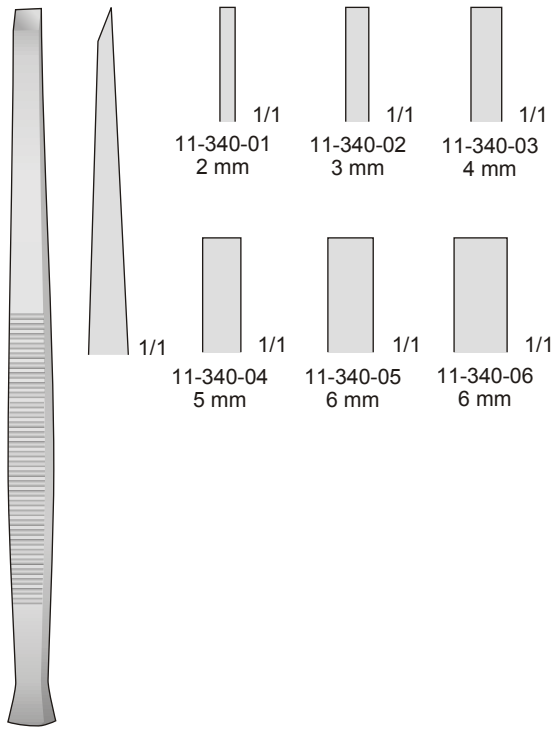

PARTSCH
11-340
140 mm

Sgorbie - Gouges
Hohlmeissel - Gouges - Gubias

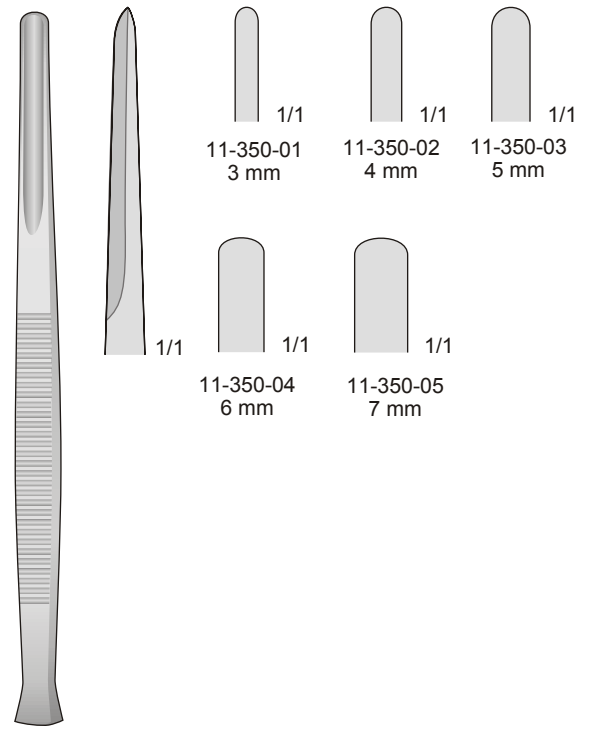

PARTSCH
11-350
140 mm

Osteotomi - Osteotomes
Osteotome - Ostéotomes - Osteótomos

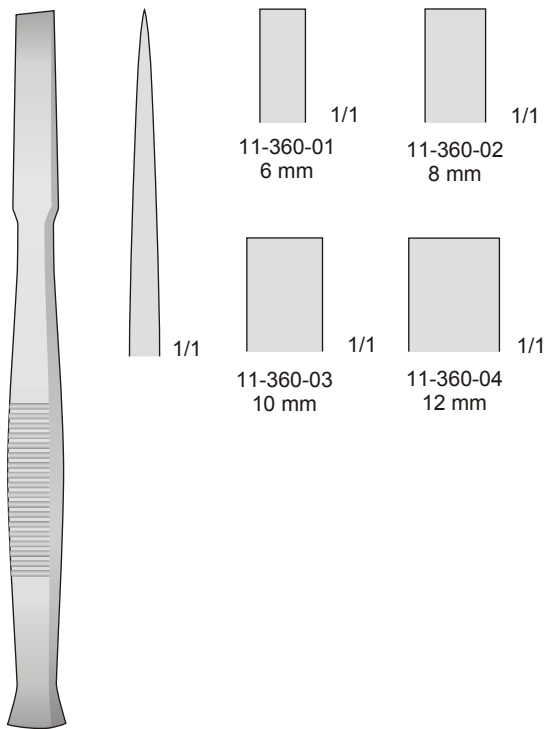

11-360
140 mm

Sgorbie - Gouges
Hohlmeissel - Gouges - Gubias

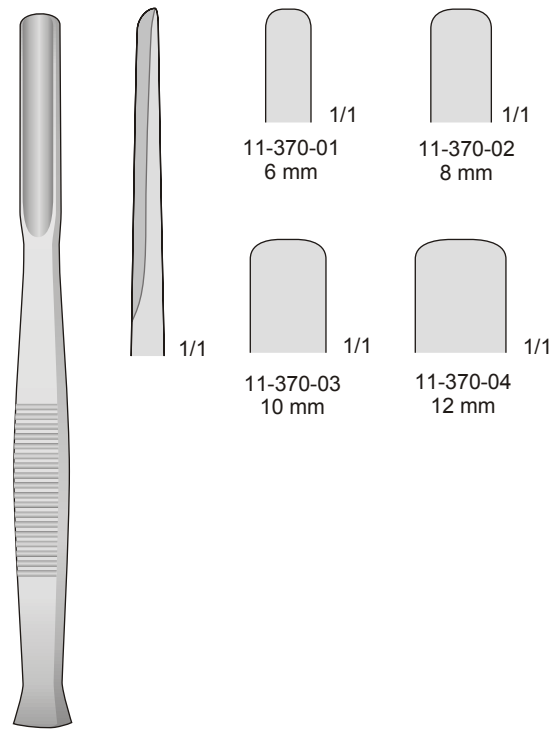

11-370
140 mm

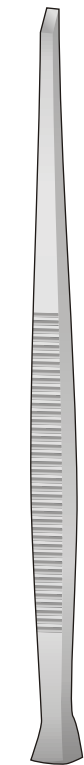
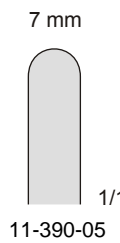
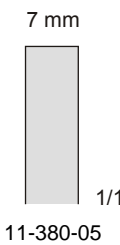
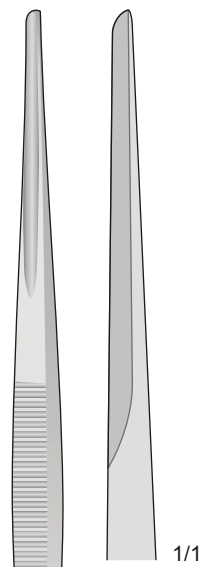
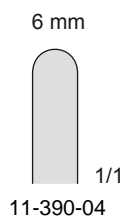
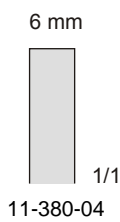
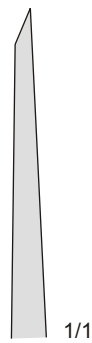
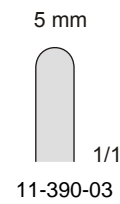
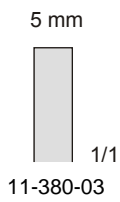
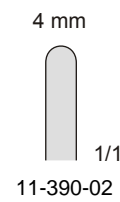
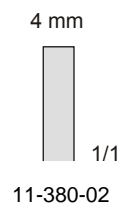
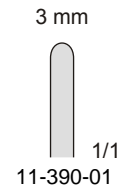
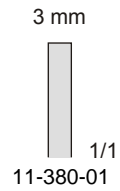

PARTSCH
11-380
170 mm

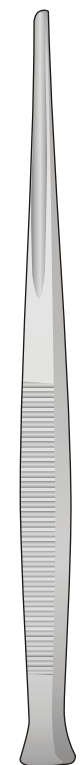

PARTSCH
11-390
170 mm

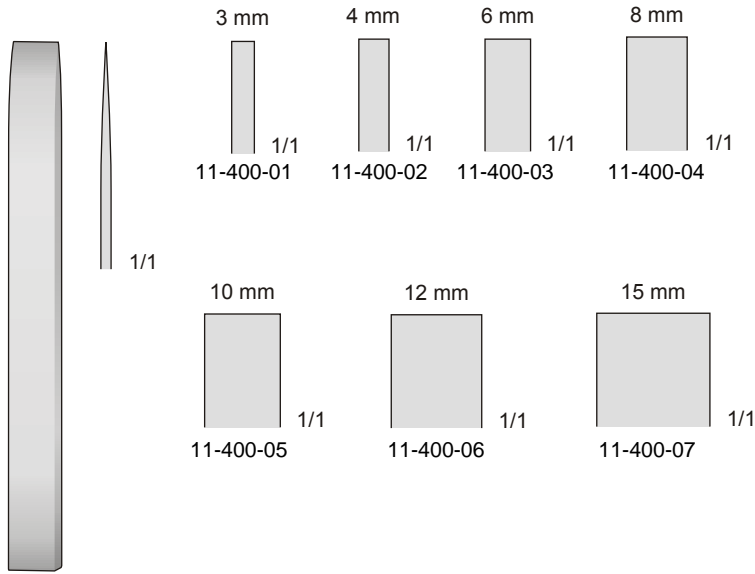

MINI-LAMBOTTE
11-400
125 mm



LAMBOTTE
11-410
250 mm

LAMBOTTE
11-420
250 mm

OBWEGESER
11-430
235 mm

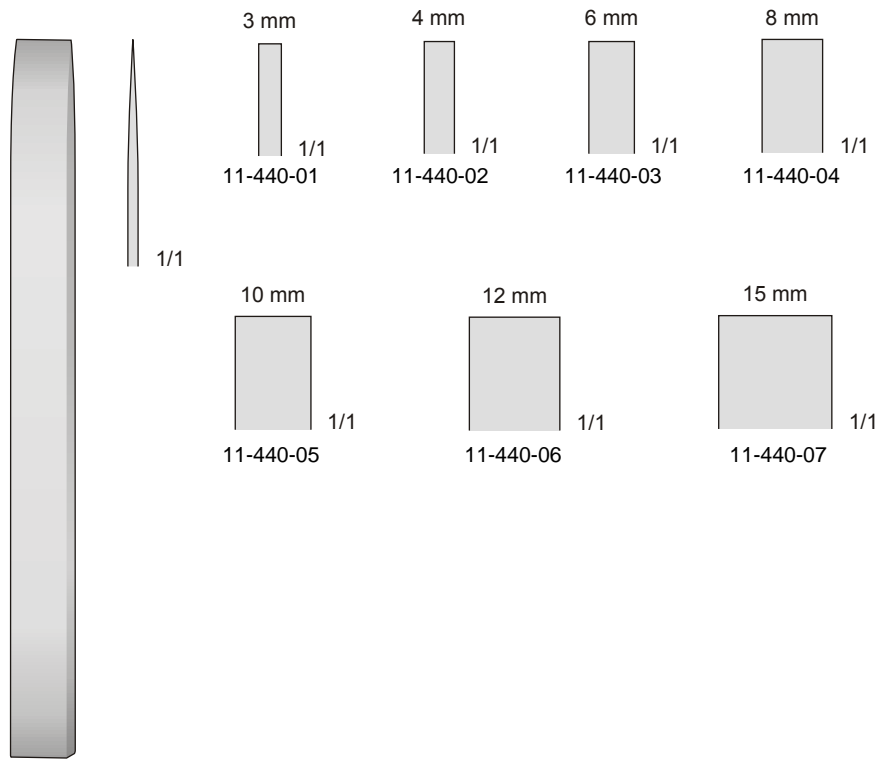

MINI-LAMBOTTE
11-440
170 mm

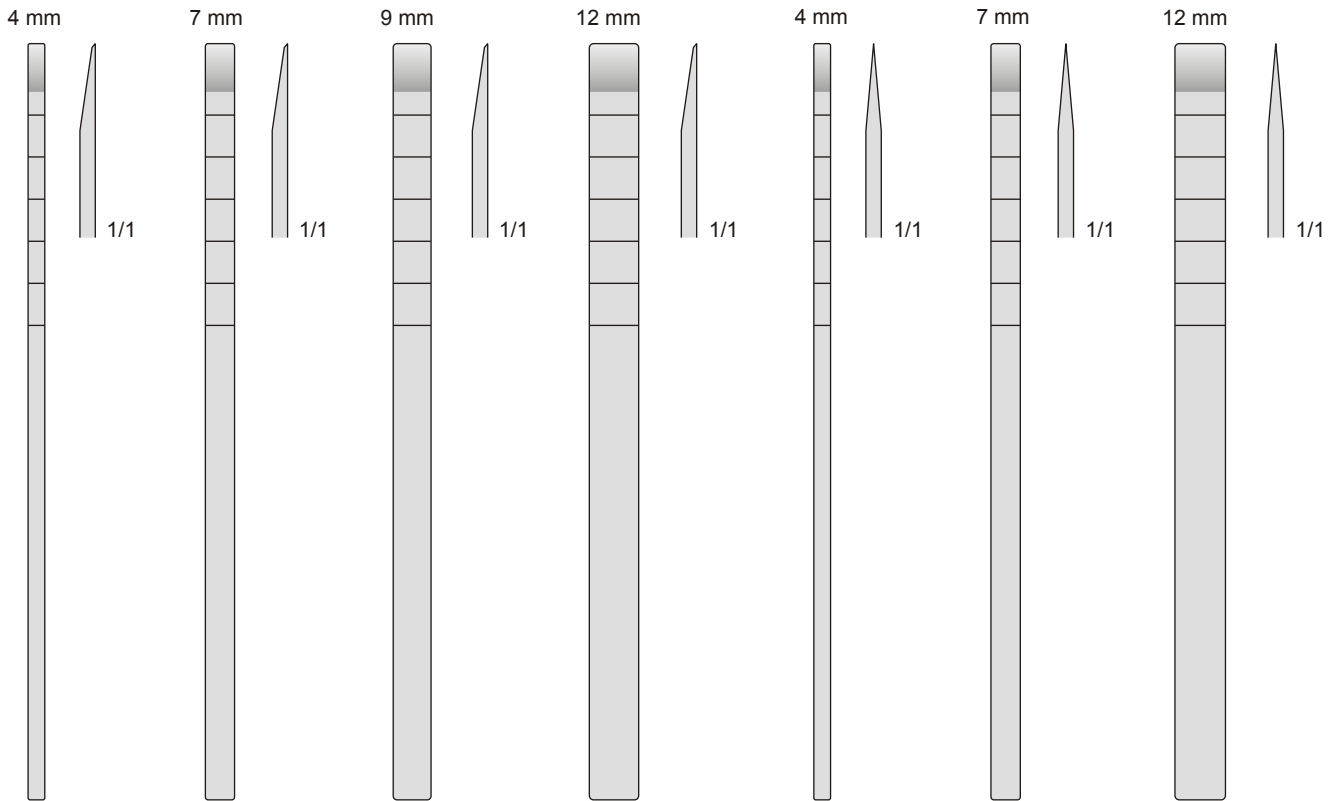

COTTLE
11-450-01
180 mm

COTTLE
11-450-02
180 mm

COTTLE
11-450-03
180 mm

COTTLE
11-450-04
180 mm

COTTLE
11-460-01
180 mm

COTTLE
11-460-02
180 mm

COTTLE
11-460-03
180 mm

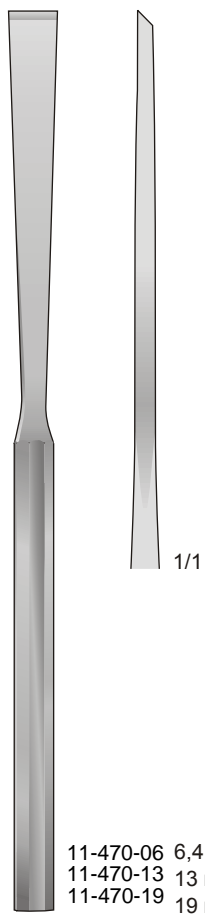

HIBBS
11-470
230 mm

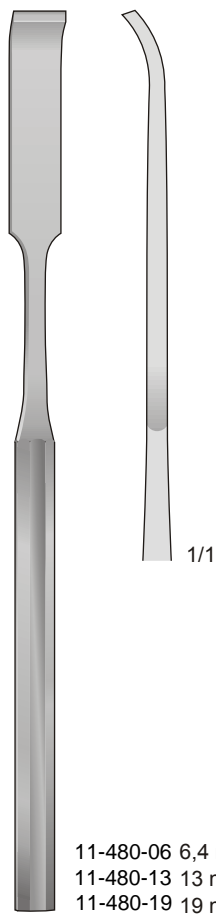

HIBBS
11-480
230 mm

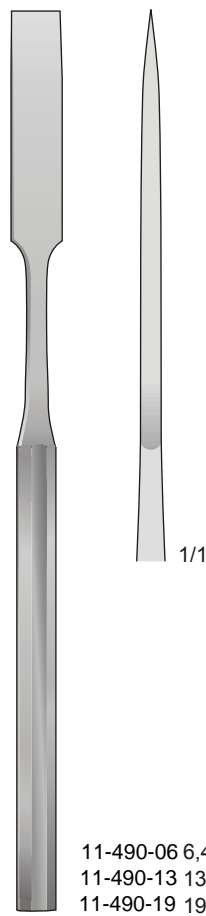

HIBBS
11-490
230 mm

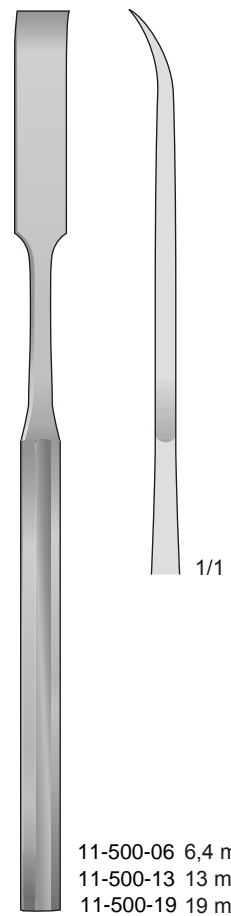

HIBBS
11-500
230 mm



11-510-04 4 mm
11-510-06 6 mm
11-510-08 8 mm

11-510
180 mm



11-520-04 4 mm
11-520-06 6 mm
11-520-08 8 mm

11-520
180 mm



11-530-06 6 mm
11-530-08 8 mm



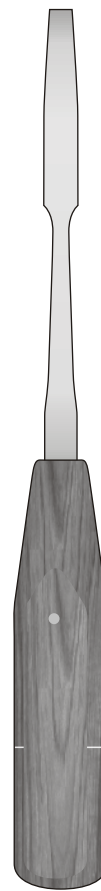



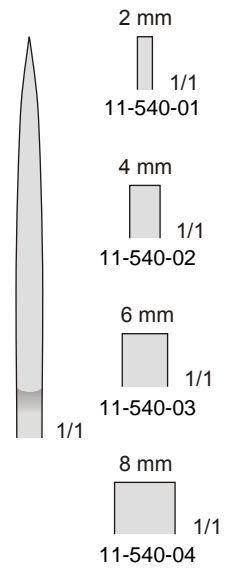

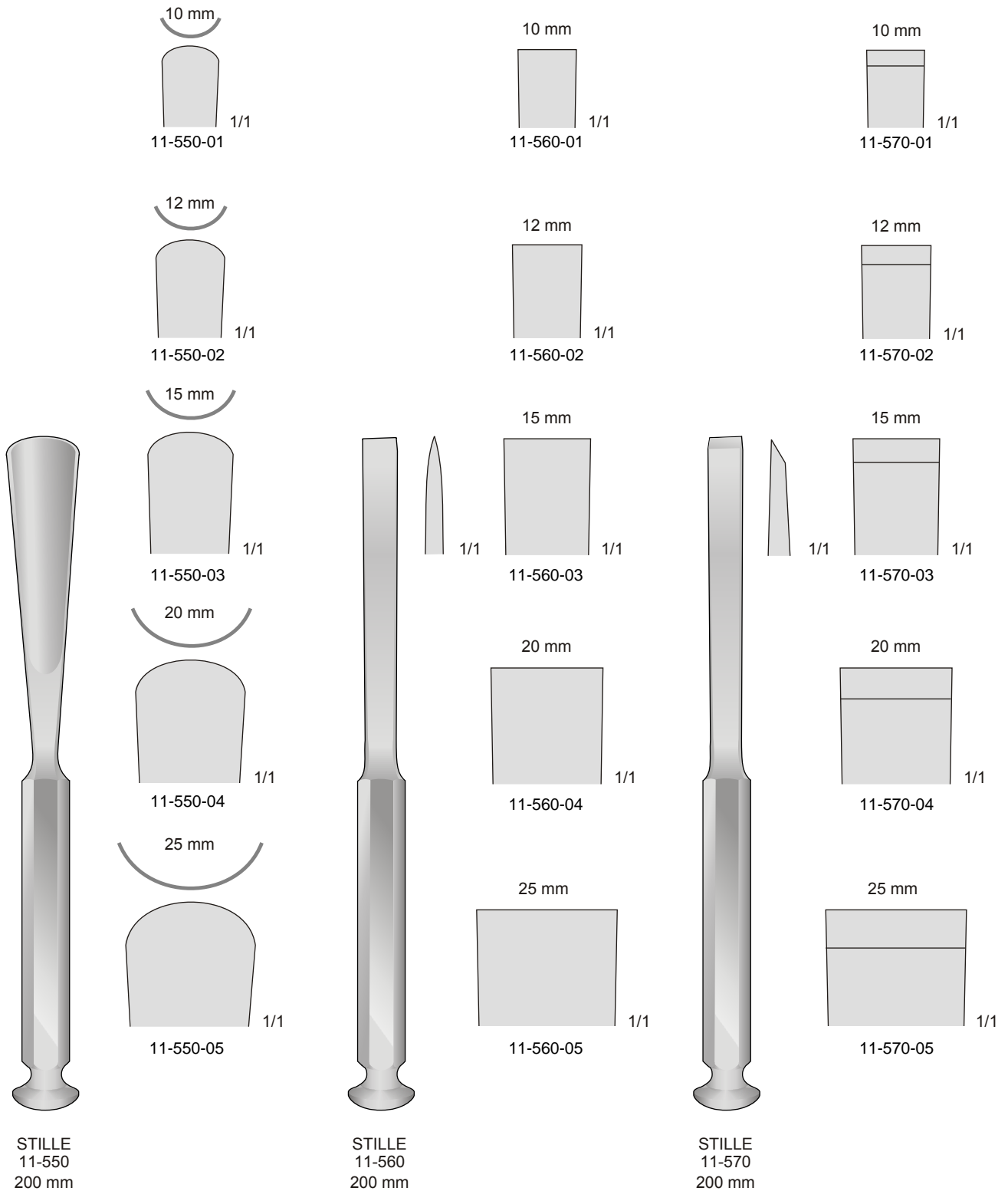



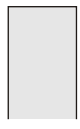





11-530
180 mm

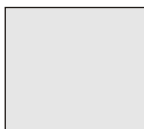

MINI-LEXER
11-540
200 mm



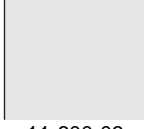

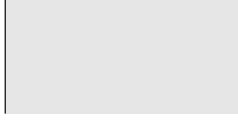
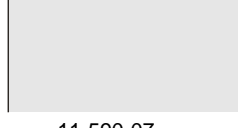
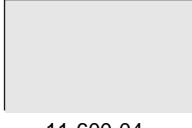
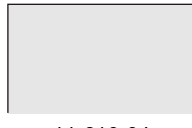
 <p>6 mm 1/1 11-580-01</p>	 <p>6 mm 1/1 11-590-01</p>		
 <p>9 mm 1/1 11-580-02</p>	 <p>9 mm 1/1 11-590-02</p>		
 <p>13 mm 1/1 11-580-03</p>	 <p>13 mm 1/1 11-590-03</p>	 <p>1/1</p>	 <p>1/1</p>
 <p>16 mm 1/1 11-580-04</p>	 <p>16 mm 1/1 11-590-04</p>	 <p>9 mm 1/1 11-600-01</p>	 <p>9 mm 1/1 11-610-01</p>
 <p>19 mm 1/1 11-580-05</p>	 <p>19 mm 1/1 11-590-05</p>	 <p>13 mm 1/1 11-600-02</p>	 <p>13 mm 1/1 11-610-02</p>
 <p>25 mm 1/1 11-580-06</p>	 <p>25 mm 1/1 11-590-06</p>	 <p>19 mm 1/1 11-600-03</p>	 <p>19 mm 1/1 11-610-03</p>
 <p>32 mm 1/1 11-580-07</p>	 <p>32 mm 1/1 11-590-07</p>	 <p>25 mm 1/1 11-600-04</p>	 <p>25 mm 1/1 11-610-04</p>
<p>SMITH-PETERSEN 11-580 200 mm</p>	<p>SMITH-PETERSEN 11-590 200 mm</p>	<p>SMITH-PETERSEN 11-600 200 mm</p>	<p>SMITH-PETERSEN 11-610 200 mm</p>

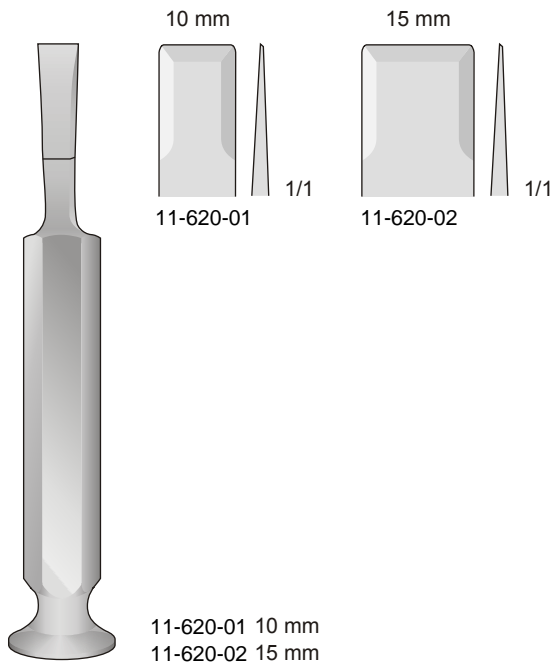

TESSIER
11-620
160 mm

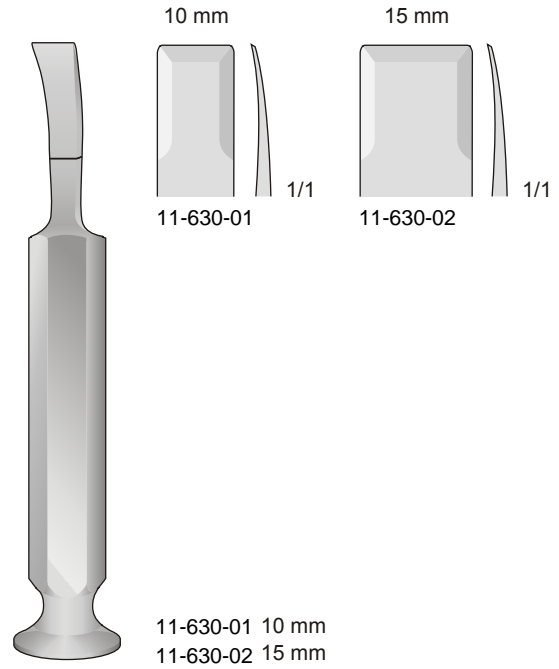

TESSIER
11-630
160 mm

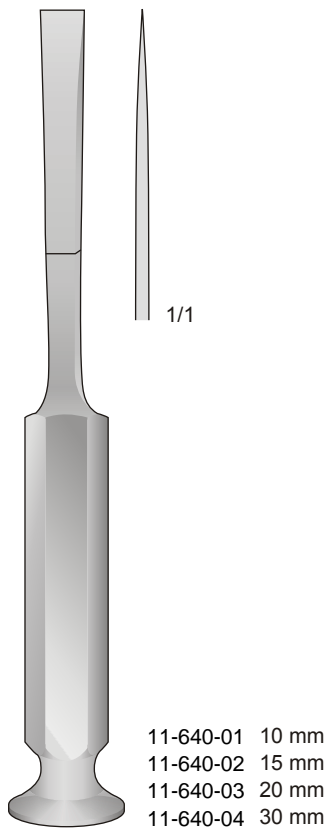

TESSIER
11-640
200 mm

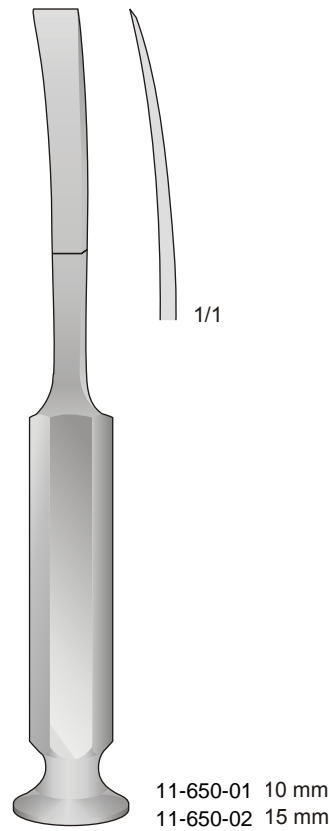

TESSIER
11-650
200 mm

Set completo di Set complete with Komplettsset mit Set complet avec Set completo con		
1 Manico portalamo in ferrozell	4 Lame Fig. 1-2-3-4	1 Chiave ferma lama
1 With Ferrozell handle	4 Blades Fig. 1-2-3-4	-
1 Mit Ferrozellgriff	4 Klingen Fig. 1-2-3-4	-
1 Avec poignée en Ferrozell	4 Lames Fig. 1-2-3-4	-
1 Con mango de Ferrozell	4 Hojas Fig. 1-2-3-4	-

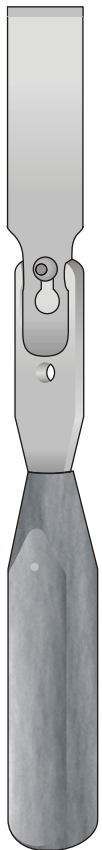

11-660
190 mm

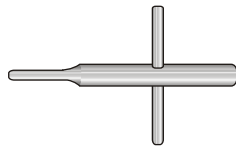

11-670-09
90 mm

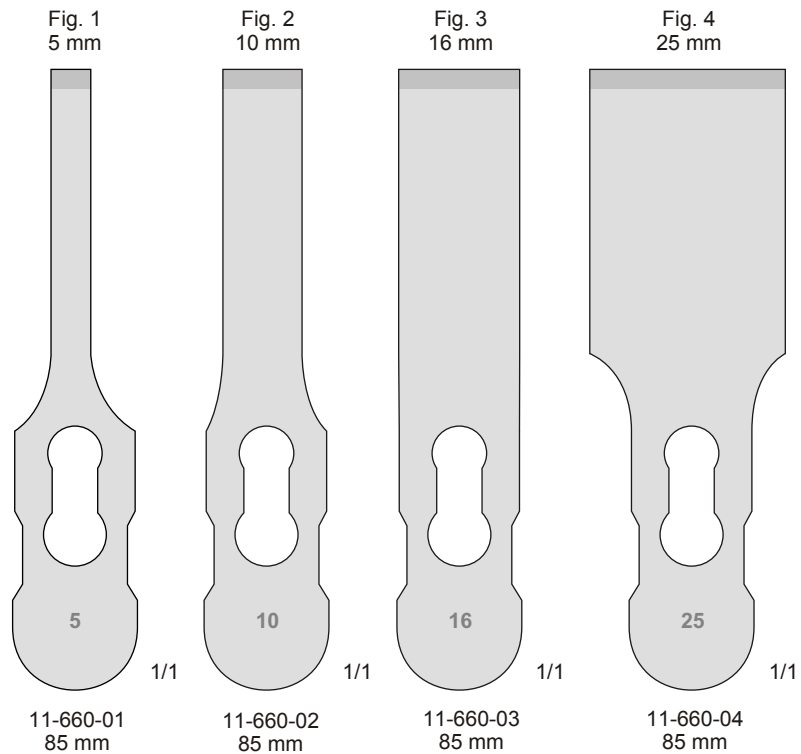

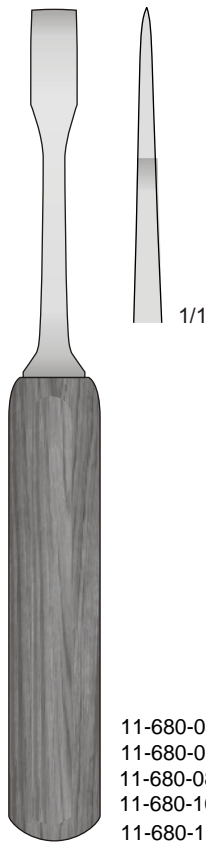

- 11-680-04 4 mm
- 11-680-06 6 mm
- 11-680-08 8 mm
- 11-680-10 10 mm
- 11-680-12 12 mm

MINI-LEXER
11-680
180 mm

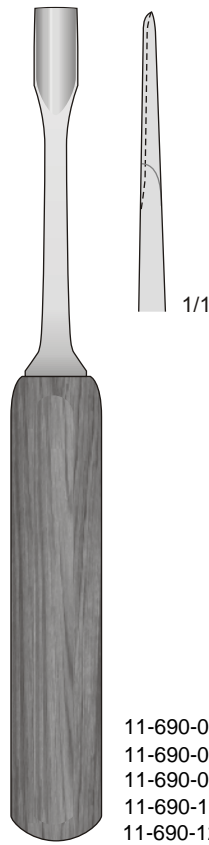

- 11-690-04 4 mm
- 11-690-06 6 mm
- 11-690-08 8 mm
- 11-690-10 10 mm
- 11-690-12 12 mm

MINI-LEXER
11-690
180 mm

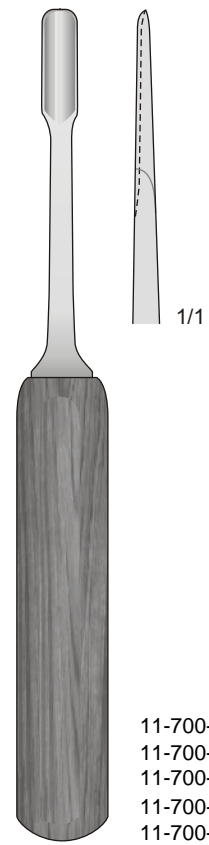

- 11-700-04 4 mm
- 11-700-06 6 mm
- 11-700-08 8 mm
- 11-700-10 10 mm
- 11-700-12 12 mm

LEXER
11-700
180 mm

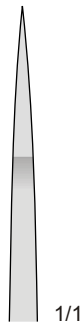

1/1

- 11-710-05 5 mm
- 11-710-07 7 mm
- 11-710-10 10 mm
- 11-710-15 15 mm
- 11-710-20 20 mm
- 11-710-25 25 mm
- 11-710-30 30 mm

LEXER
11-710
220 mm

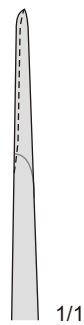

1/1

- 11-720-05 5 mm
- 11-720-07 7 mm
- 11-720-10 10 mm
- 11-720-15 15 mm
- 11-720-20 20 mm
- 11-720-25 25 mm
- 11-720-30 30 mm

LEXER
11-720
220 mm

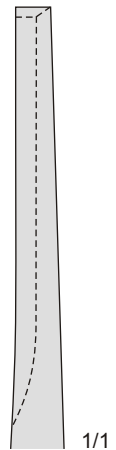

1/1

9 mm

11-730
220 mm



Sgorbie - Gouges
Hohlmeissel - Gouges - Gubias

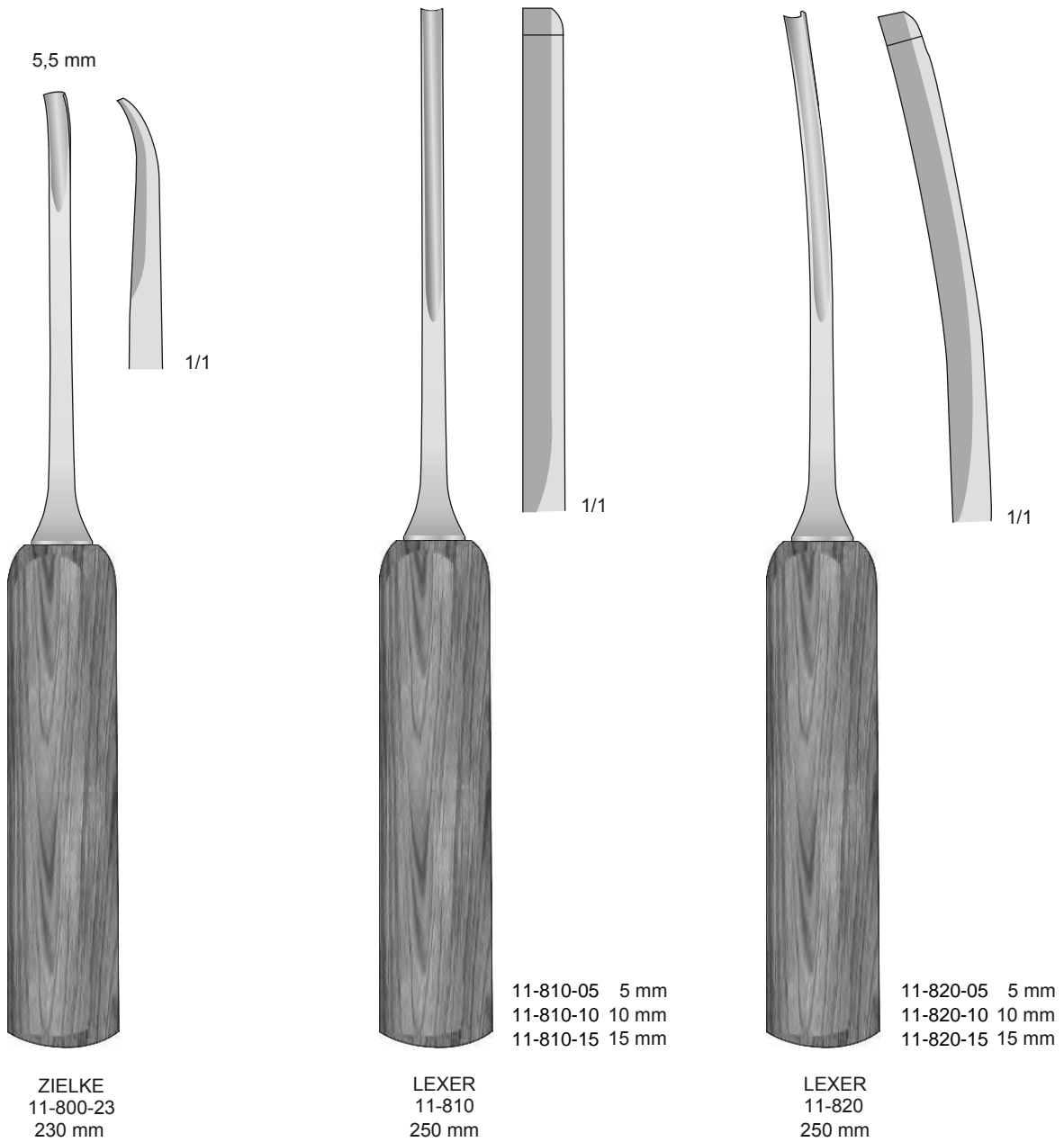

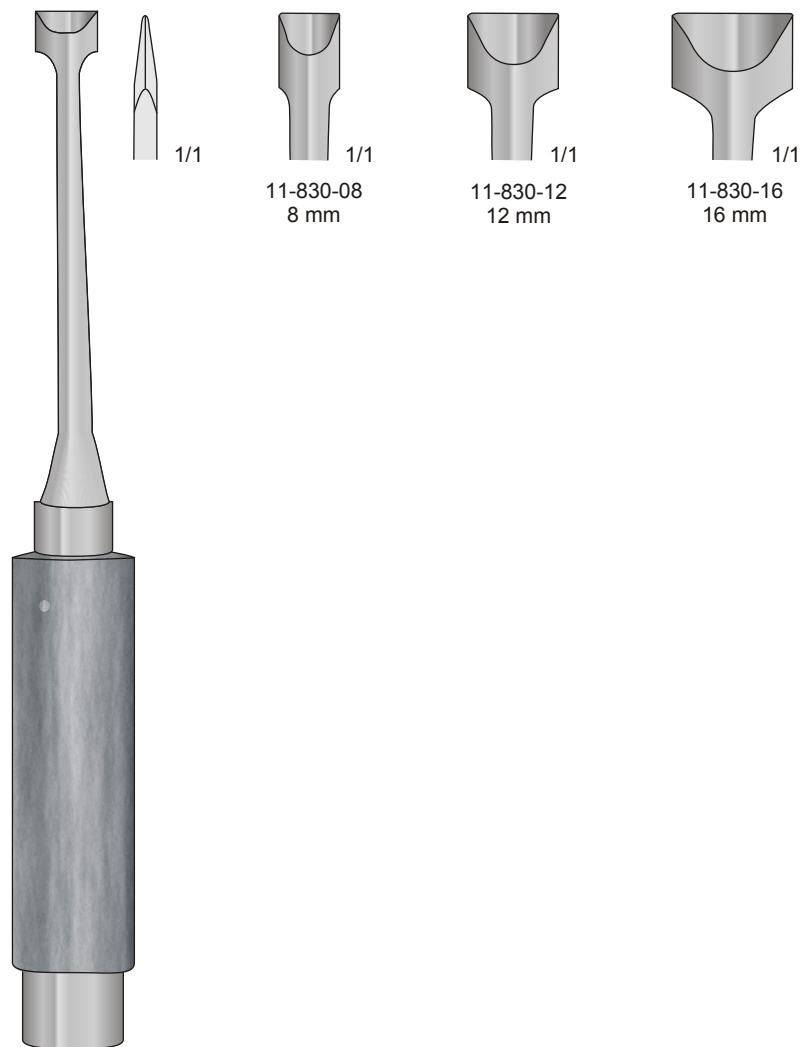

OBWEGESER
11-830
220 mm

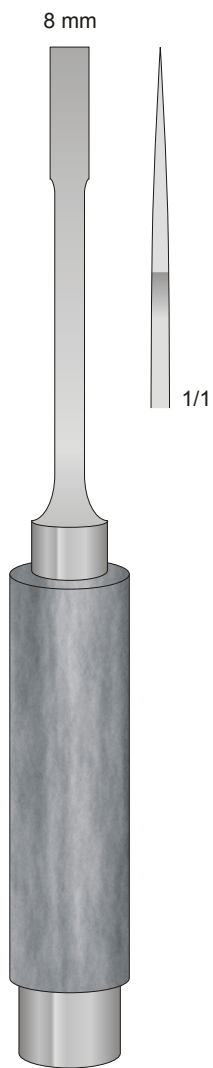

OBWEGESER
11-840-01
220 mm

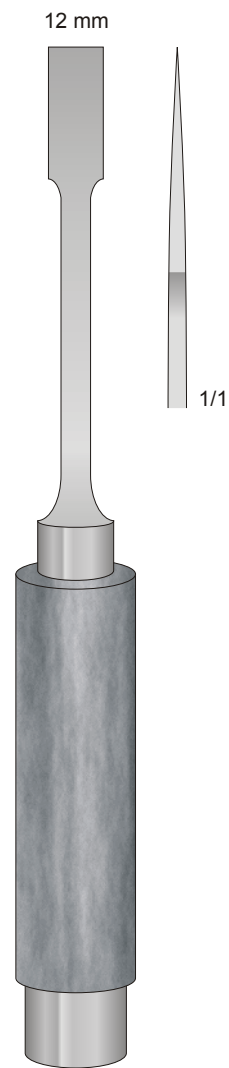

OBWEGESER
11-840-02
220 mm

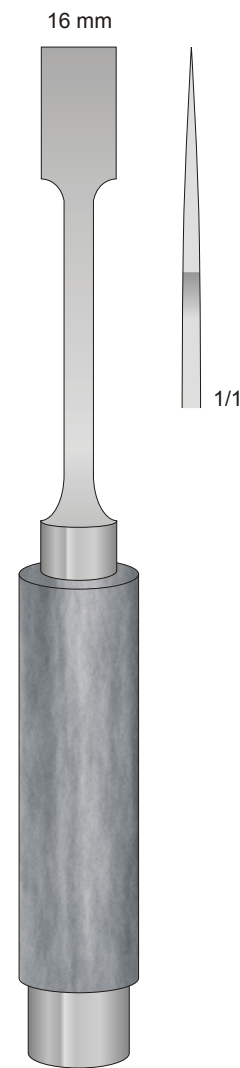

OBWEGESER
11-840-03
220 mm

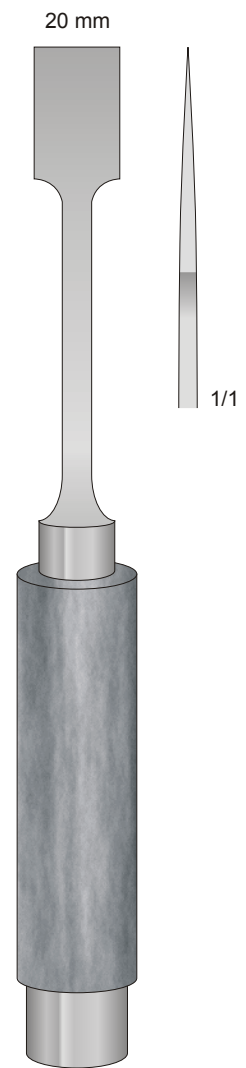

OBWEGESER
11-840-04
220 mm