

HEMOSTATIC FORCEPS | TOWEL CLAMPS

Arterienklemmen

| Tuchklemmen

Pinces hémostatiques

| Pinces à champs

Pinzas hemostáticas

| Pinzas de campo

Pinzette emostatiche

| Fissateli

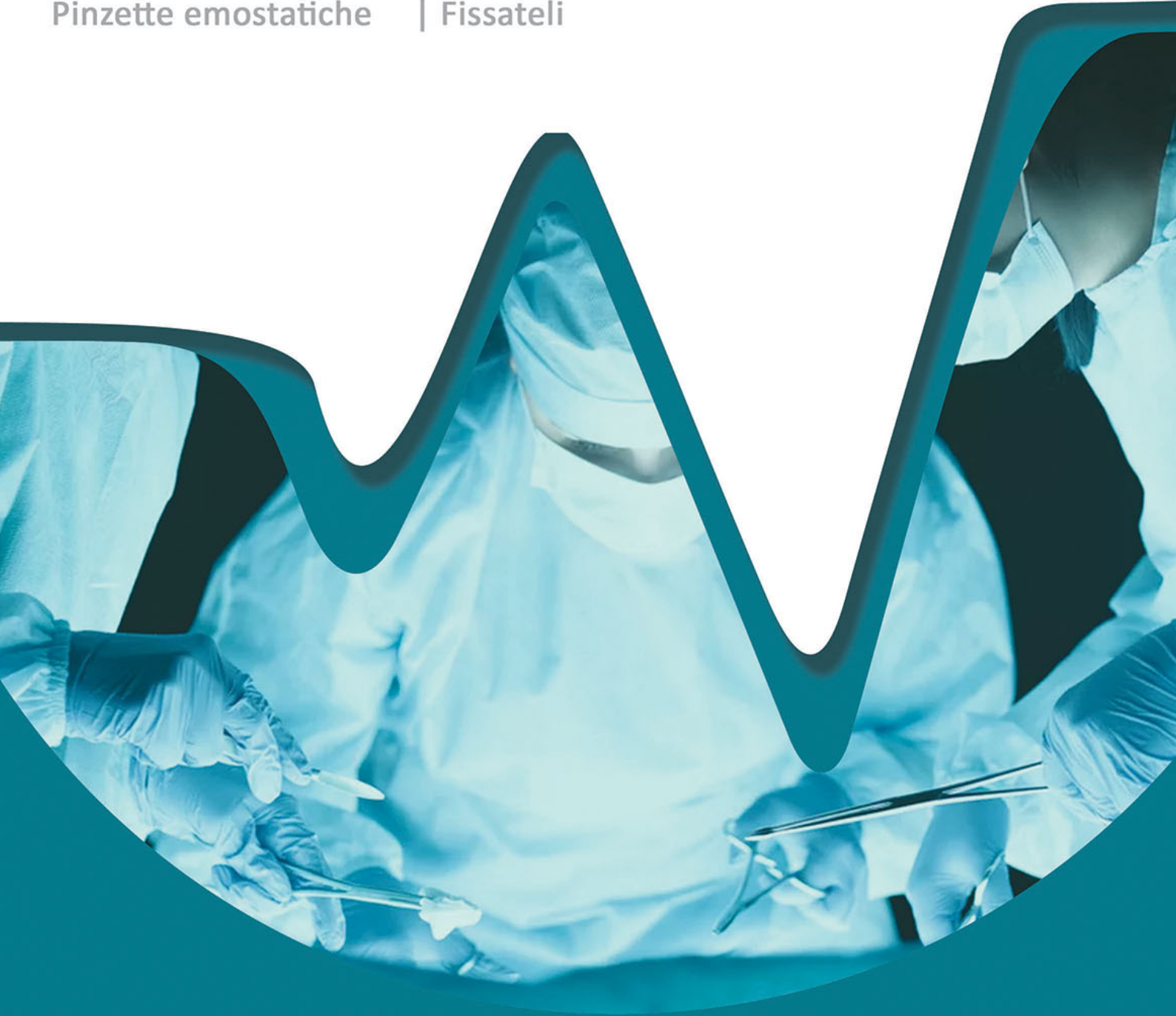

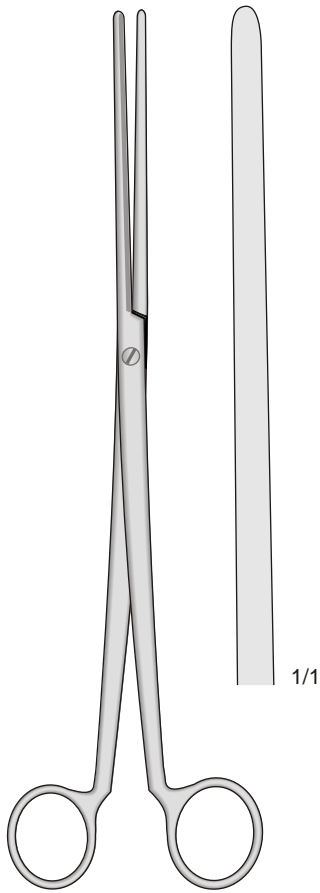

COLLIN
05-100-26
260 mm

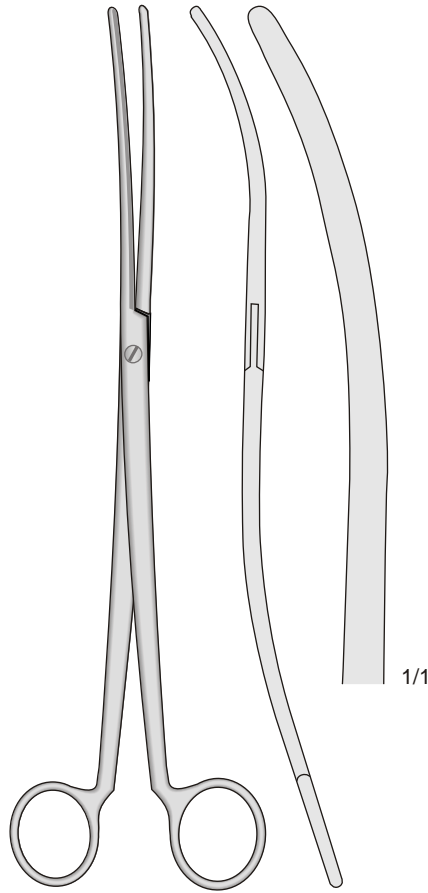

COLLIN
05-110-26
260 mm

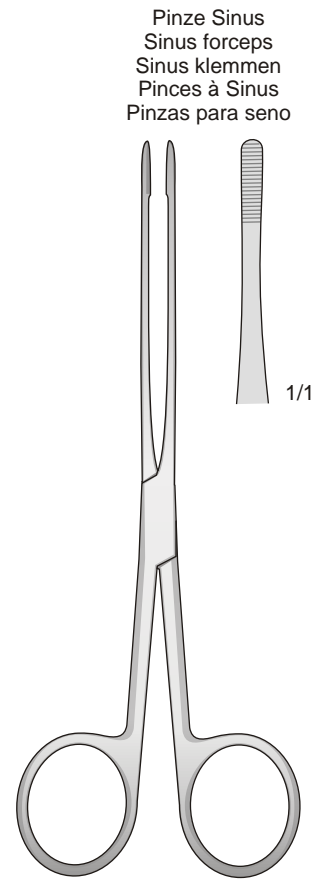

Pinze Sinus
Sinus forceps
Sinus klemmen
Pincas à Sinus
Pinzas para seno

LISTER
05-120-15
150 mm

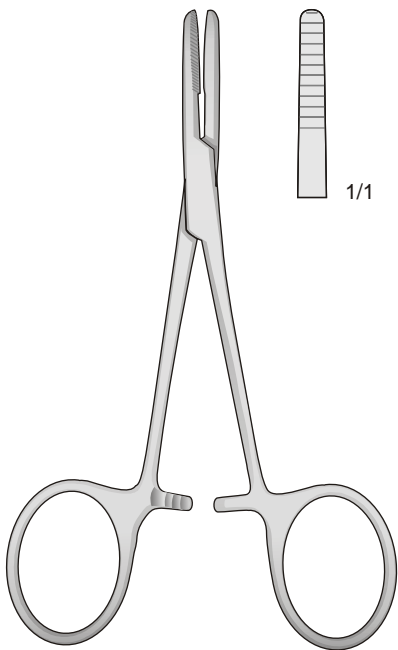

TERRIER
05-130-13
130 mm

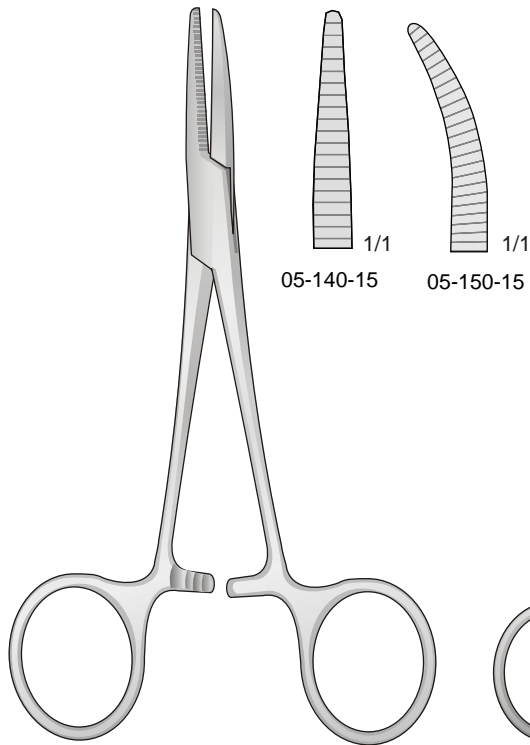

JONES
05-140
150 mm

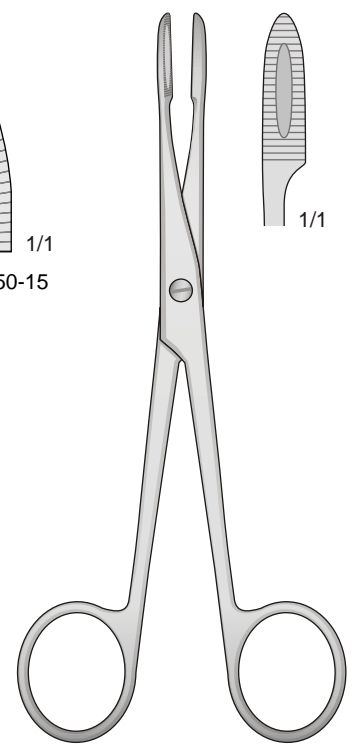

GROSS
05-160-13 - 130 mm
05-160-16 - 160 mm

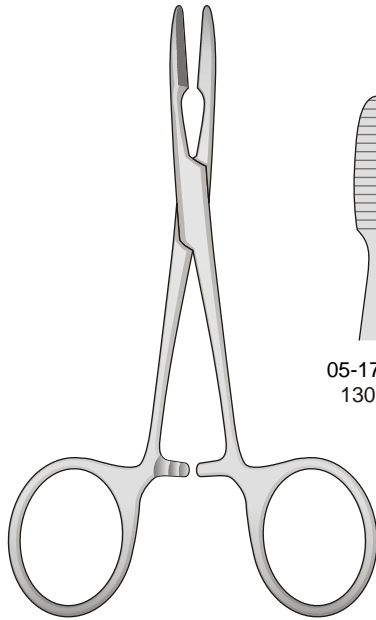

PEAN-MURPHY
05-170

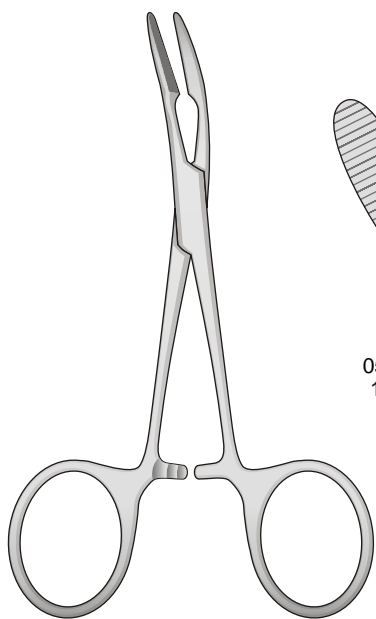
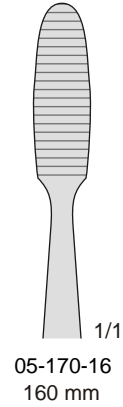
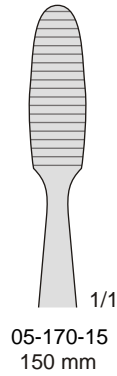
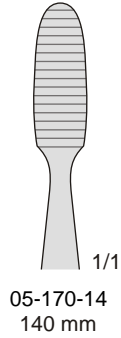
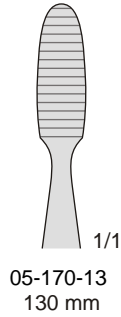

PEAN-MURPHY
05-180

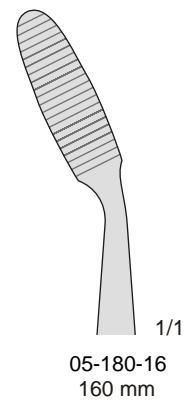
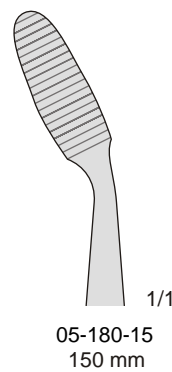
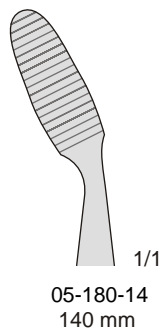
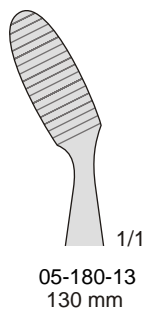

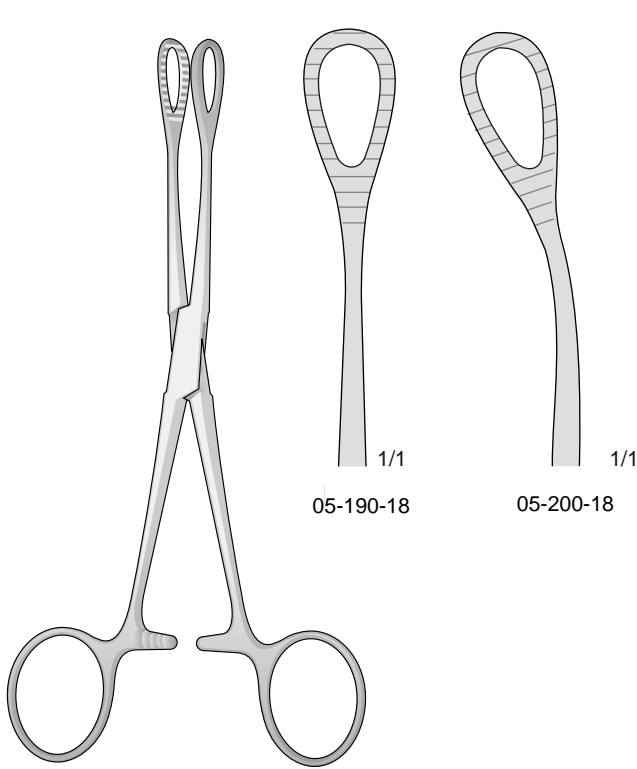

FOERSTER-BALLENGER
05-190
180 mm

05-190-18

05-200-18

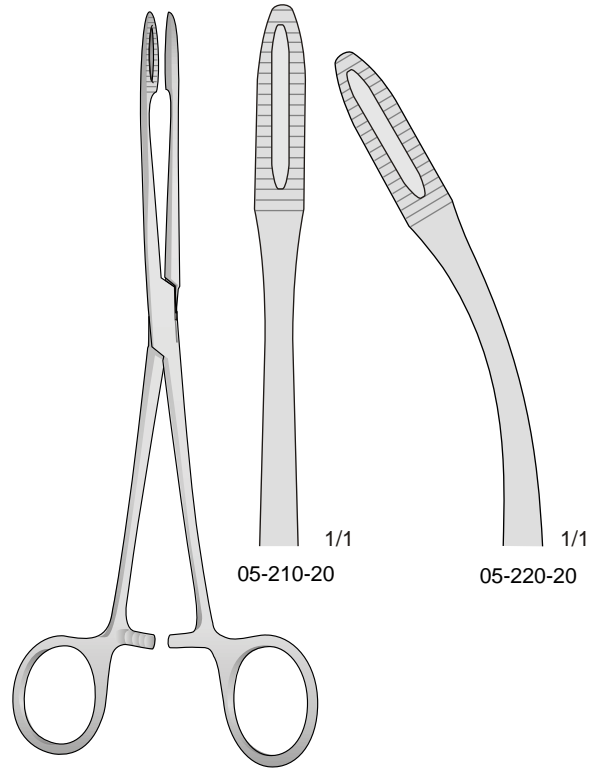

GROSS
05-210
200 mm

05-210-20

05-220-20

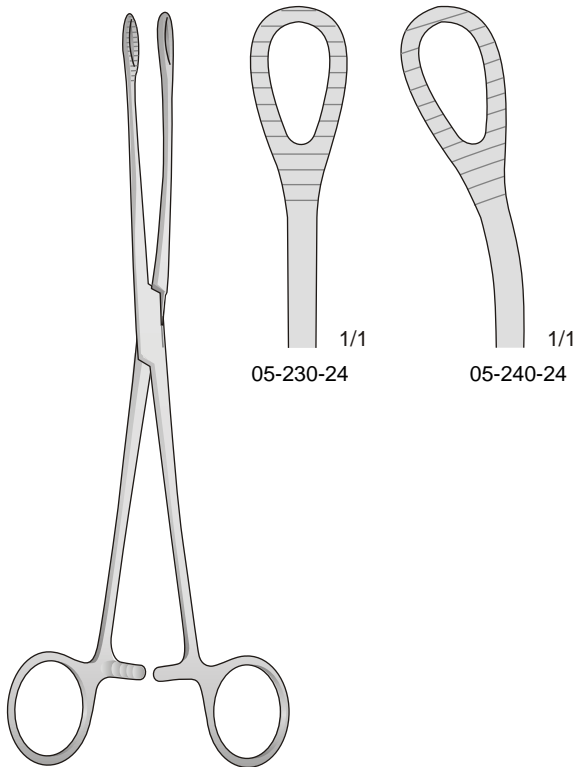

FOERSTER-BALLENGER
05-230
240 mm

05-230-24

05-240-24

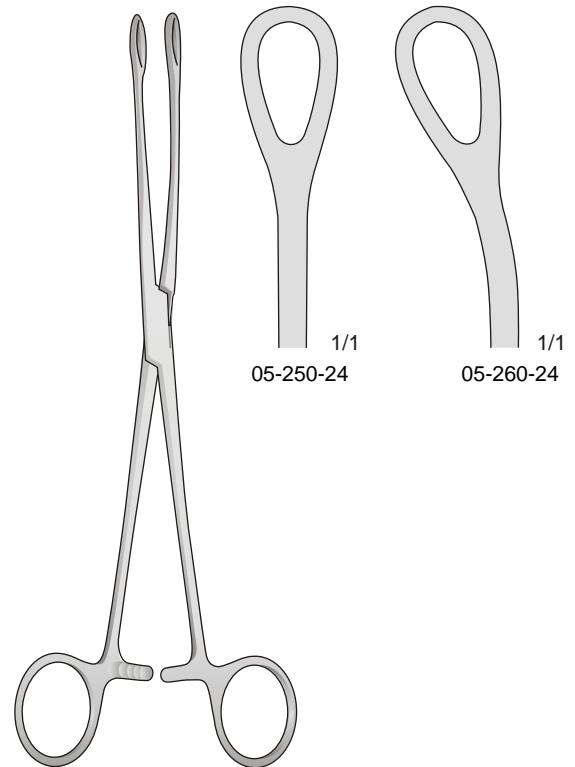

FOERSTER-BALLENGER
05-250
240 mm

05-250-24

05-260-24

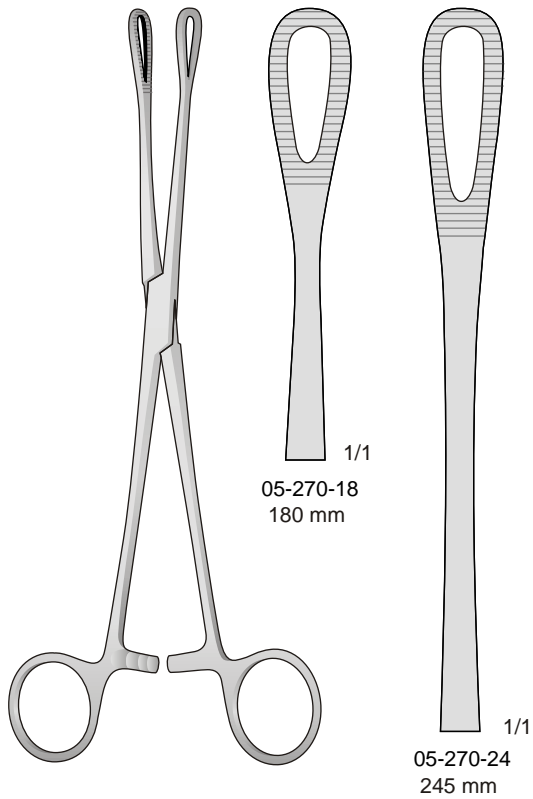

RAMPLEY
05-270

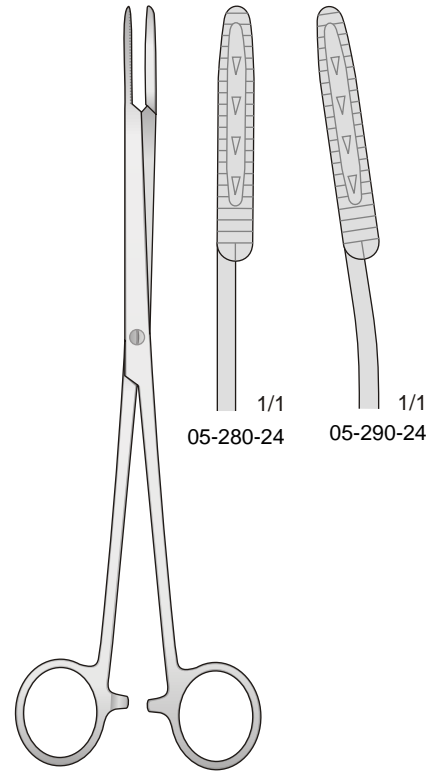

MAIER
05-280
245 mm

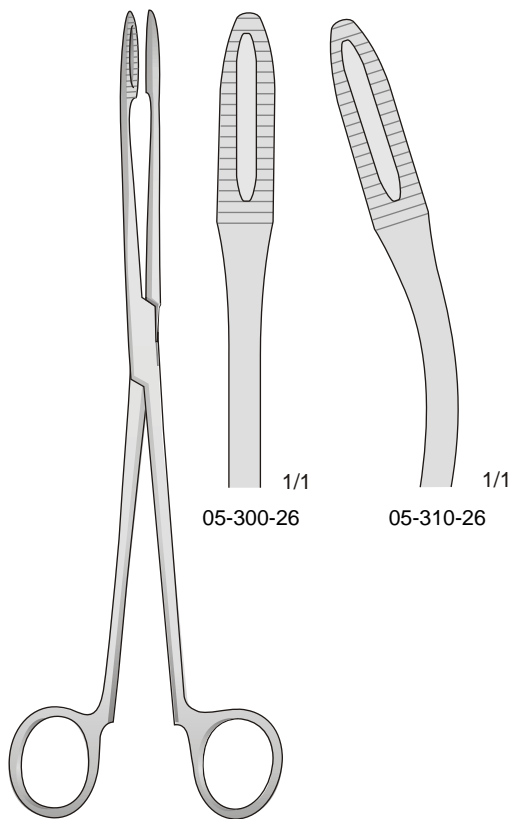

MAIER
05-300
265 mm

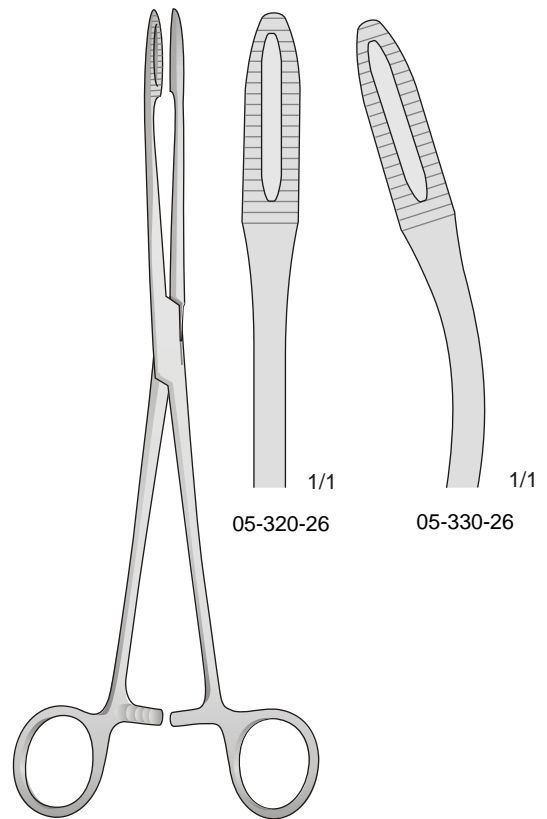

MAIER
05-320
265 mm

Gommini di ricambio 2 pezzi - Pair, Rubber jaws, only
 Paar, Gummipolster, Allein - Paire, mors en caotchouc, seuls
 Par, Bocas de goma, sueltas

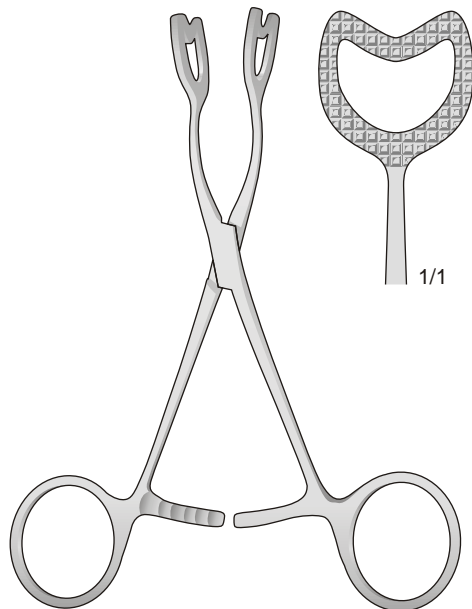

05-340-14
140 mm

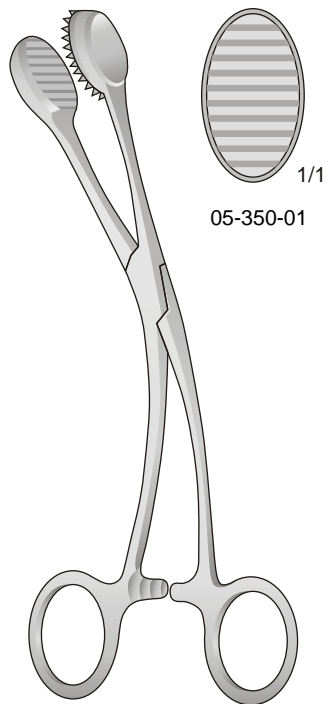

YOUNG
05-350
160 mm

Gommini di ricambio 2 pezzi - Pair, Rubber jaws, only
 Paar, Gummipolster, Allein - Paire, mors en caotchouc, seuls
 Par, Bocas de goma, sueltas

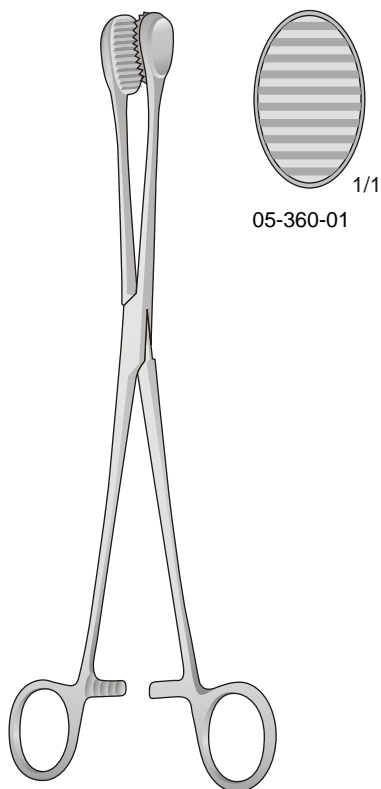

CHILD
05-360-24
240 mm

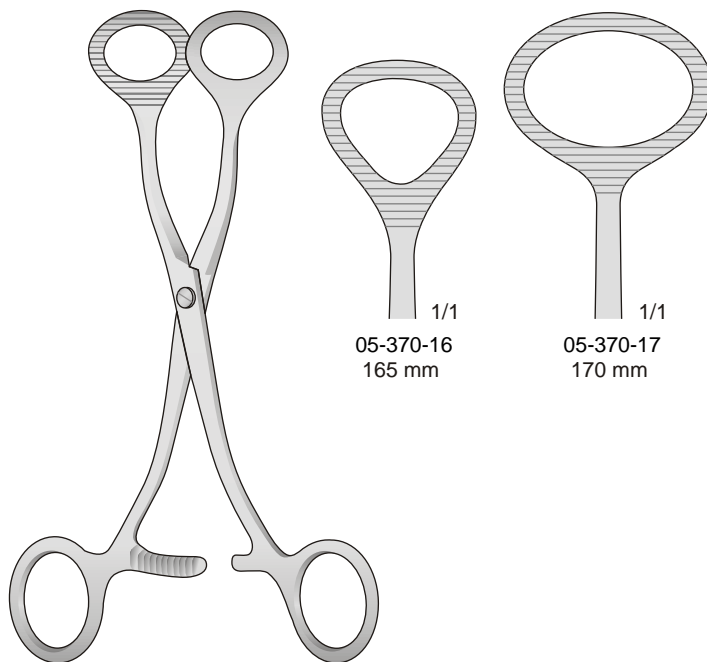

COLLIN
05-370

05-370-16
165 mm

05-370-17
170 mm

Pinza per batuffoli e tamponi
Cotton swab-sponge holding forceps
Tupfer-Schwammzangen - Pincas à tampons et éponges
Pinzas para tampones porta esponjas

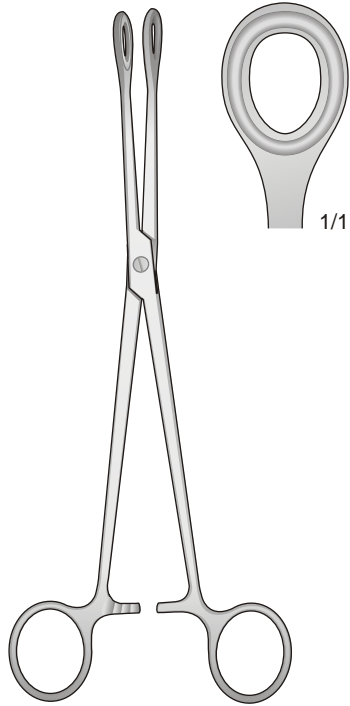

05-380-23
230 mm

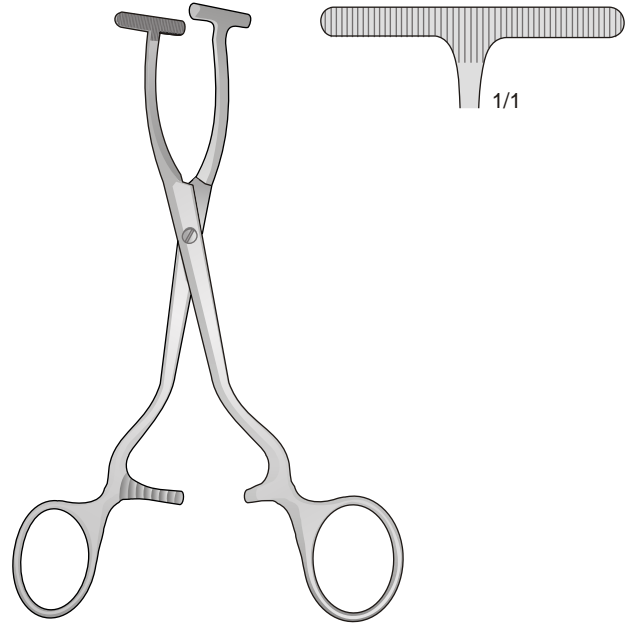

05-390-15
150 mm

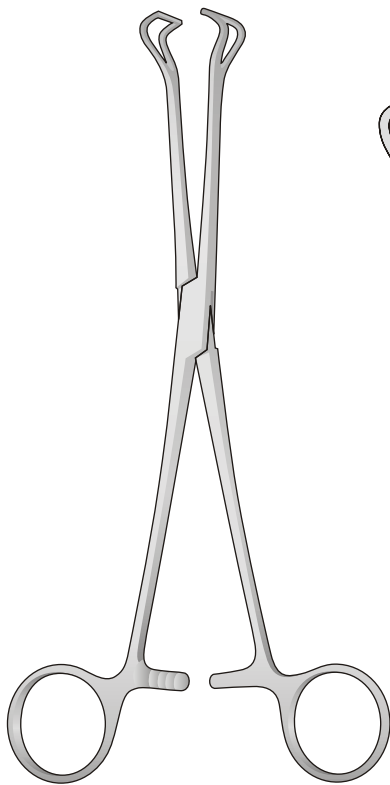

BABCOCK
05-400

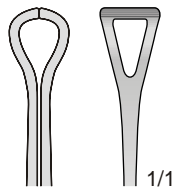

05-400-15
155 mm

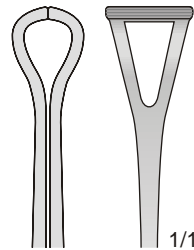

05-400-18
180 mm

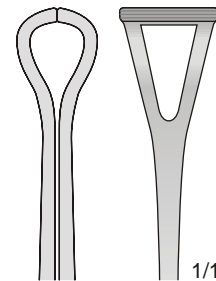

05-400-24
240 mm

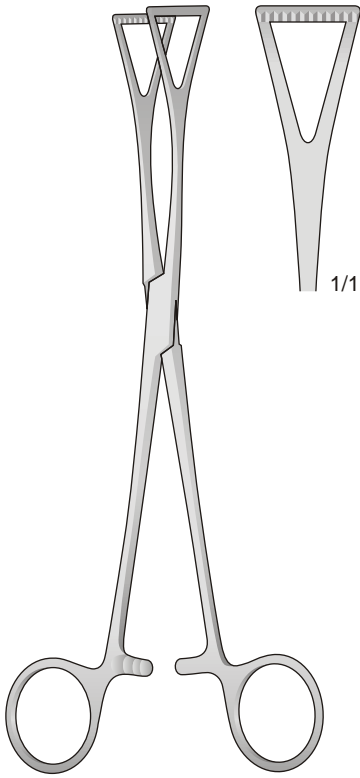

DUVAL
05-410-18
185 mm

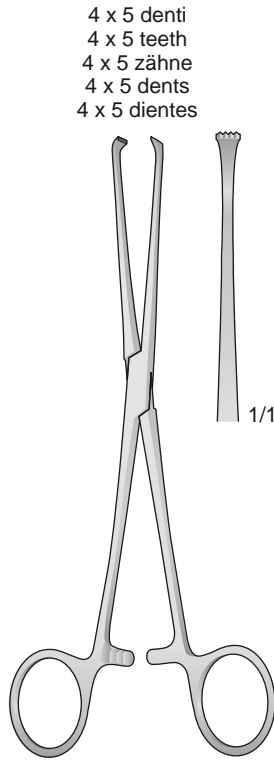

4 x 5 denti
4 x 5 teeth
4 x 5 zähne
4 x 5 dents
4 x 5 dientes

BABY-ALLIS
05-420-13
130 mm

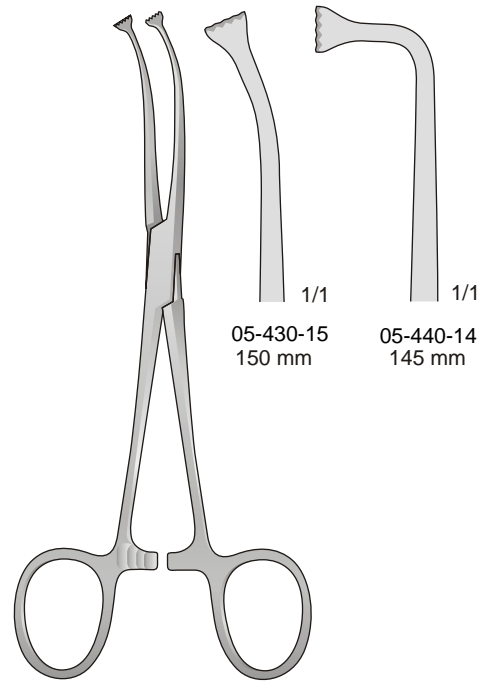

ALLIS
05-430

05-430-15
150 mm

05-440-14
145 mm

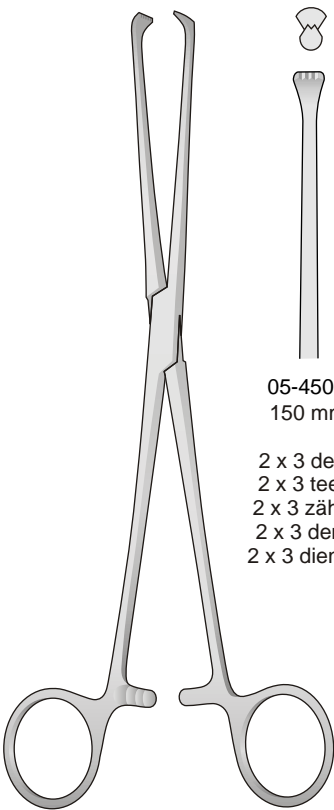

ALLIS
05-450

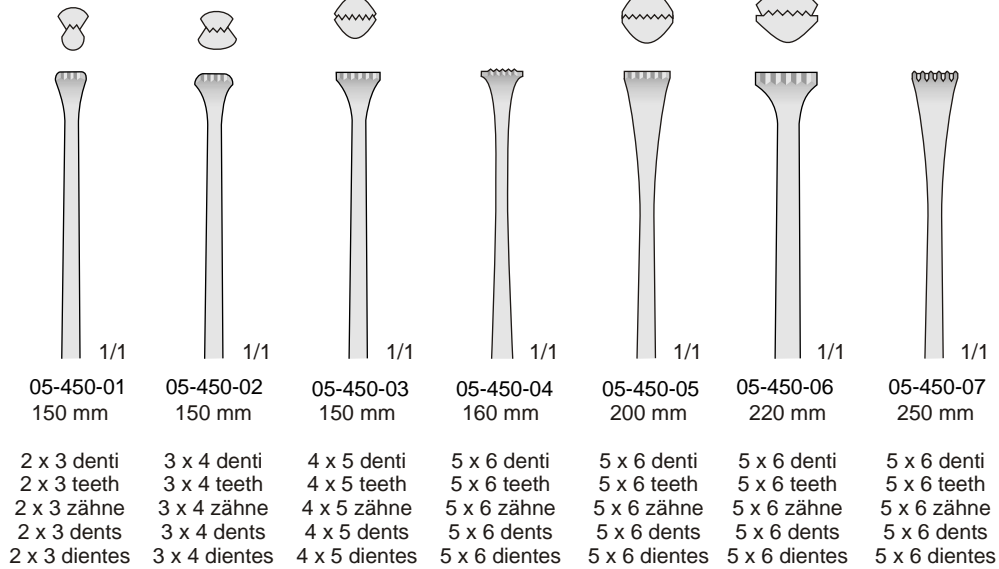

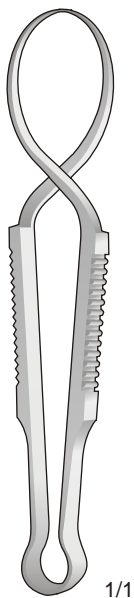

1/1

SCHAEDEL
05-460-08
85 mm

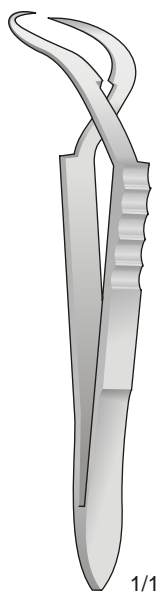

1/1

JONES
05-470-09
90 mm

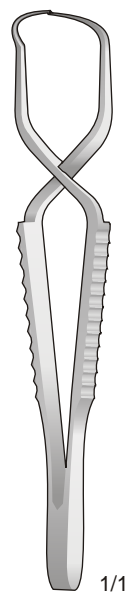

1/1

FAURE
05-480-08
85 mm

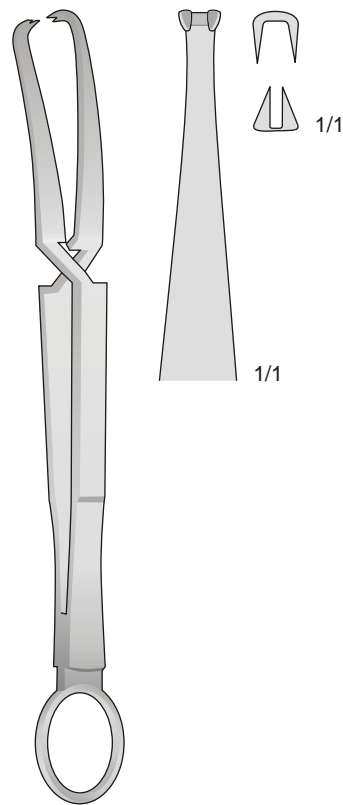

1/1

1/1

DOYEN
05-490-18
180 mm

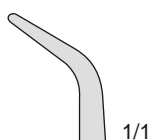

1/1

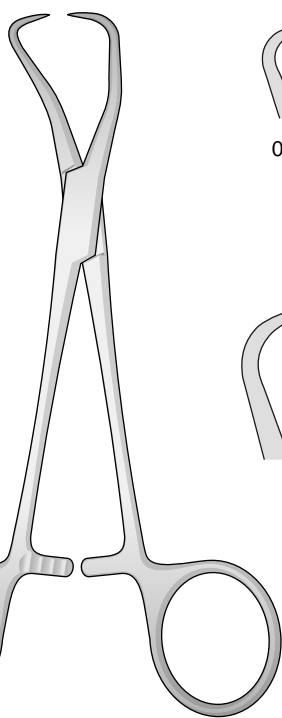

BACKHAUS
05-500

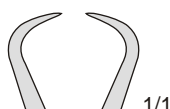

1/1

05-500-01
90 mm



1/1

05-500-02
100 mm

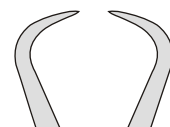

1/1

05-500-03
110 mm

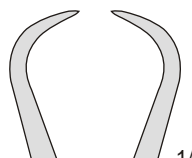

1/1

05-500-04
130 mm

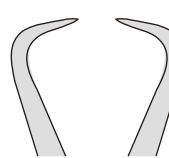

1/1

05-500-05
135 mm

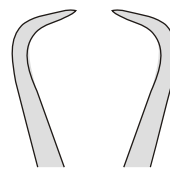

1/1

05-500-06
140 mm

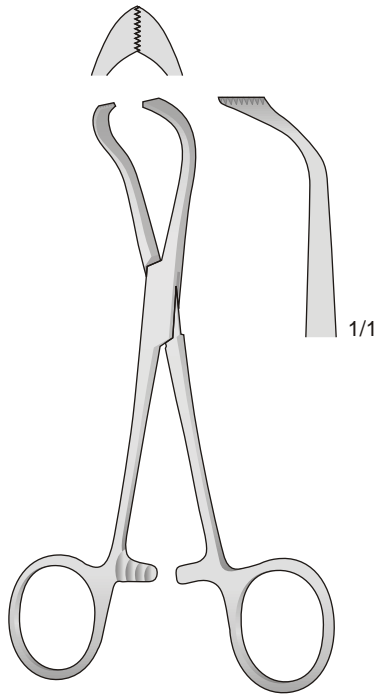

LORNA
05-510-10
100 mm

Per teli di carta
For paper cloths
Für Papiertücher
Pour Champs en papier

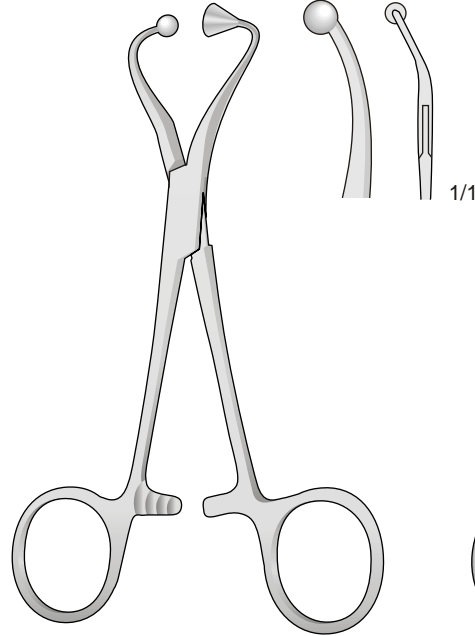

05-520-11
115 mm

Per teli di carta
For paper cloths
Für Papiertücher
Pour Champs en papier

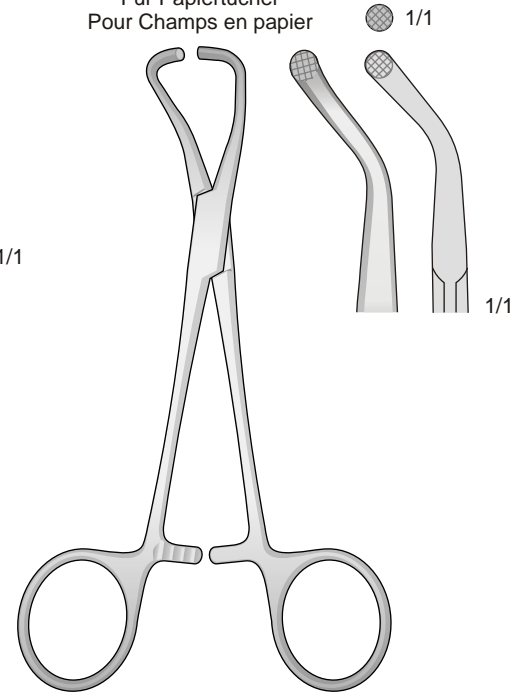

05-530-13
130 mm

Per teli di carta
For paper cloths
Für Papiertücher
Pour Champs en papier

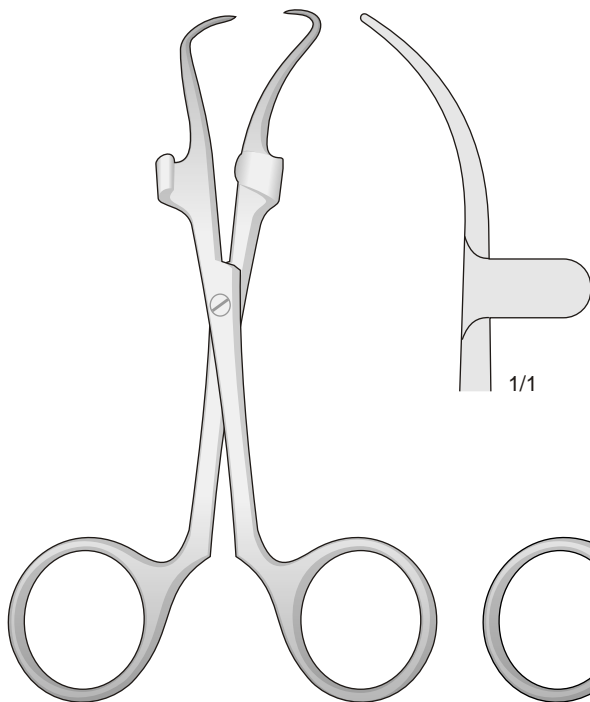

ROBIN
05-540-14
140 mm

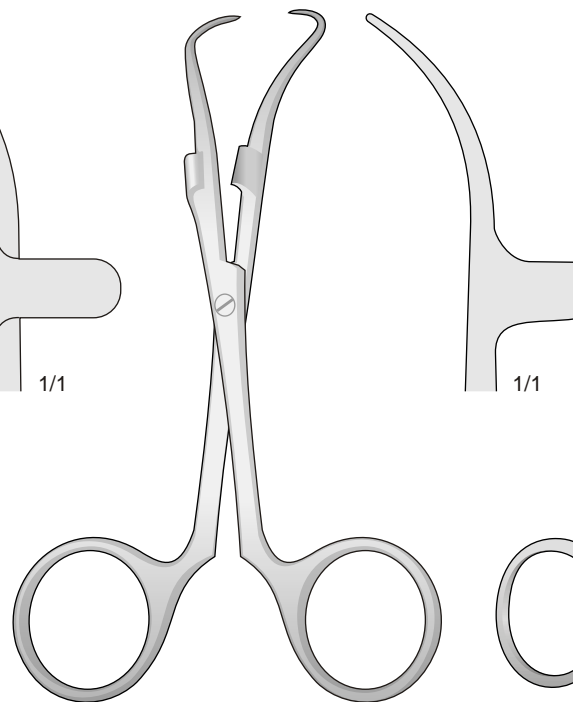

ROBIN
05-550-14
140 mm

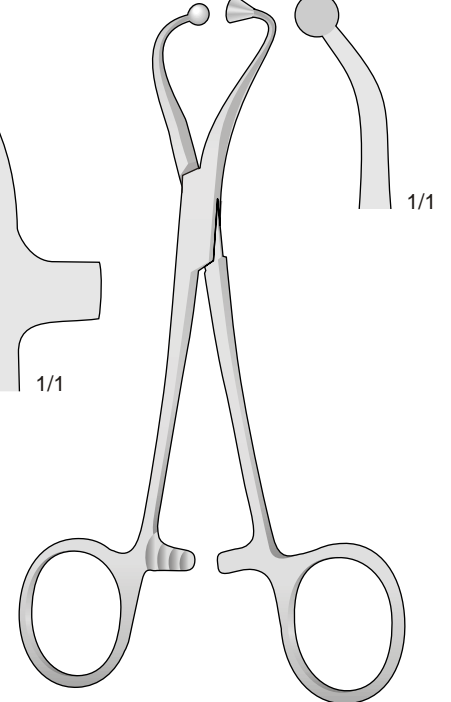

05-560-14
140 mm

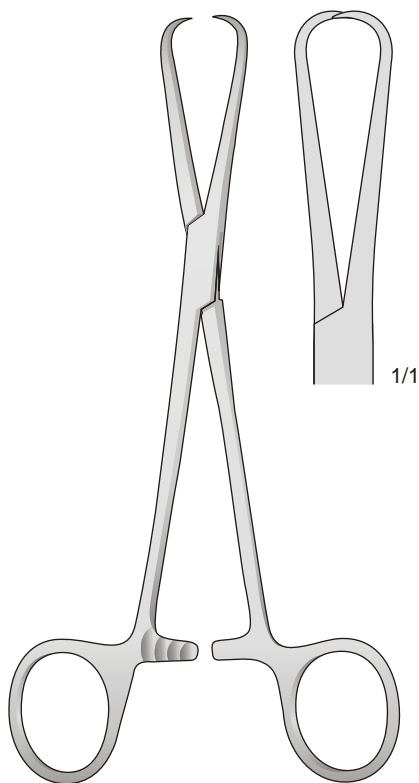

BERNHARD
05-570-16
165 mm

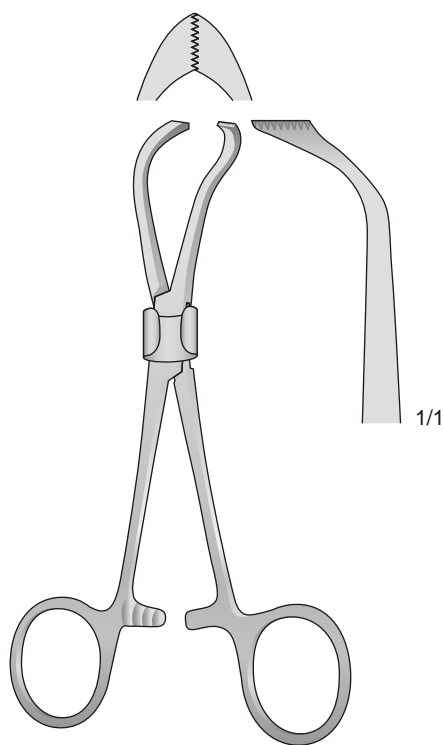

05-580-01 Ø 9 mm 580-03 Ø 12 mm
05-580-02 Ø 14 mm 580-04 Ø 17 mm
100 mm

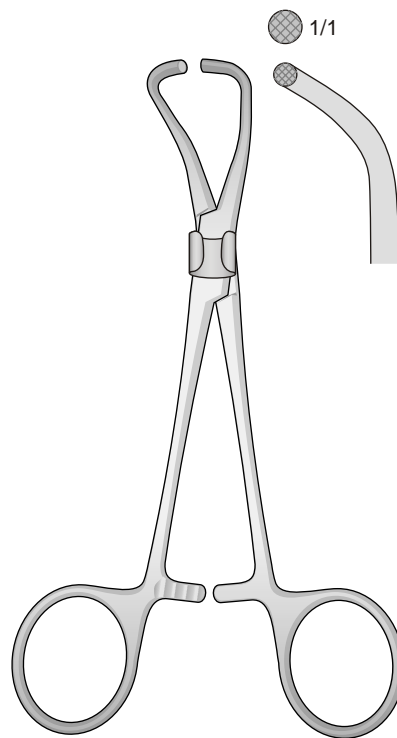

05-590-01 Ø 9 mm 590-03 Ø 12 mm
05-590-02 Ø 14 mm 590-04 Ø 17 mm
130 mm
05-590

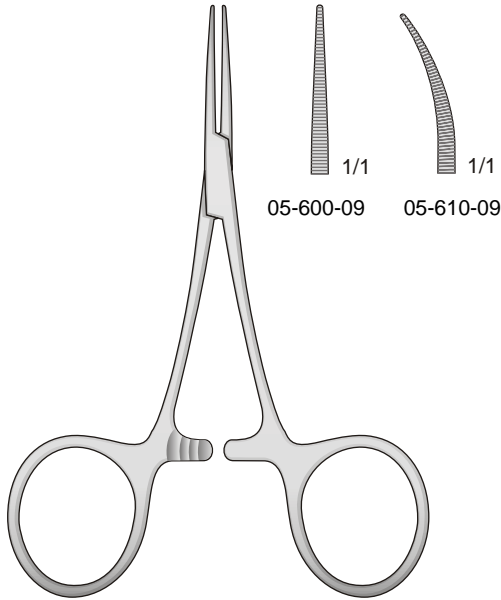

HARTMANN-BABY-MOSQUITO
05-600
95 mm

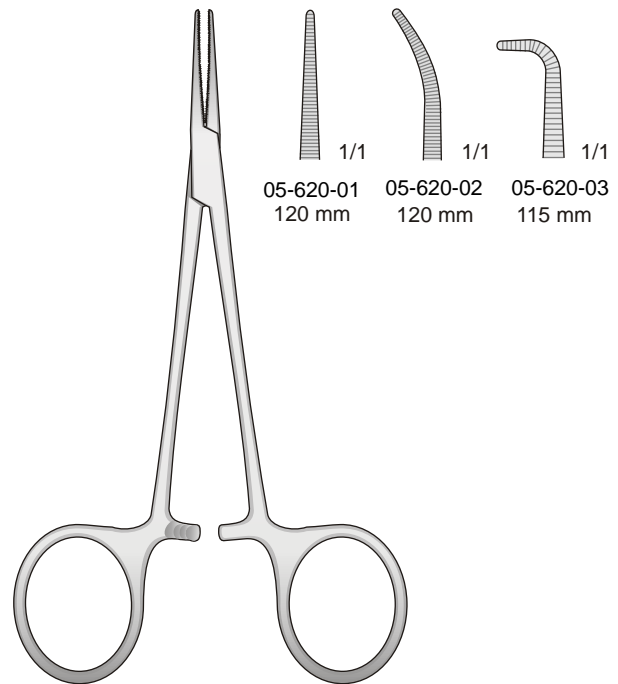

MICRO-HALSTED
05-620

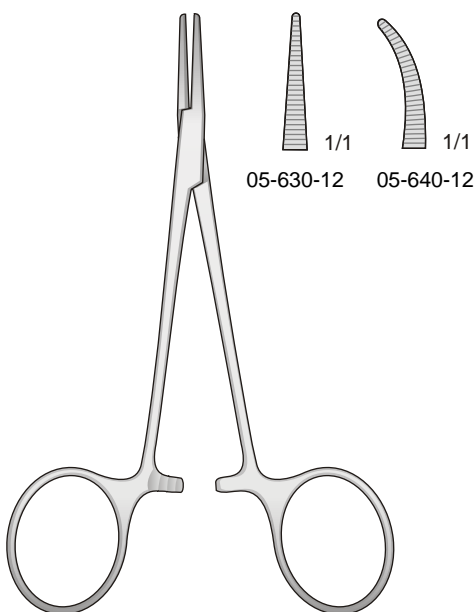

HALSTED-MOSQUITO
05-630
120 mm

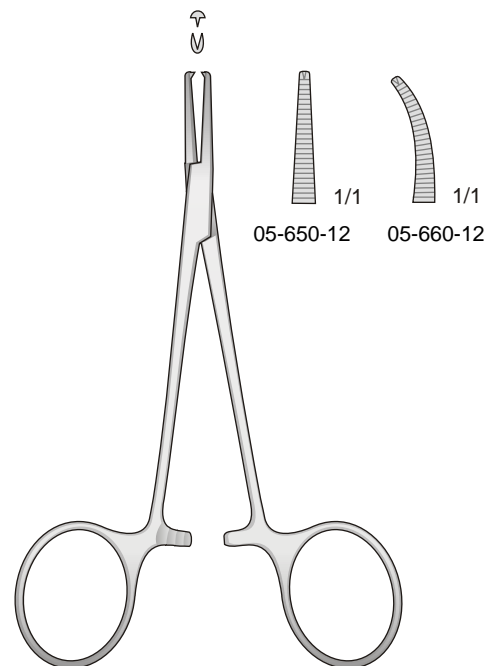

HALSTED-MOSQUITO
05-650
120 mm

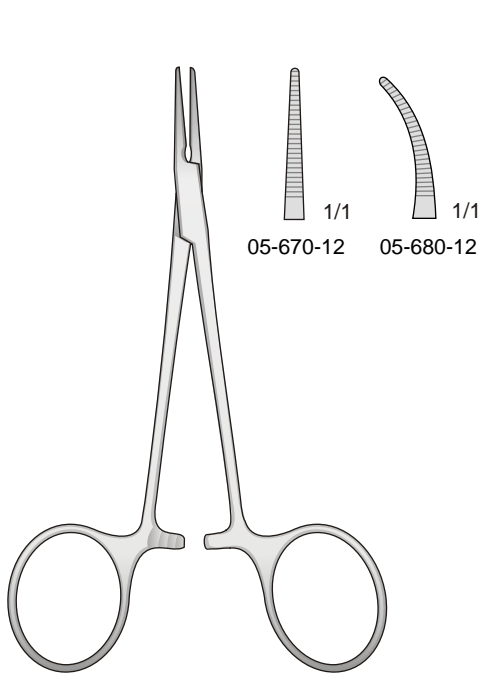

HALSTED
05-670
125 mm

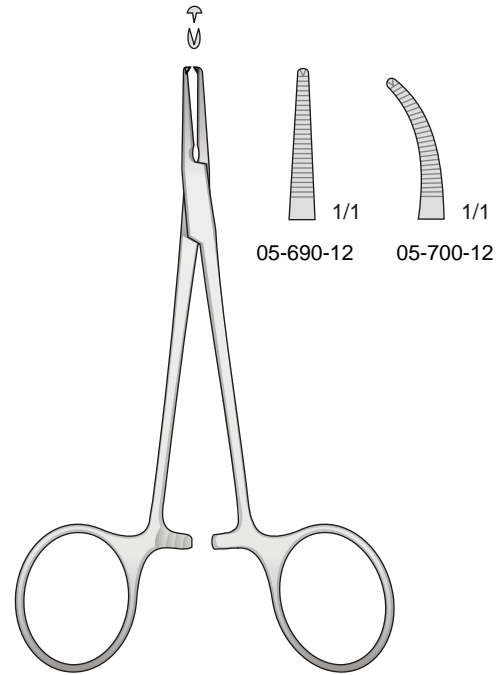

HALSTED
05-690
125 mm

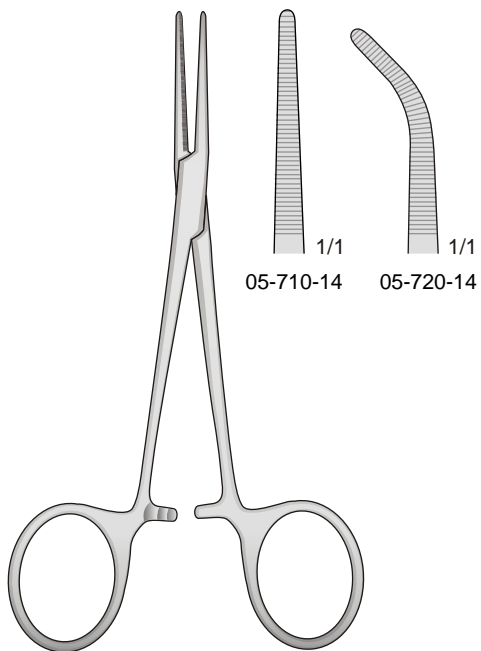

GIDEF
05-710
140 mm

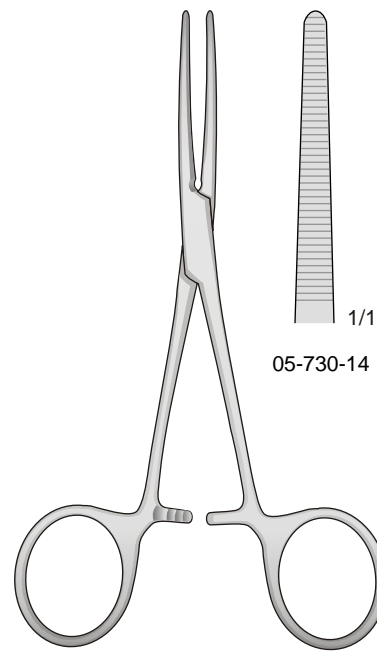

PEAN
05-730
140 mm

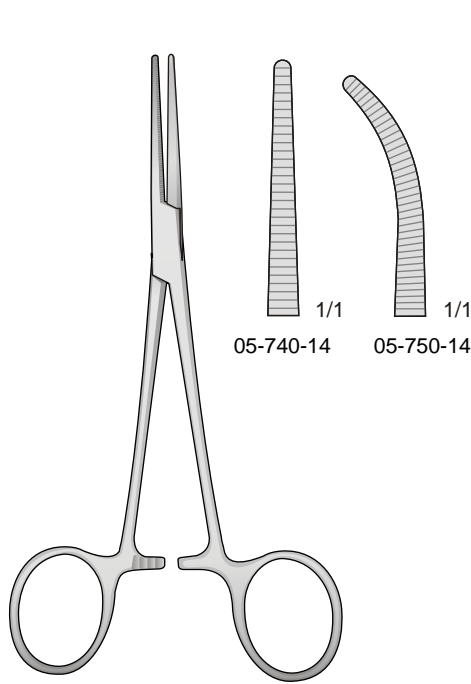

CRILE
05-740
140 mm

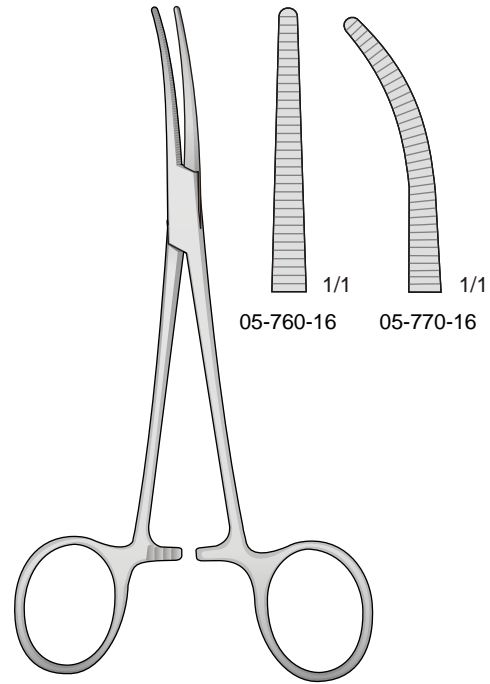

CRILE
05-760
160 mm

Curve sul lato
Curved to side
Seitwärts gebogen
Courbes latérales
Curvas laterales

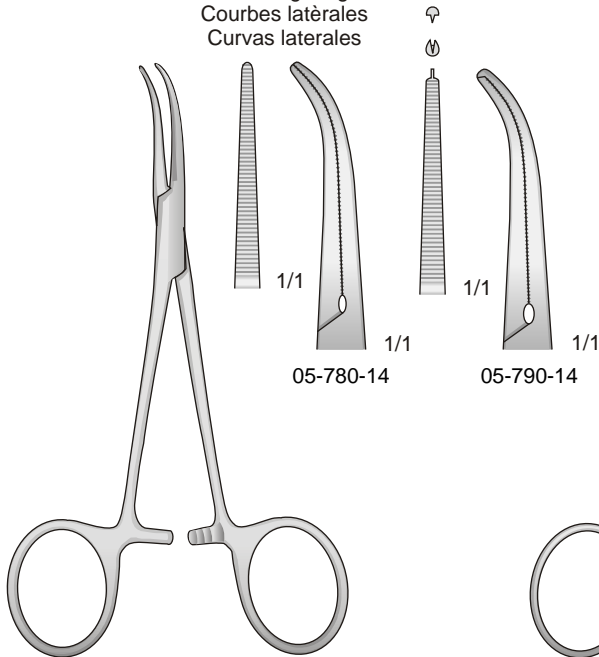

DANDY
05-780
140 mm

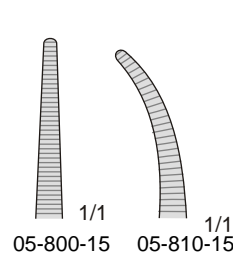

LERICHE
05-800
150 mm

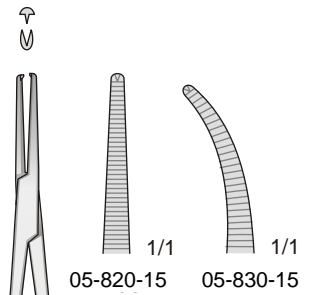

LERICHE
05-820
150 mm

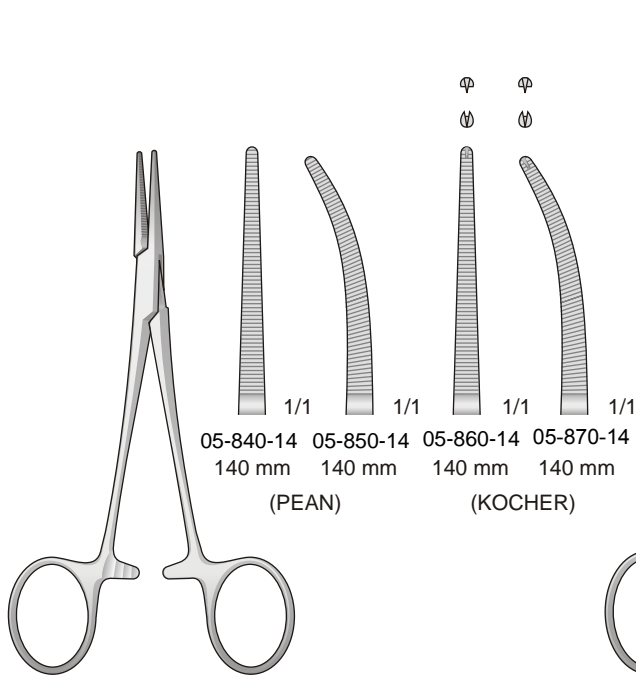

BABY-CRILE
05-840
140 mm

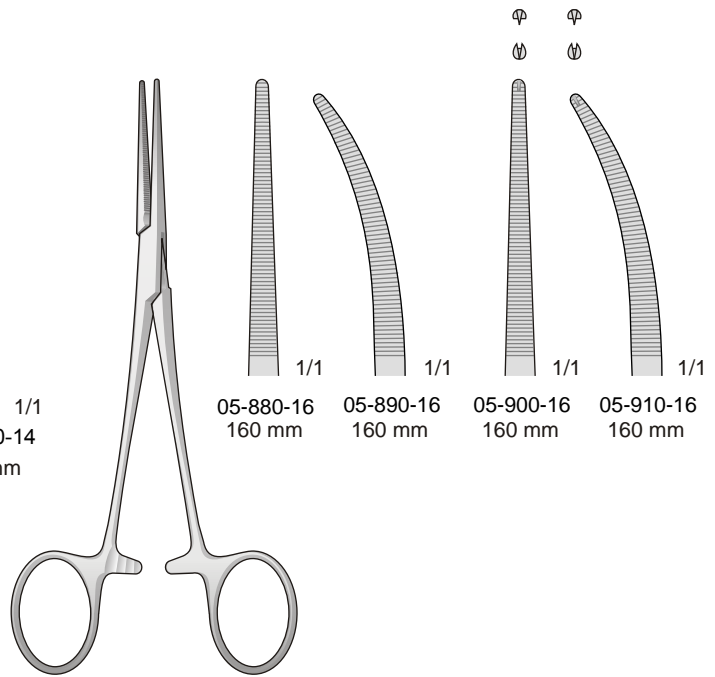

CRILE
05-880
160 mm

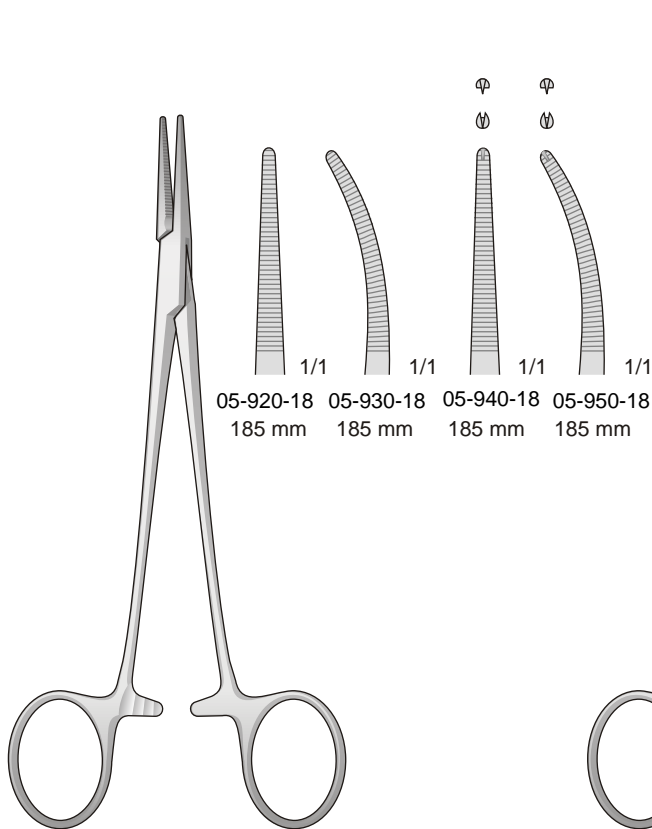

HALSTED
05-920
185 mm

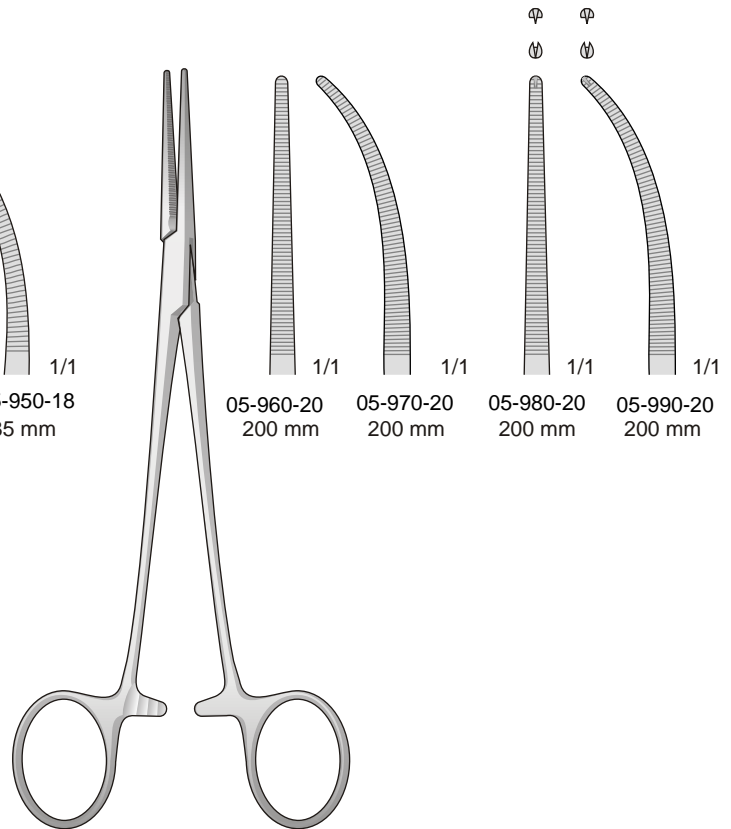

HALSTED-MOSQUITO
05-960
200 mm

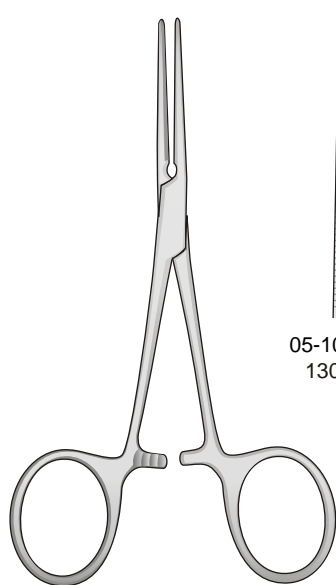

PEAN
05-1000

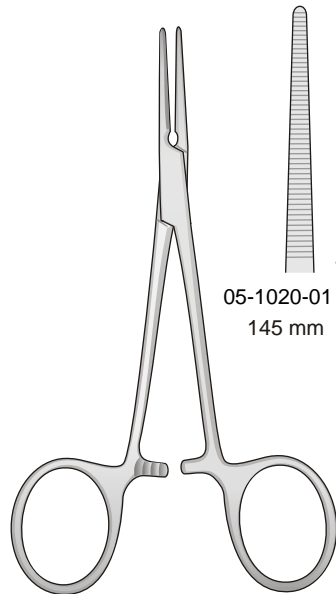
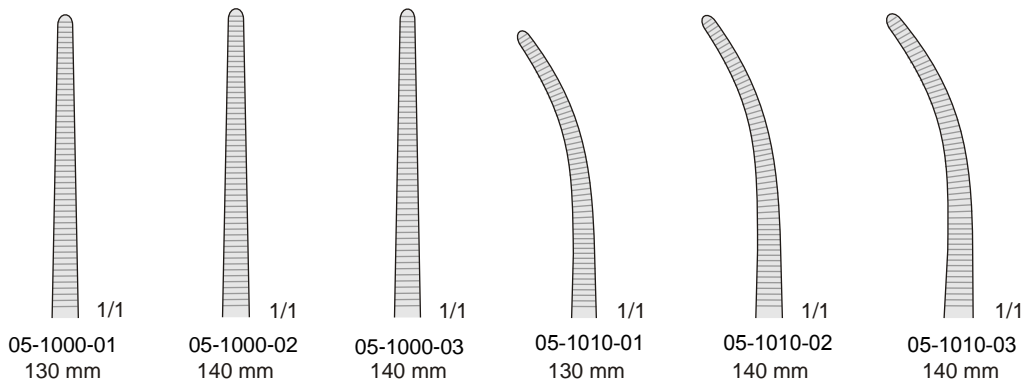

PEAN
05-1020

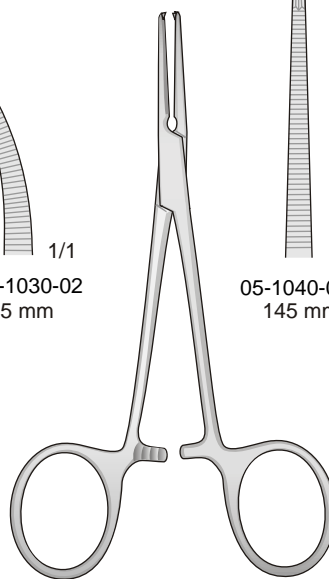
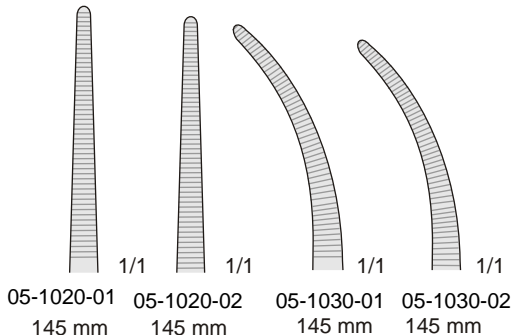

KOCHER
05-1040

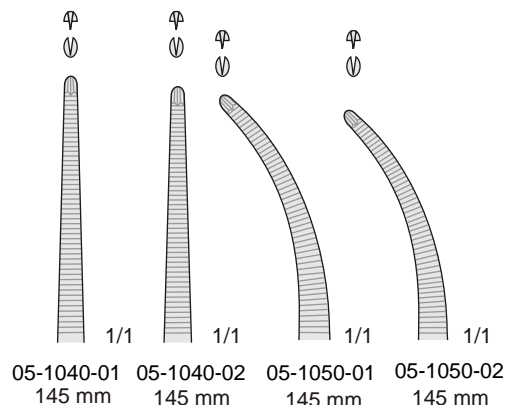

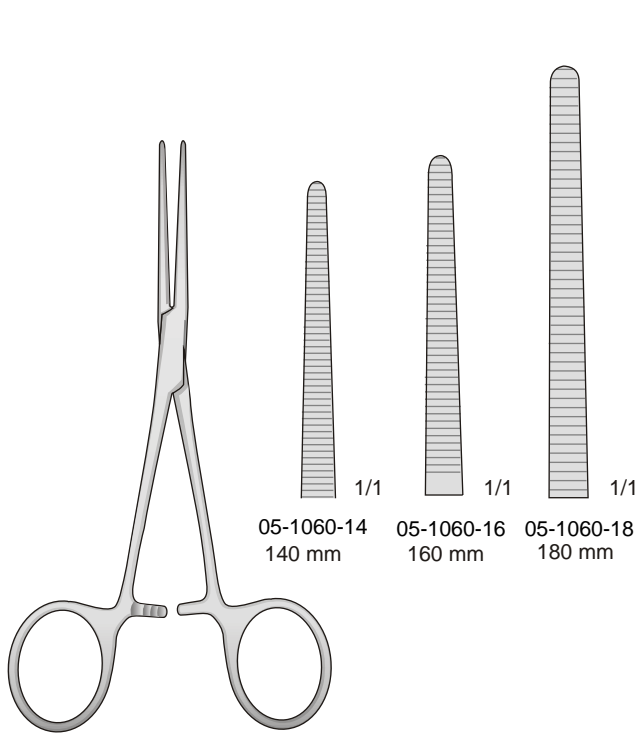

ROCHESTER-PEAN
05-1060

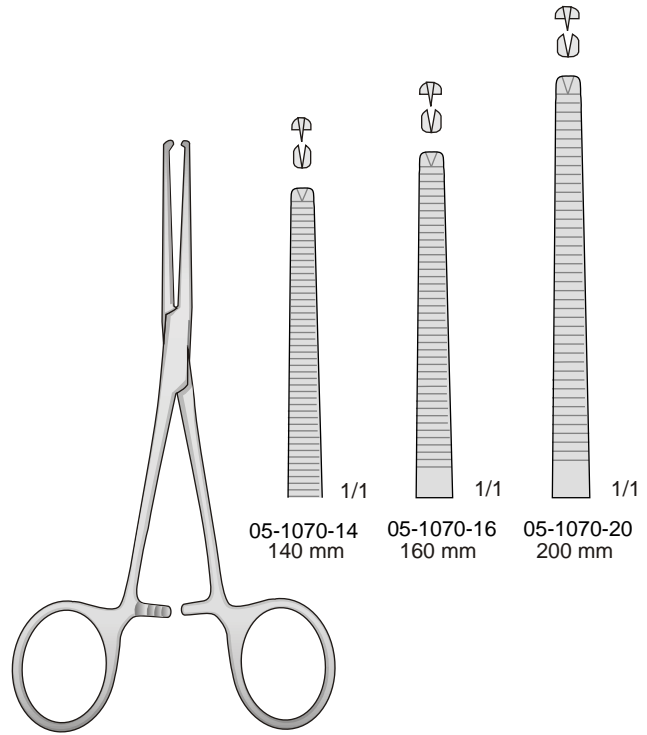

KOCHER-OCHSNER
05-1070

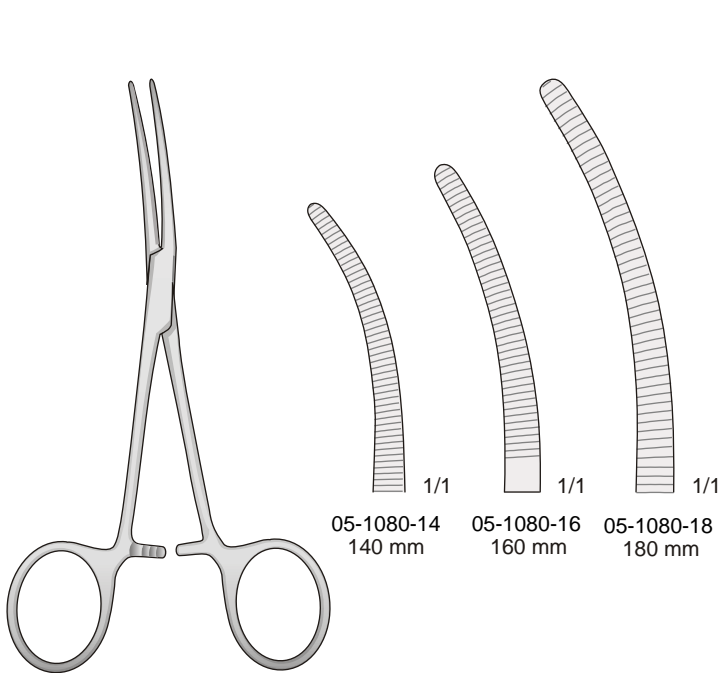

ROCHESTER-PEAN
05-1080

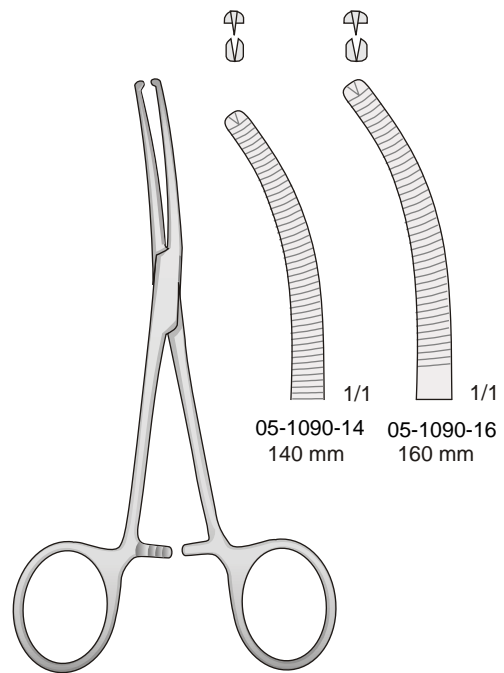

KOCHER-OCHSNER
05-1090

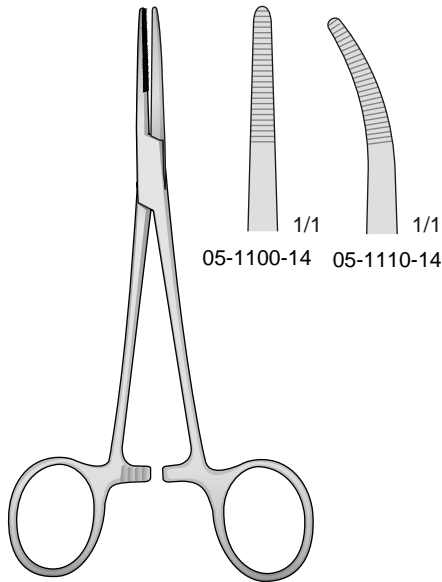

KELLY
05-1100
140 mm

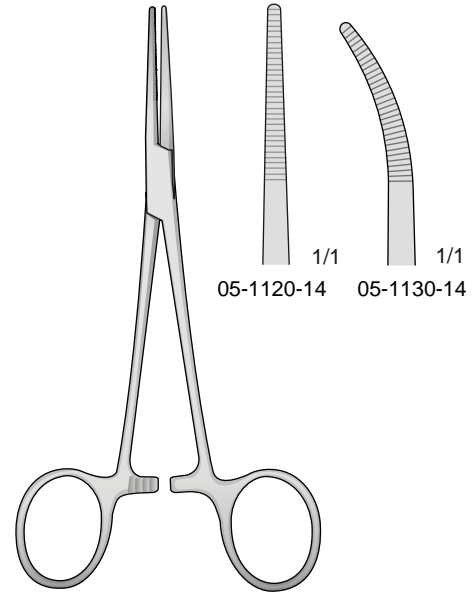

KELLY
05-1120
140 mm

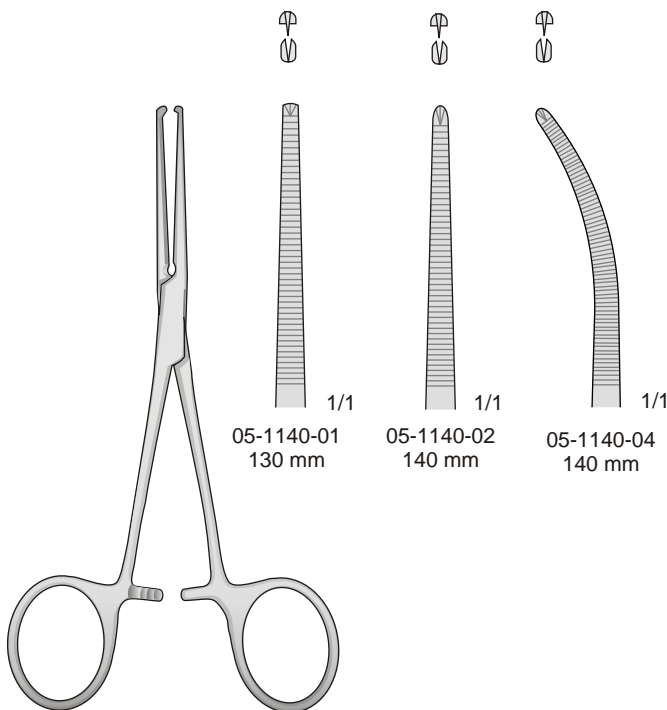

KOCHER
05-1140

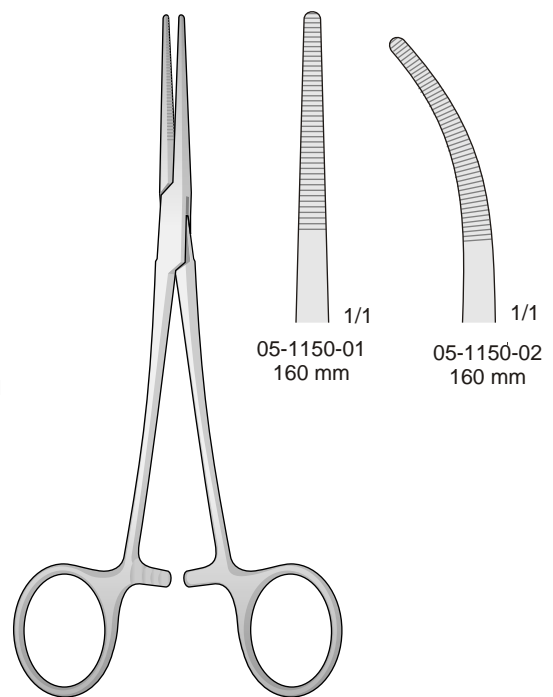

RANKIN
05-1150

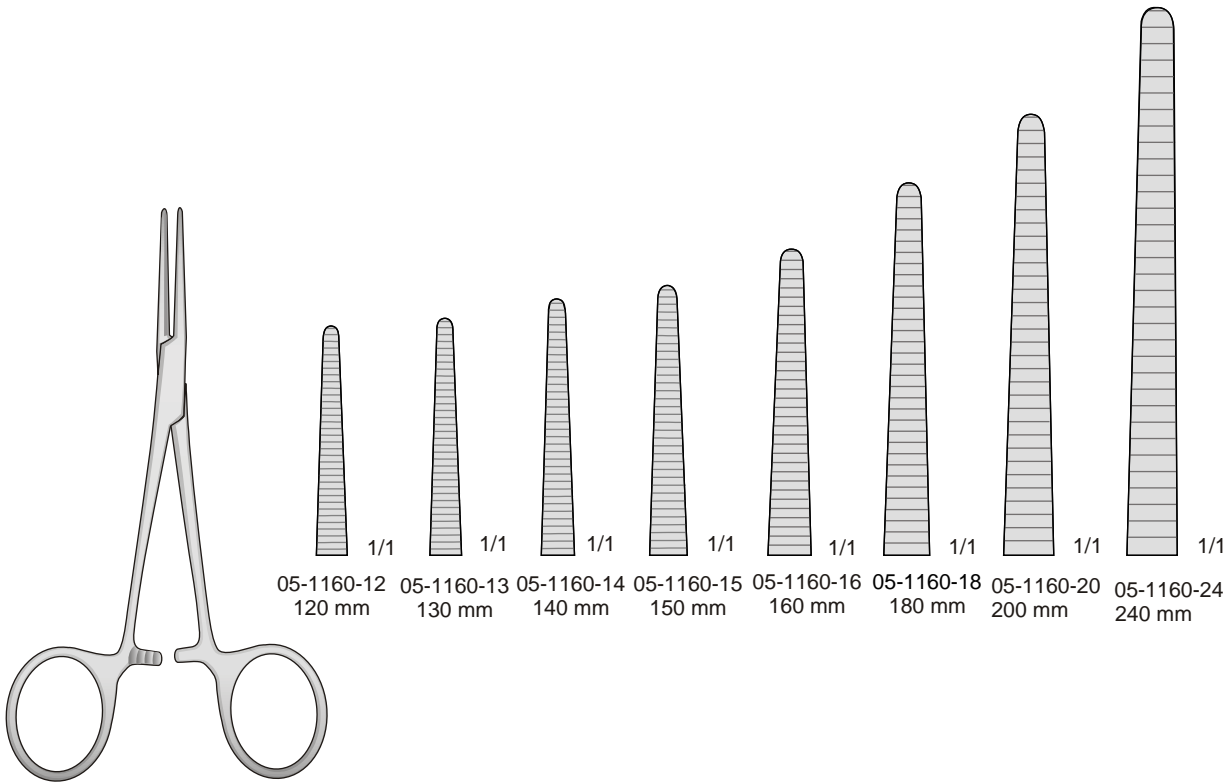

PEAN
05-1160

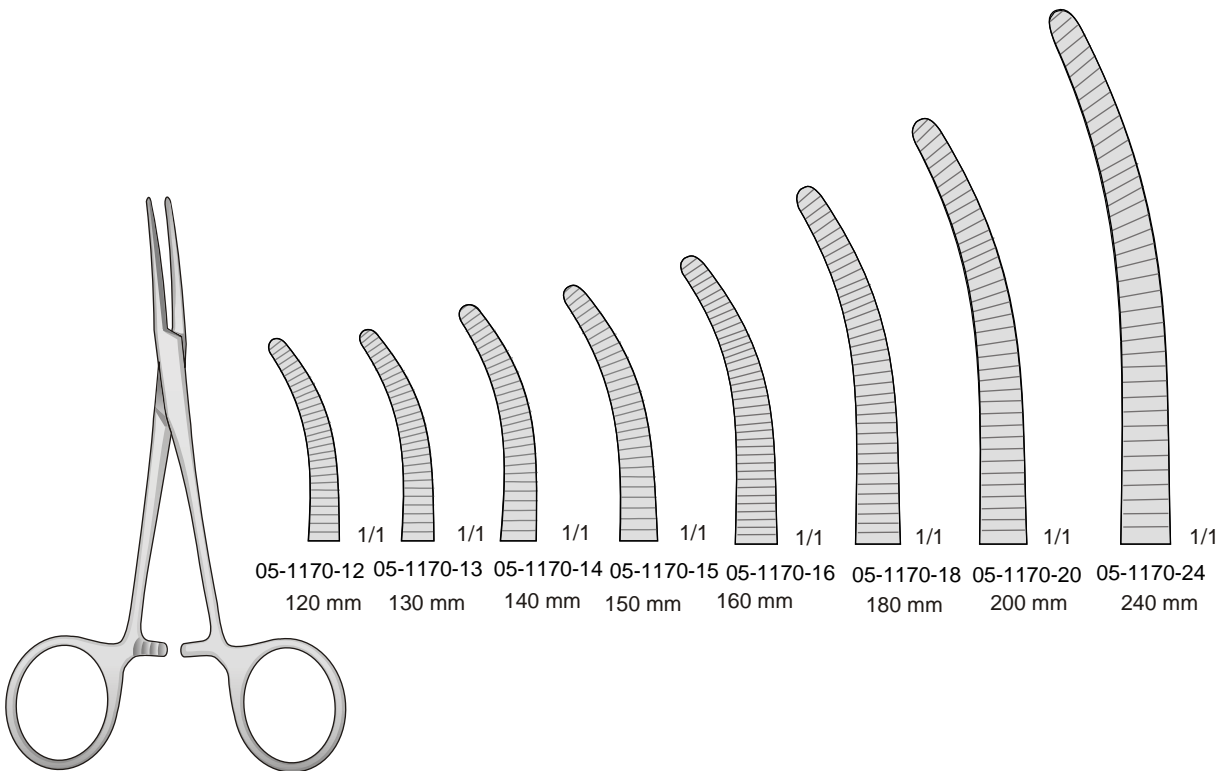

PEAN
05-1170

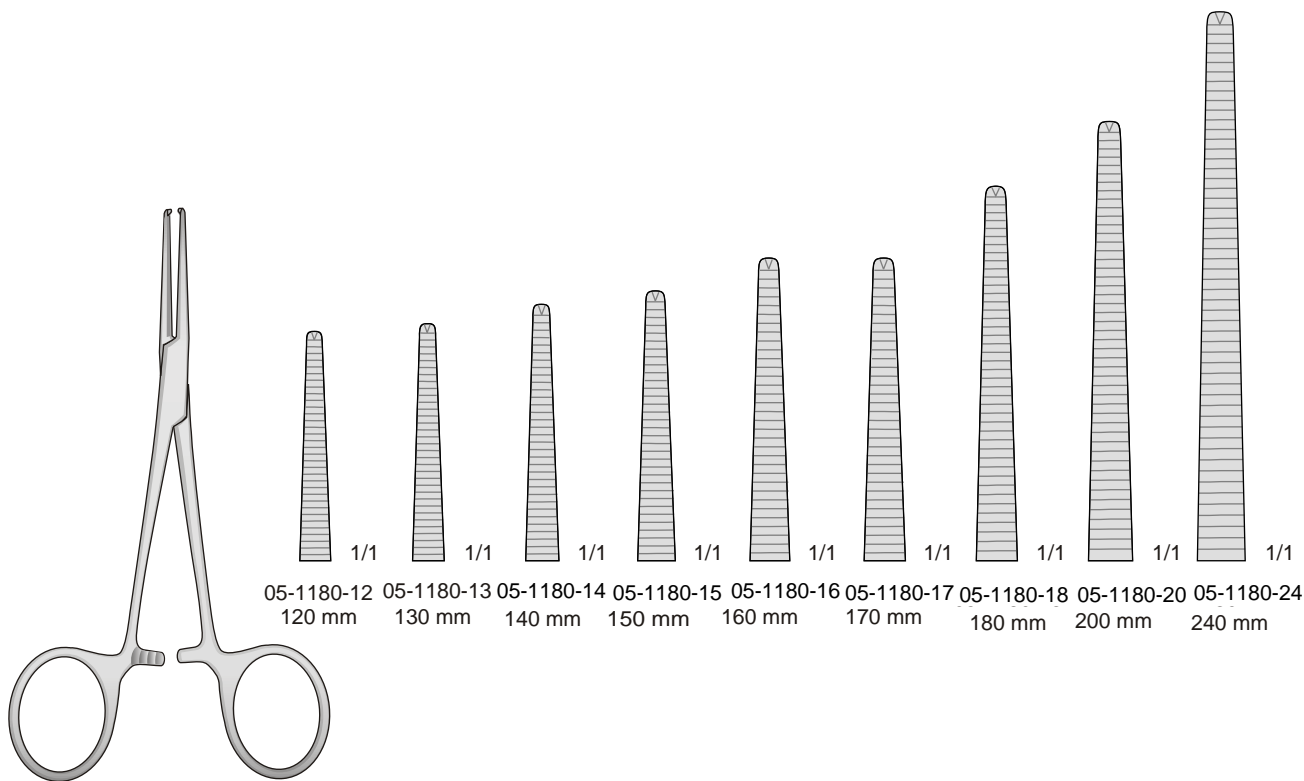

KOCHER
05-1180

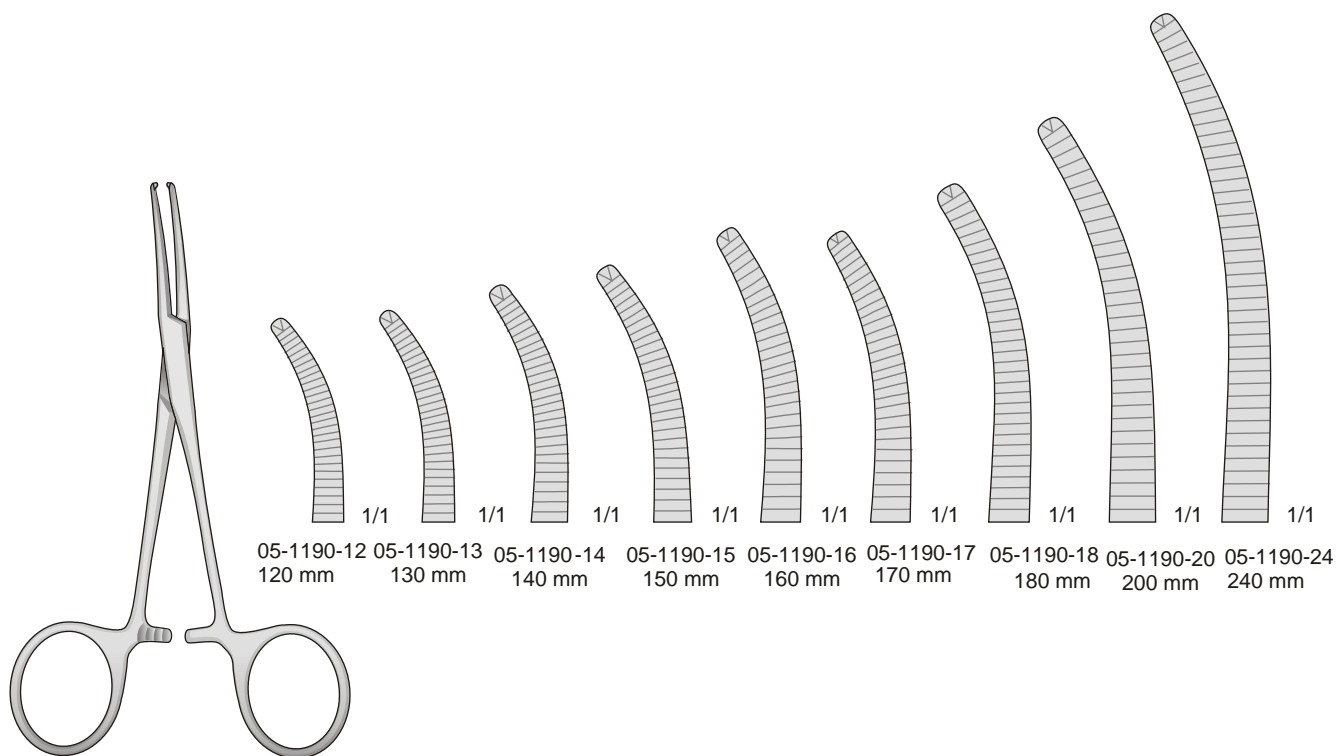

KOCHER
05-1190

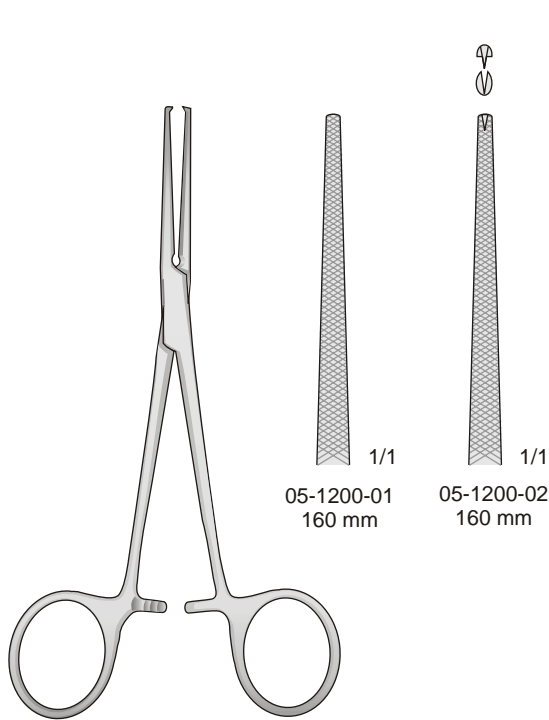

DIXON-LOVELACE
05-1200

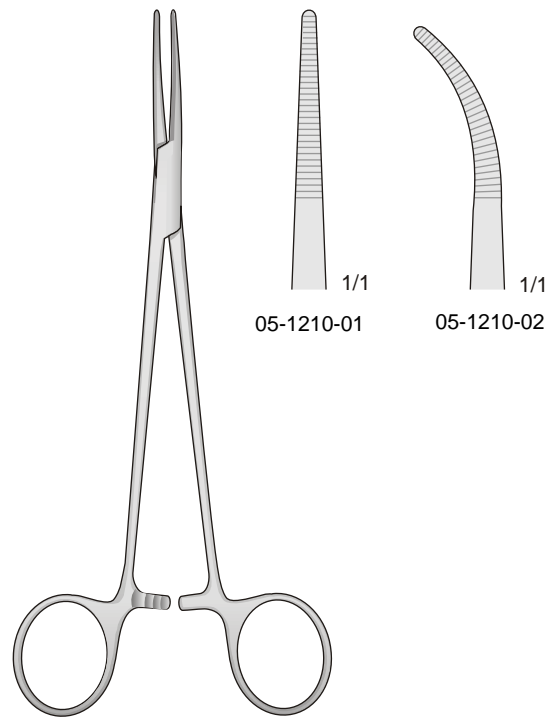

BIRKETT
05-1210
180 mm

Pinza per peritoneo - Peritoneal clamps forceps
Pritoneum klemmen - Pinces-camps pour les péritoine
Pinzas-clamps para peritoneo

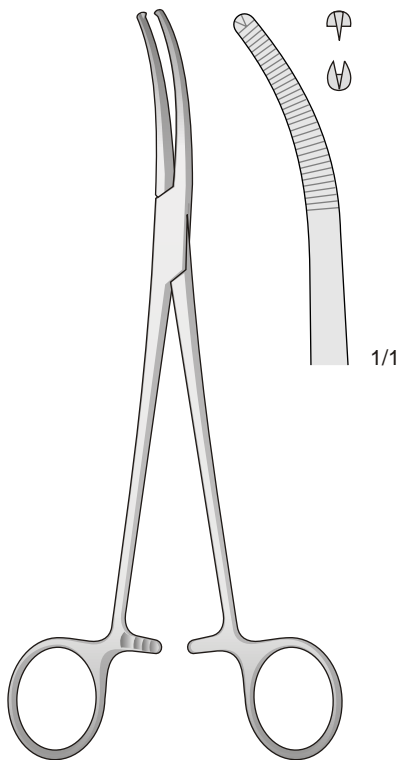

MIKULICZ
05-1220
190 mm

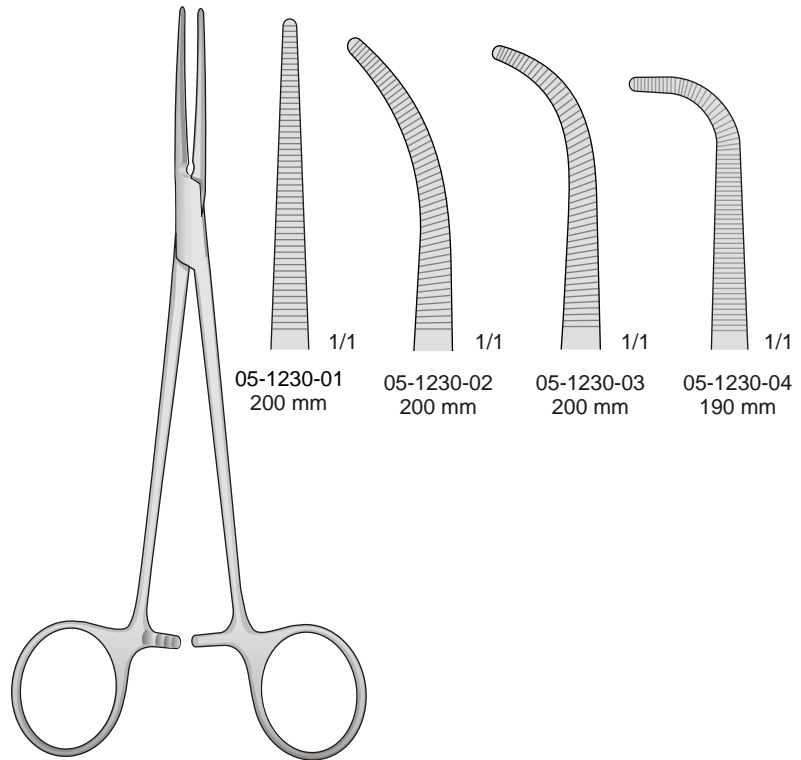

HEISS
05-1230

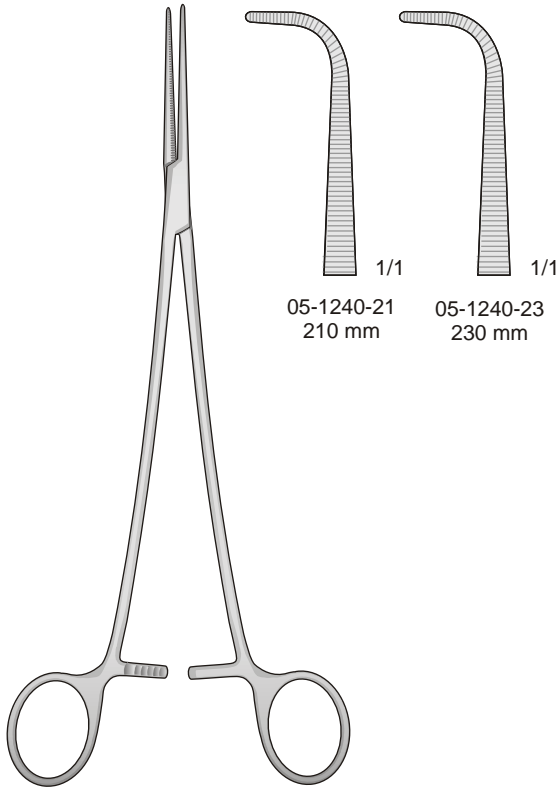

BENGOLEA
05-1240

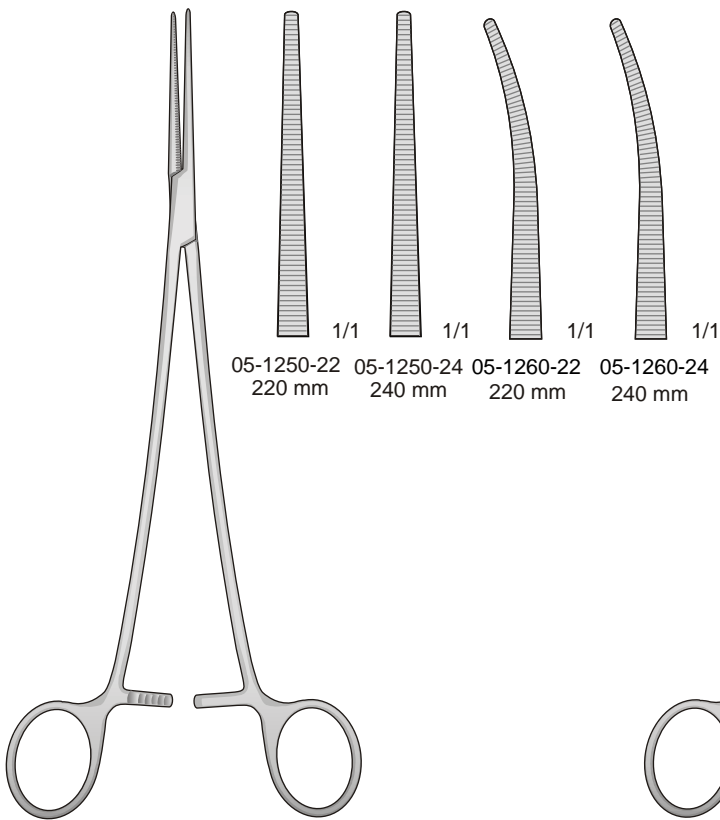

BENGOLEA
05-1250

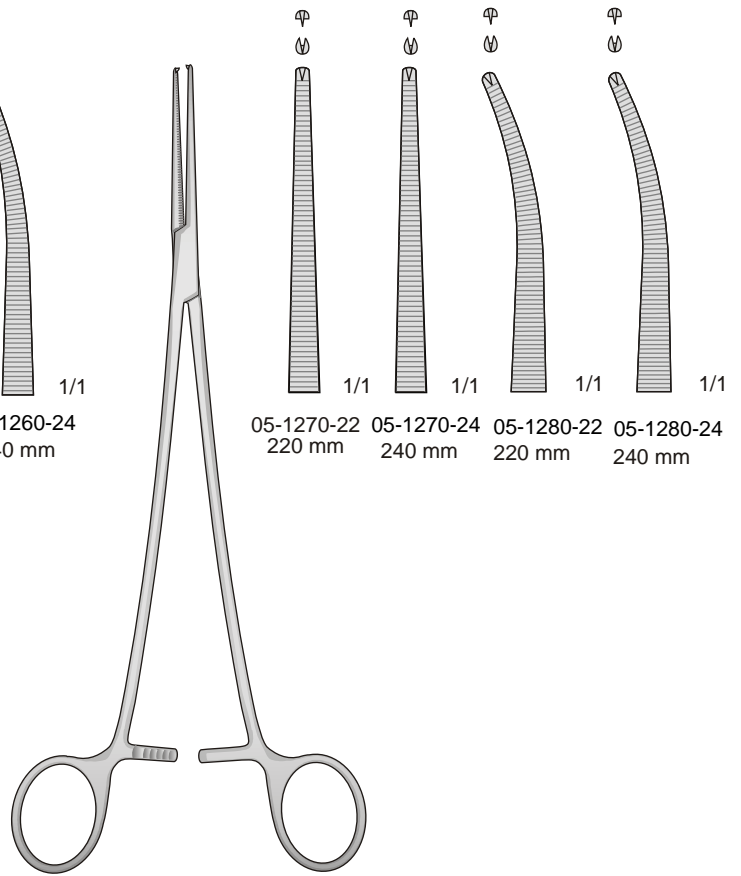

BENGOLEA
05-1270

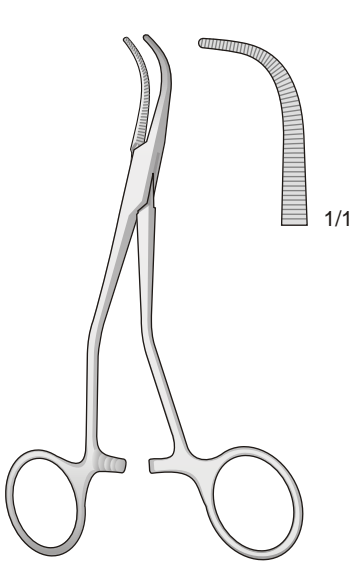

05-1290-13
130 mm

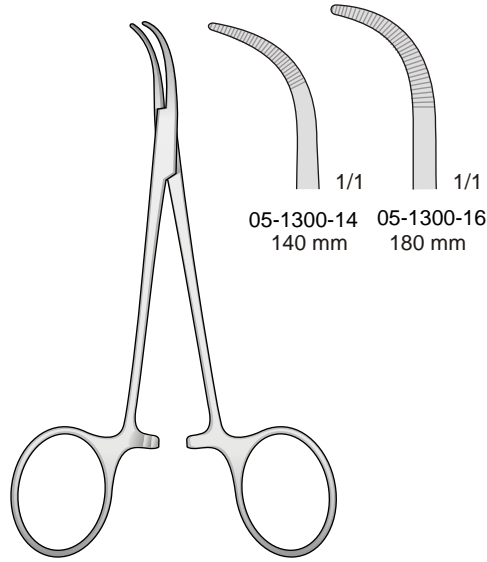

BABY-MIXTER
05-1300

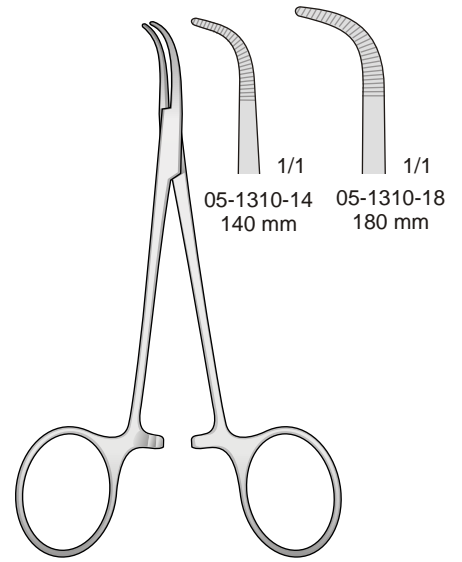

BABY-ADSON
05-1310

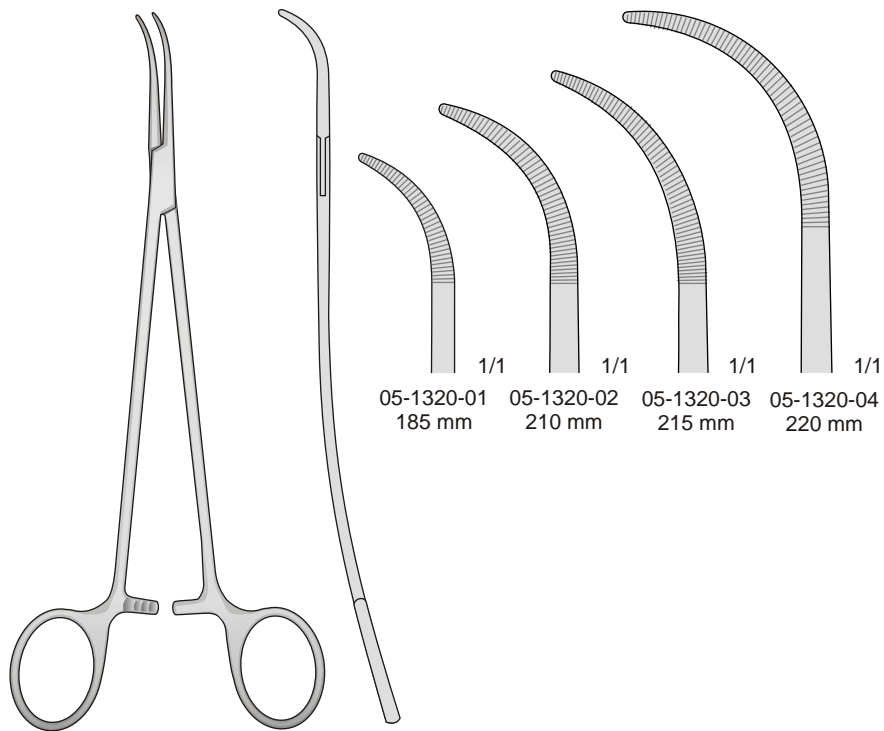

05-1320

Passafili

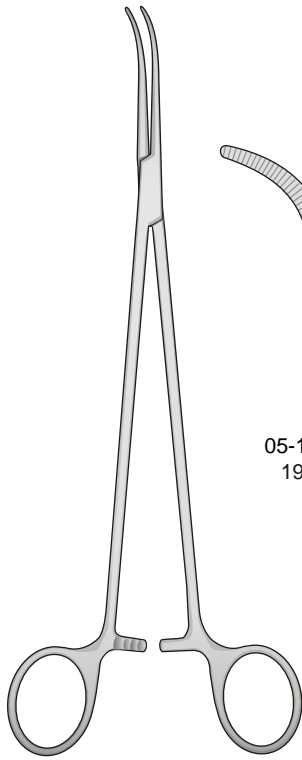

OVERHOLT-GEISSENDORFER
05-1330

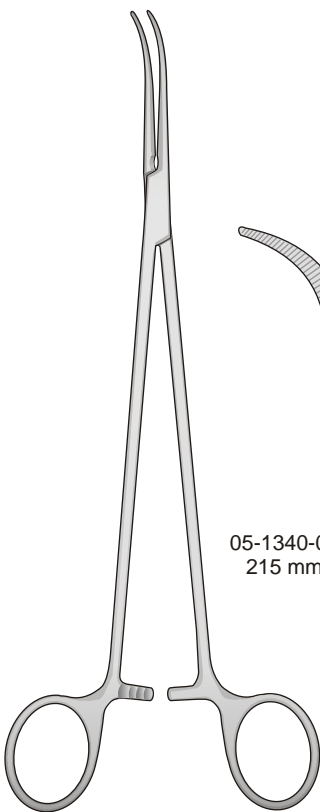
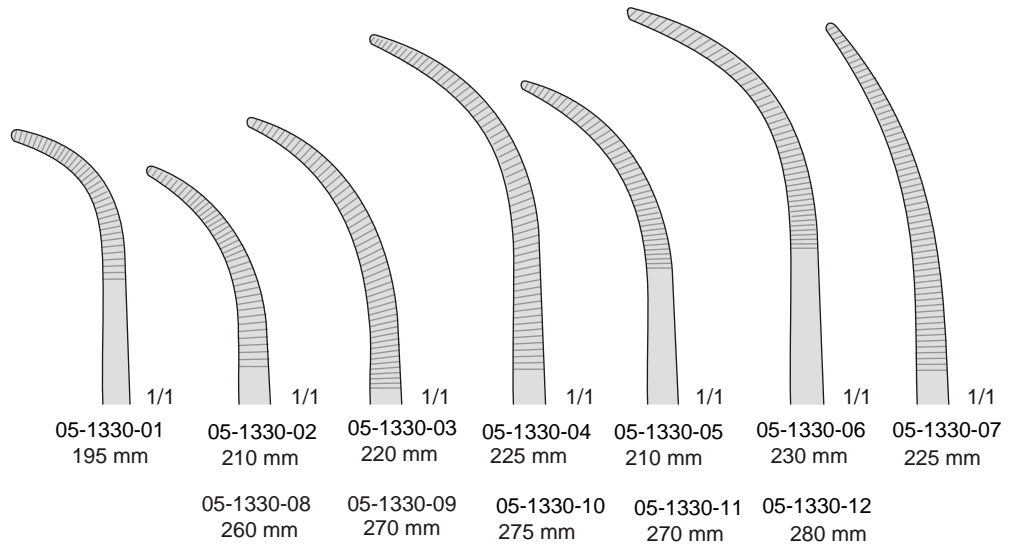

OVERHOLT
05-1340

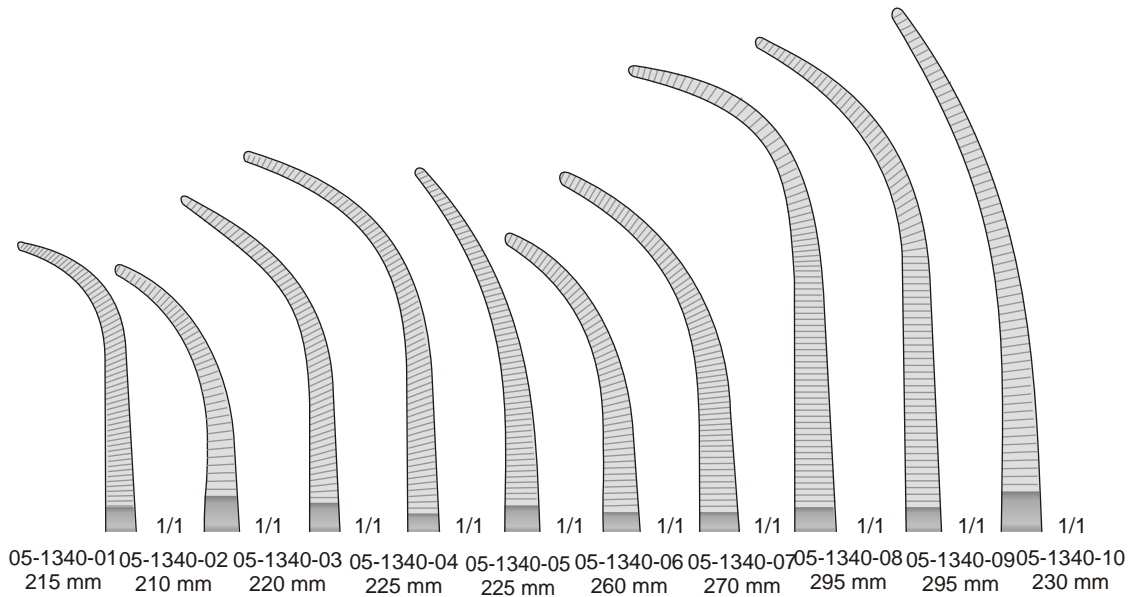

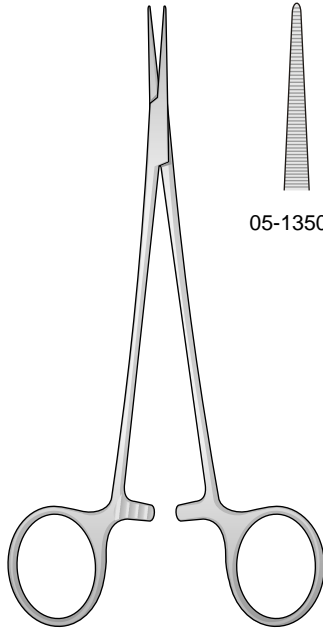

05-1350-16
160 mm

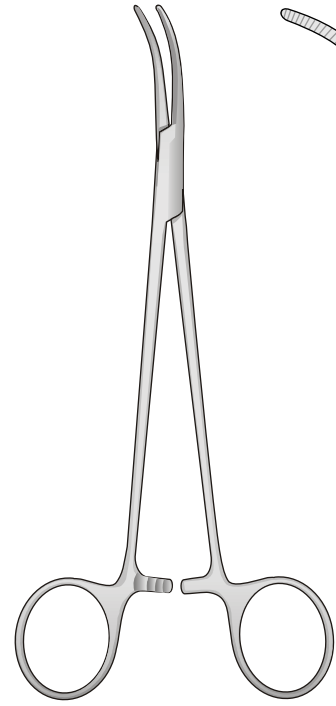
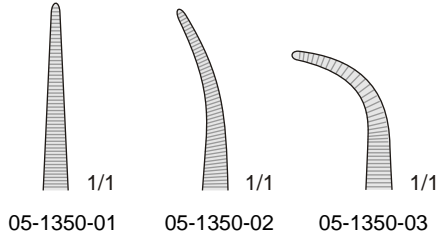

ROCHESTER-PEAN
05-1360
180 mm

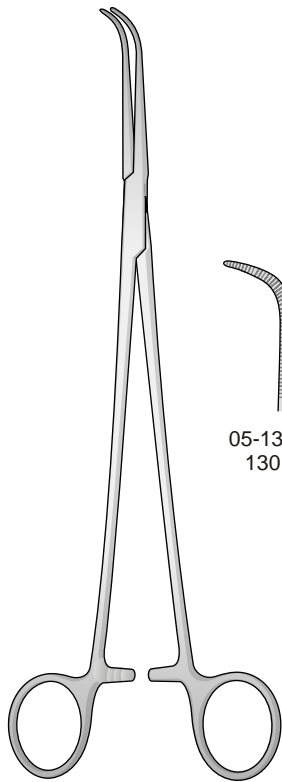
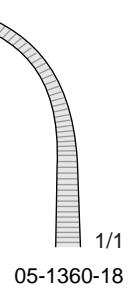

GEMINI
05-1370

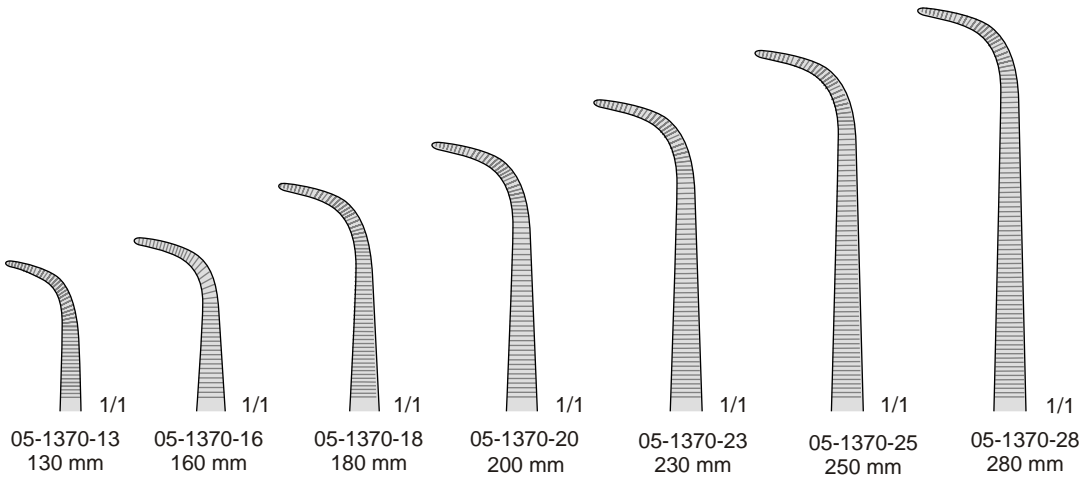

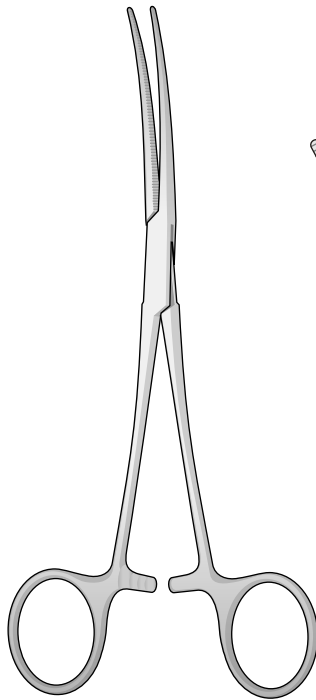

CRAFOORD
05-1380

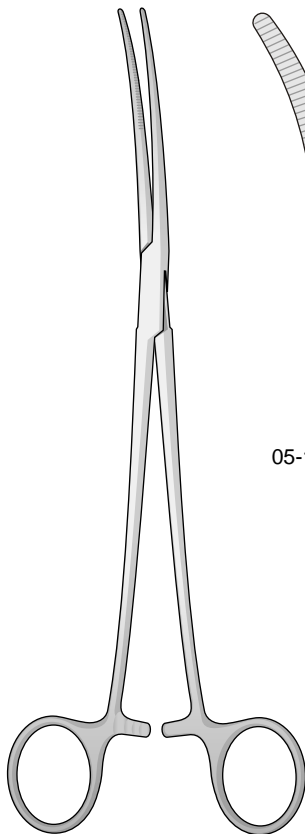
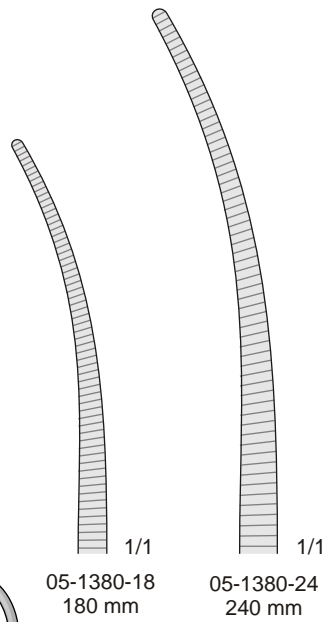

RUMEL
05-1390
240 mm

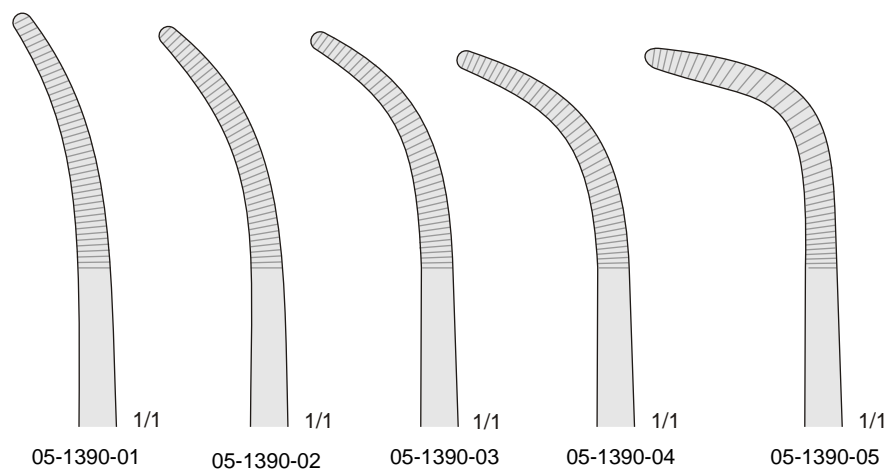

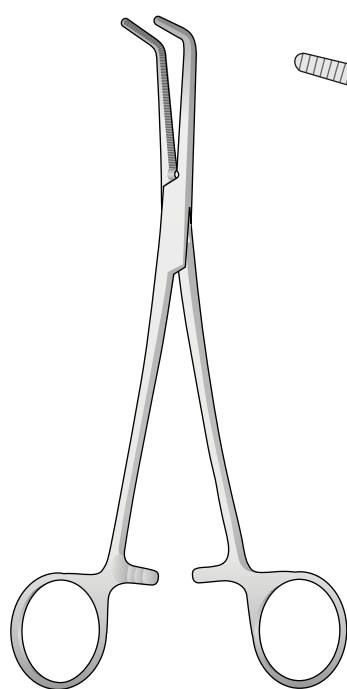

MIXTER
05-1400

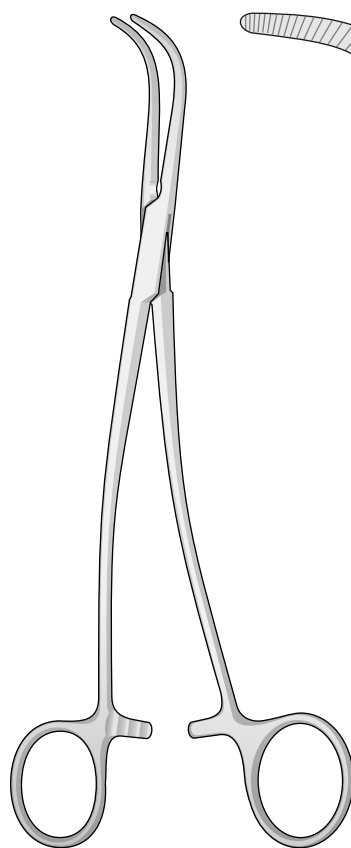
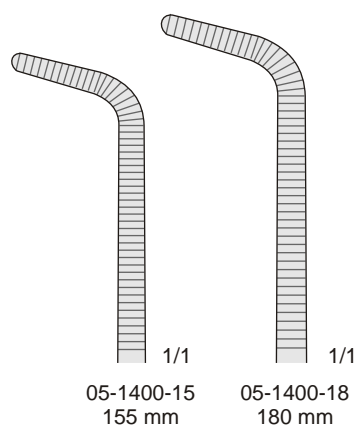

GRAY
05-1410
220 mm

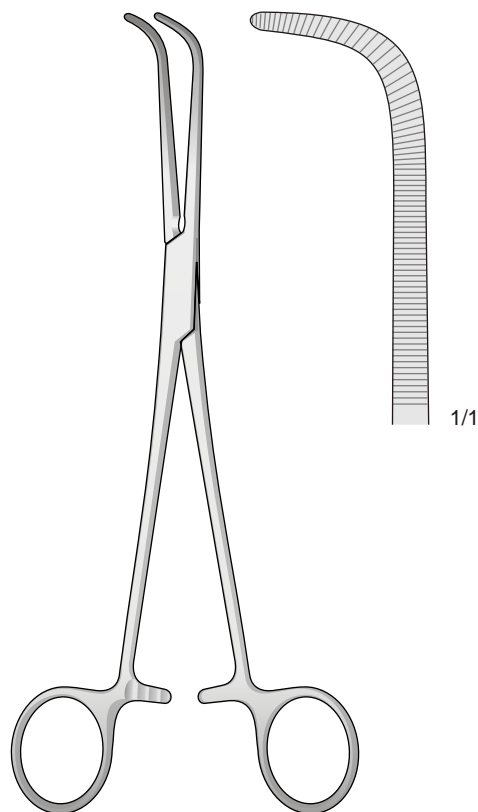
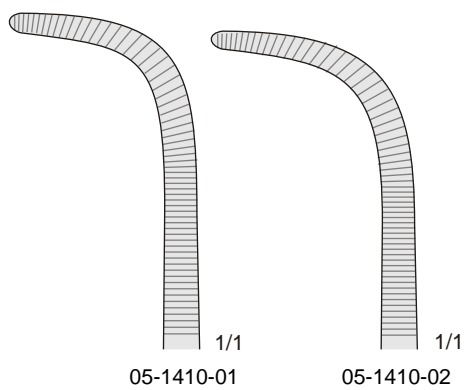

WIKSTROEM
05-1420
205 mm

Pinze per tonsille
Tonsil forceps
Tonsillenklemmen
Pinces pour amygdales
Pinzas para amígdalas

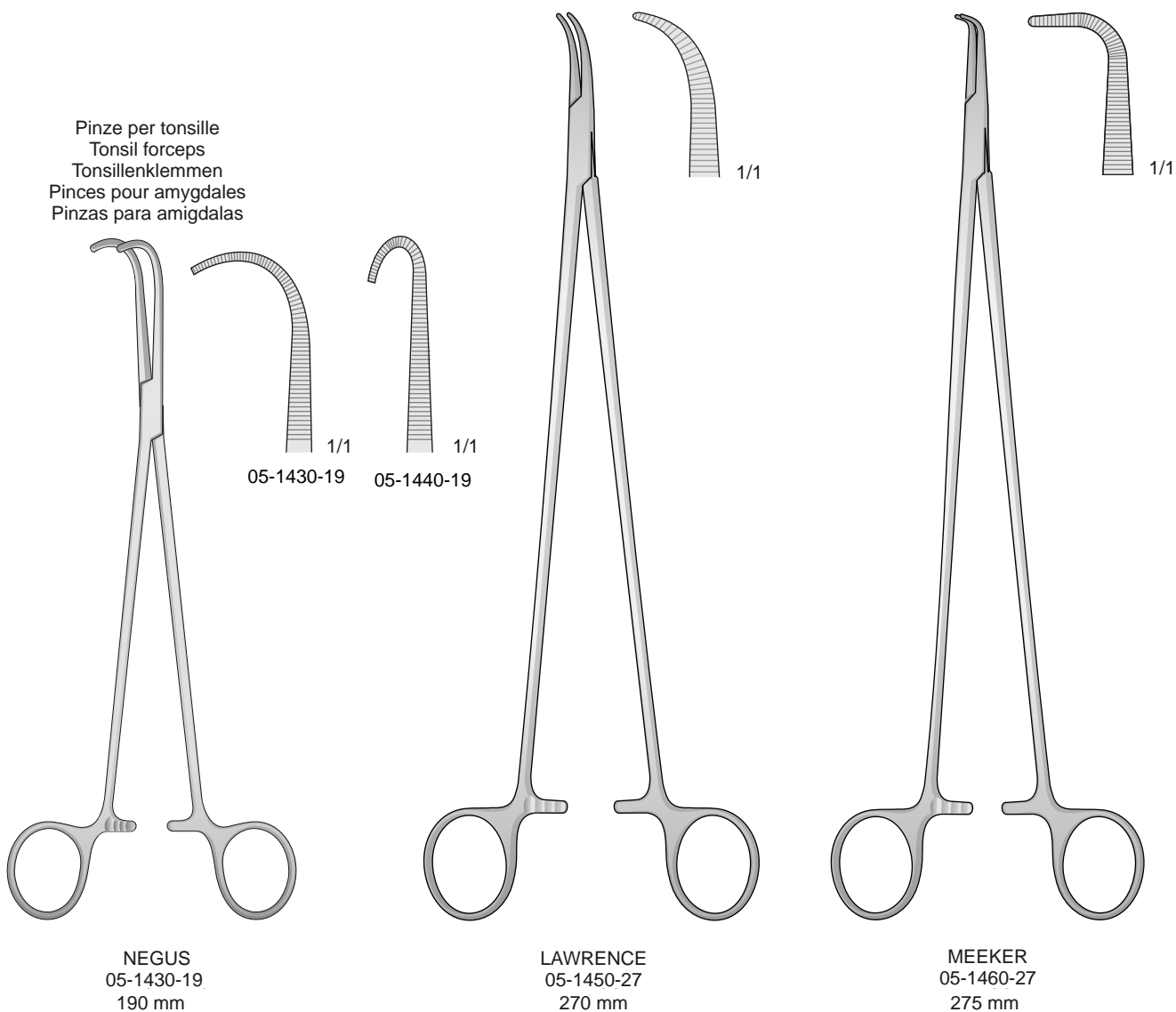

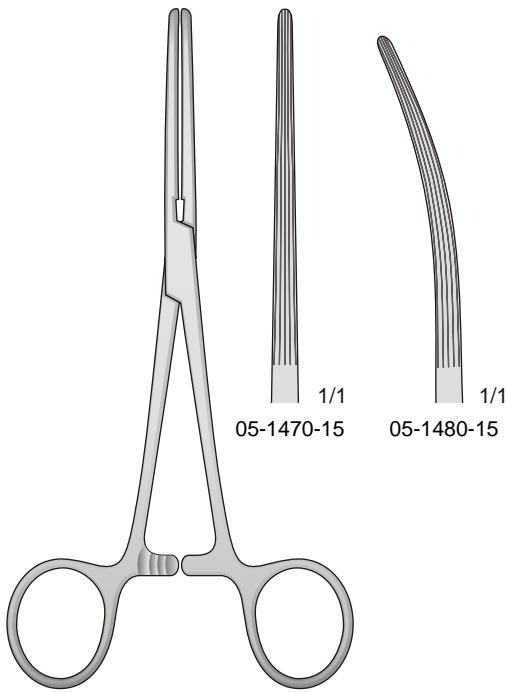

BAINBRIDGE
05-1470
150 mm

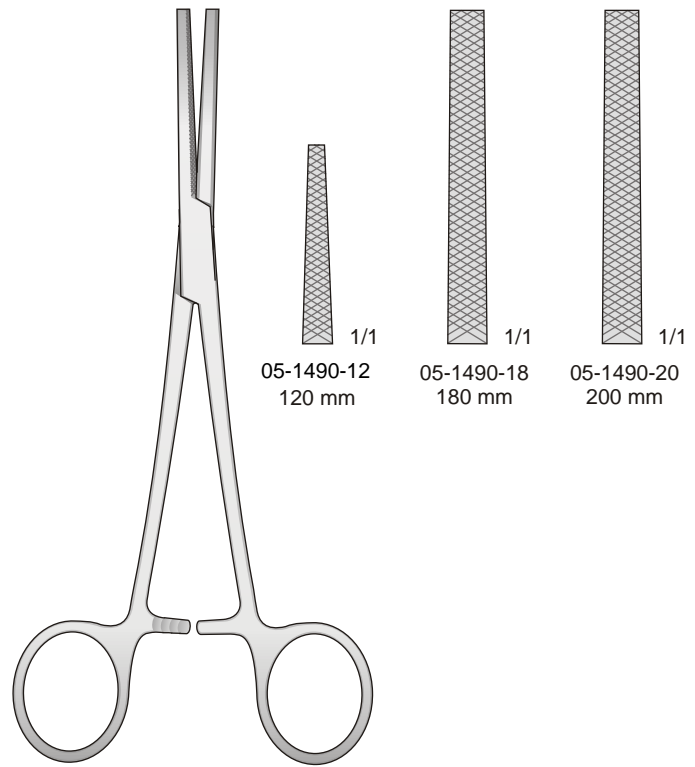

05-1490

Angiotribo - Druckklemmen
Angiotribes - Pinzas-clamps para presión progresiva

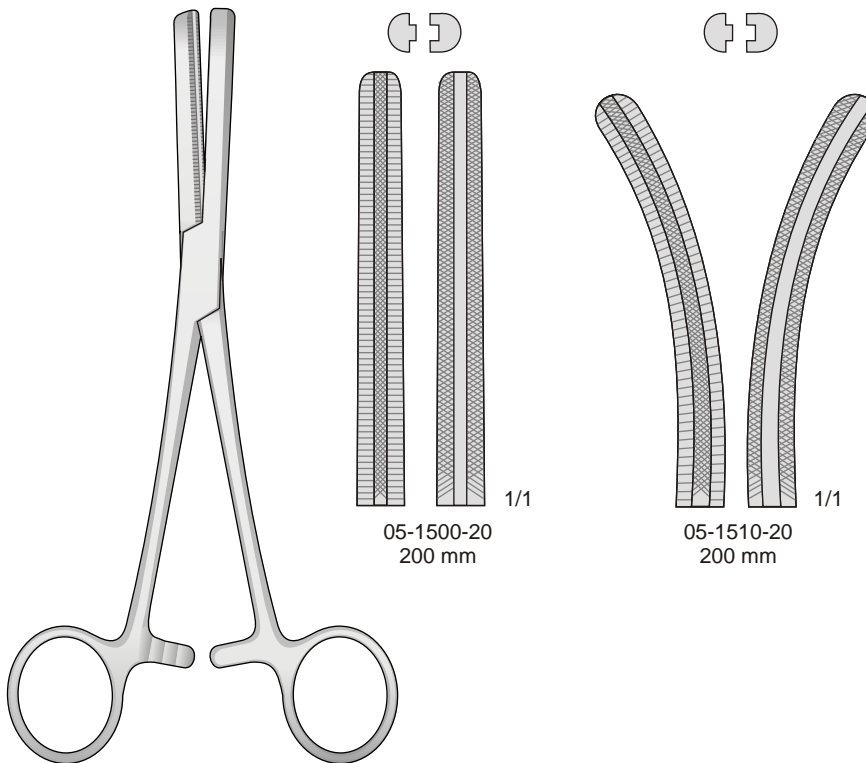

FERGUSON
05-1500

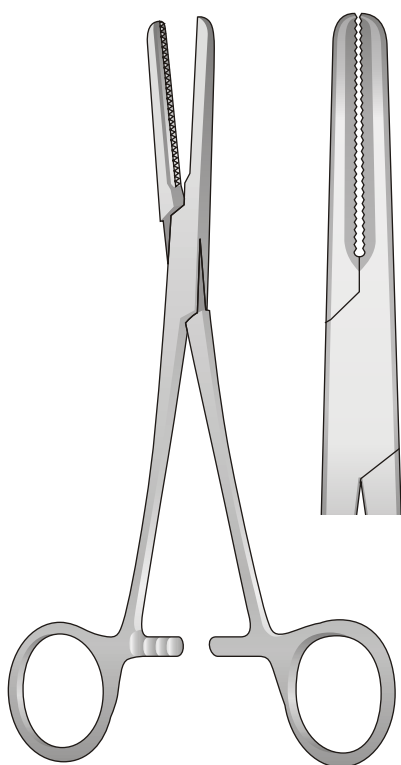

05-1520

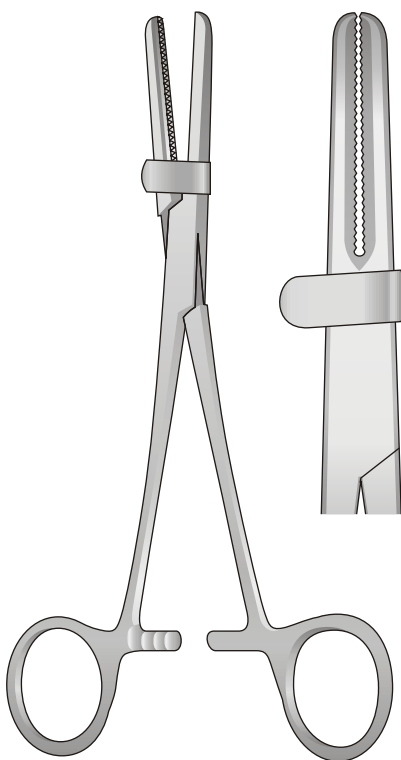
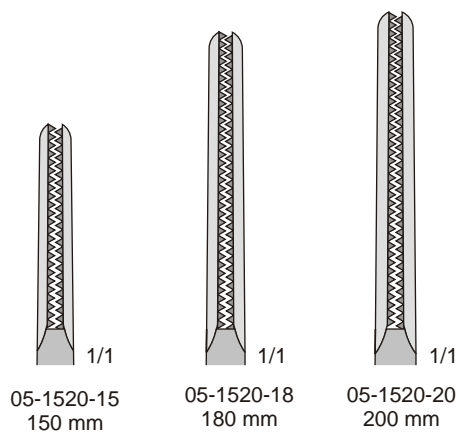

05-1530

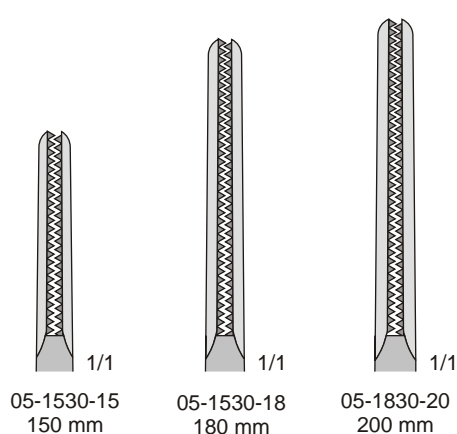

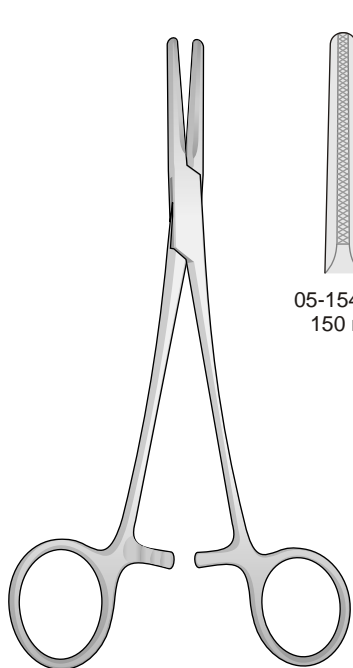

05-1540

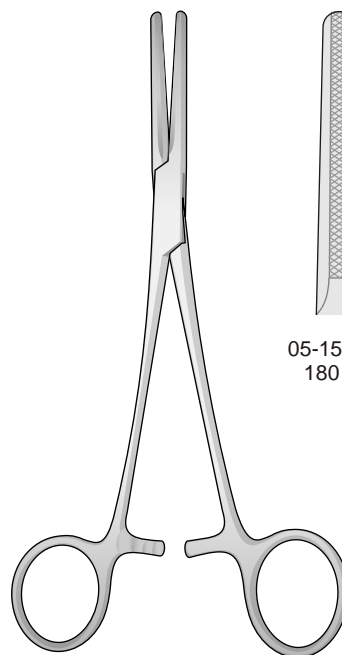
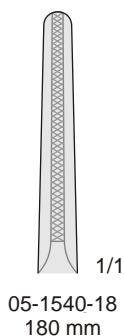
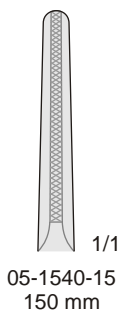

05-1550
180 mm

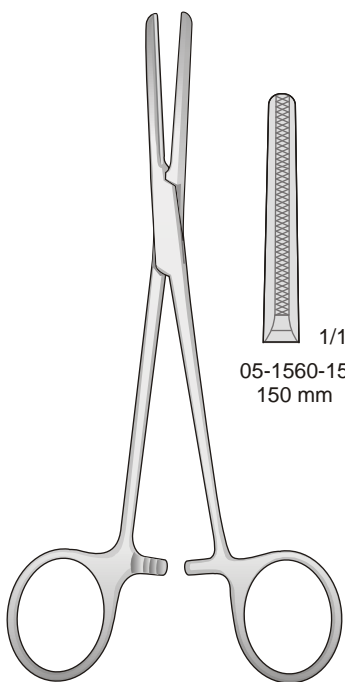
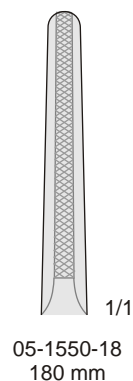

05-1560

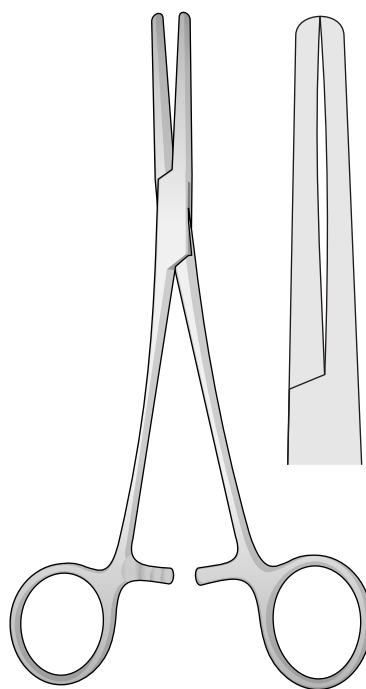
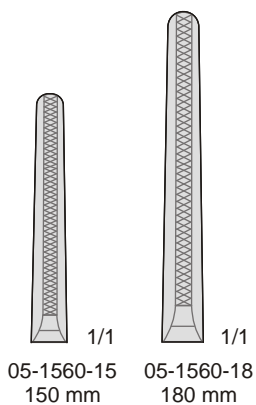

05-1570

