

GYNECOLOGY | UROLOGY

Gynäkologie | Urologie

Gynécologie | Urologie

Ginecología | Urología

Ginecologia | Urologia

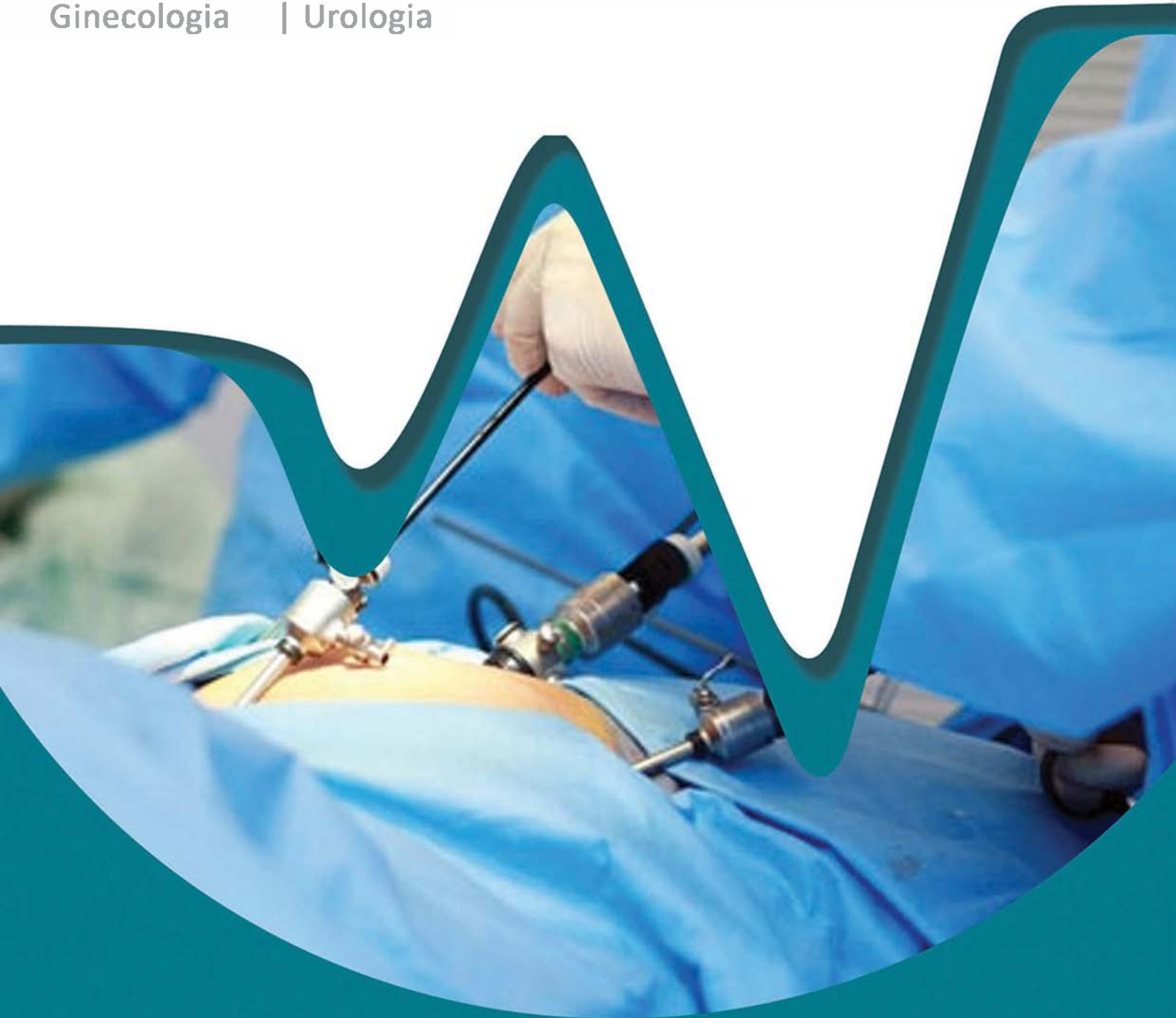

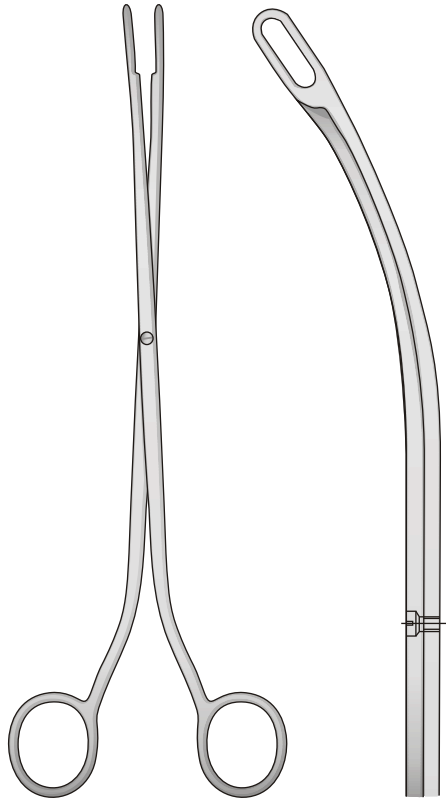

DESJARDINS

15-100
225 mm

Fig. 1



15-100-01

Fig. 3



15-100-02

Fig. 2



15-110-03

Fig. 4



15-110-04

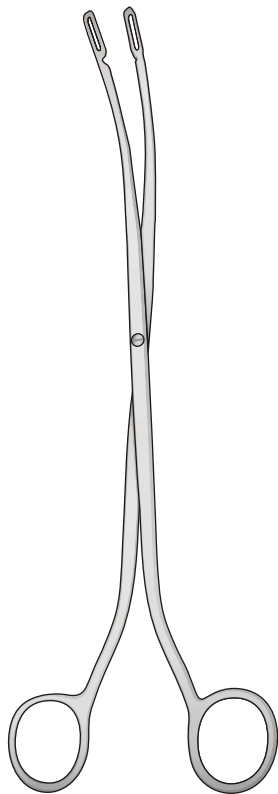

RANDALL

15-110
225 mm

Fig. 1

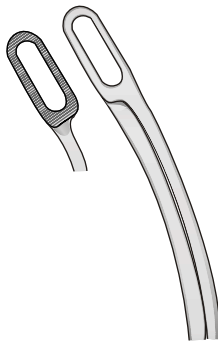

15-110-01

Fig. 3



15-110-02

Fig. 2



15-110-03

Fig. 4



15-110-04

Per uomini
For men
Für Männer
Pour hommes
Para hombres

Charr.	
15-120-08	8
15-120-10	10
15-120-12	12
15-120-14	14
15-120-16	16
15-120-18	18
15-120-20	20

Ø 2,7 mm

Ø 3 mm

Per donne
For woman
Für Frauen
Pour femmes
Para mujeres

Charr.	
15-130-06	6
15-130-08	8
15-130-10	10
15-130-12	12
15-130-14	14
15-130-16	16
15-130-18	18

Ø 1,2 mm

Ø 3 mm

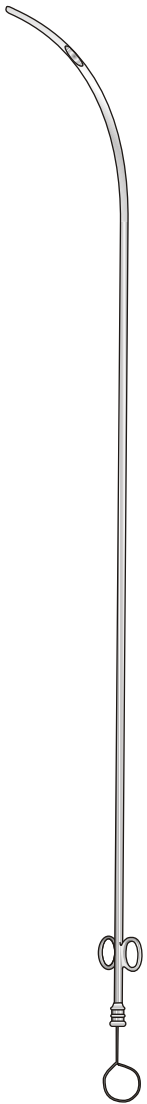

15-120
290 mm



15-130
160 mm

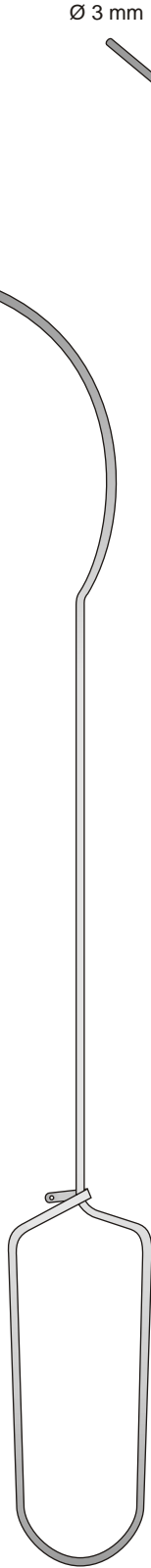

GUYON
15-140-36
365 mm

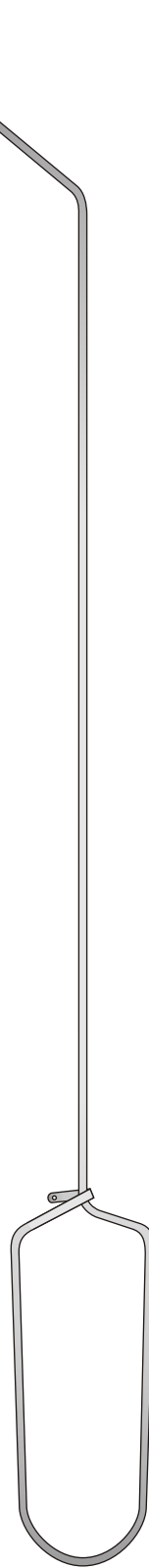

BENIQUE
15-140-41
410 mm

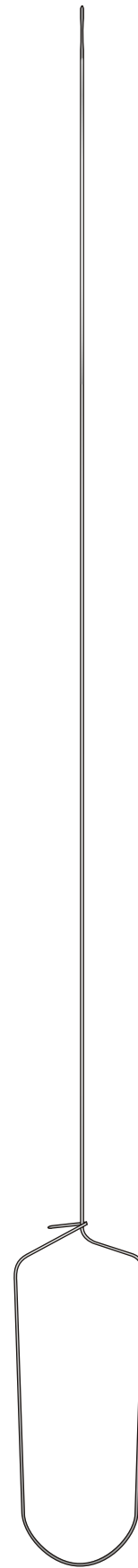

15-150-46
460 mm

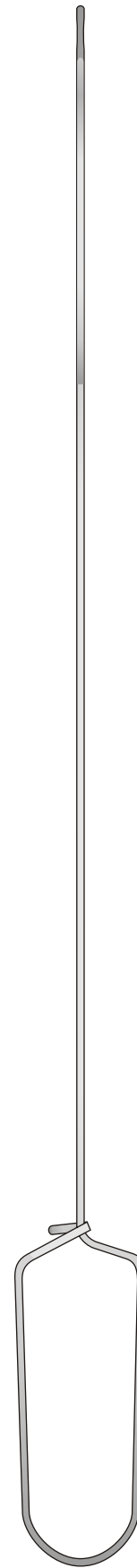

15-160-46
460 mm

15-170-01 - 190 mm - Ø 3 mm
15-170-02 - 190 mm - Ø 4 mm
15-170-03 - 190 mm - Ø 5 mm
15-170-04 - 190 mm - Ø 6 mm
15-170-05 - 190 mm - Ø 7 mm
15-170-06 - 190 mm - Ø 8 mm
15-170-07 - 190 mm - Ø 9 mm
15-170-08 - 190 mm - Ø 10 mm
15-170-09 - 190 mm - Ø 11 mm

15-190-01 - 300 mm - Ø 1 mm
15-190-02 - 300 mm - Ø 2 mm
15-190-03 - 300 mm - Ø 3 mm
15-190-04 - 300 mm - Ø 4 mm
15-190-05 - 300 mm - Ø 5 mm
15-190-06 - 300 mm - Ø 6 mm
15-190-07 - 300 mm - Ø 7 mm
15-190-08 - 300 mm - Ø 8 mm
15-190-09 - 300 mm - Ø 9 mm
15-190-10 - 300 mm - Ø 10 mm
15-190-11 - 300 mm - Ø 11 mm
15-190-12 - 300 mm - Ø 12 mm
15-190-13 - 300 mm - Ø 13 mm

15-180
Set completo di 9 pezzi
con custodia

15-200
Set completo di
13 pezzi



BAKES
15-170

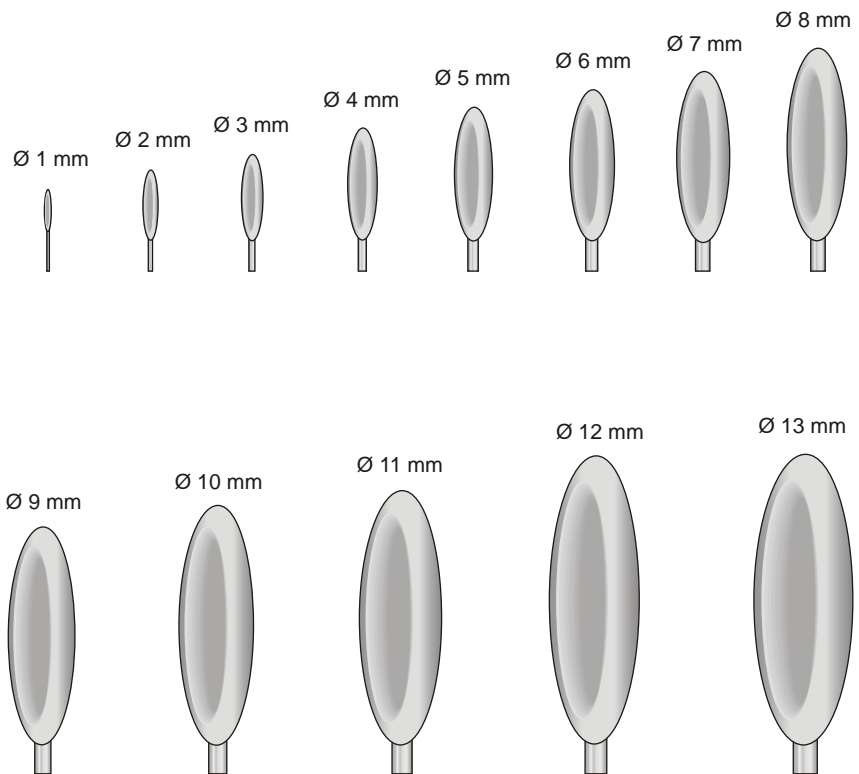

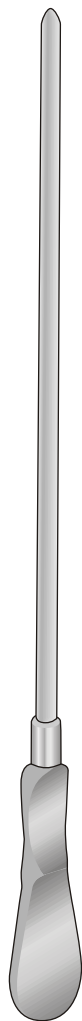

DITTEL
15-210
220 mm

Charr.

15-210-08	8
15-210-09	9
15-210-10	10
15-210-11	11
15-210-12	12
15-210-14	14
15-210-16	16
15-210-18	18
15-210-20	20
15-210-22	22
15-210-24	24
15-210-25	25
15-210-26	26
15-210-27	27
15-210-28	28
15-210-29	29
15-210-30	30

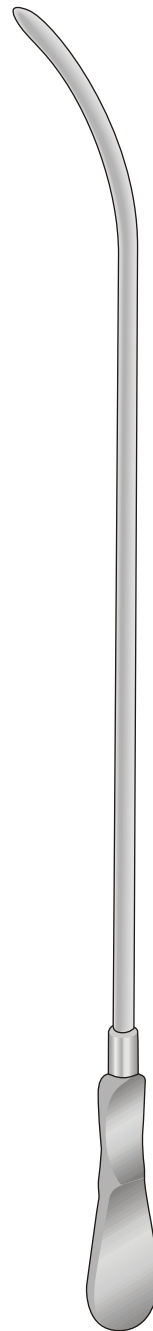

DITTEL
15-220
345 mm

Charr.

15-210-08	8
15-210-09	9
15-210-10	10
15-210-11	11
15-210-12	12
15-210-13	13
15-210-14	14
15-210-15	15
15-210-16	16
15-210-17	17
15-210-18	18
15-210-19	19
15-210-20	20
15-210-21	21
15-210-22	22
15-210-23	23
15-210-24	24
15-210-25	25
15-210-26	26
15-210-27	27
15-210-28	28
15-210-29	29
15-210-30	30

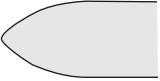
15-230-01 - Ø 10 mm  1/1

15-230-02 - Ø 9 mm  1/1

15-230-03 - Ø 8 mm  1/1

15-230-04 - Ø 7 mm  1/1

15-230-05 - Ø 6 mm  1/1

15-230-06 - Ø 5 mm  1/1

15-230-07 - Ø 4 mm  1/1

15-230-08 - Ø 3 mm  1/1

15-230
190 mm

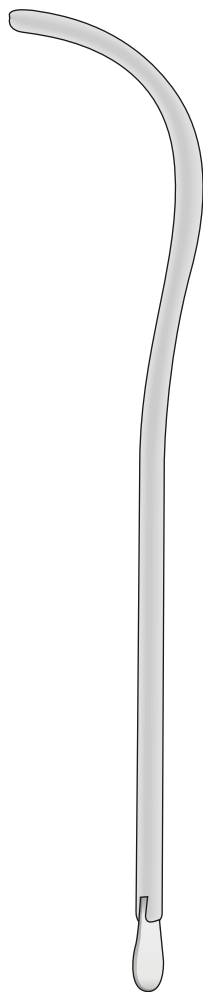

GUYON
15-240
255 mm

	Ben.	Charr.
15-240-01	24	12
15-240-02	26	13
15-240-03	28	14
15-240-04	30	15
15-240-05	32	16
15-240-06	34	17
15-240-07	36	18
15-240-08	38	19
15-240-09	40	20
15-240-10	42	21
15-240-11	44	22
15-240-12	46	23
15-240-13	48	24
15-240-14	50	25
15-240-15	52	26
15-240-16	54	27
15-240-17	56	28
15-240-18	58	29
15-240-19	60	30

Sonde per dotto biliare, Elastiche
Gall Stone Probes, Elastic
Gallensteinsonden, Federnd
Explorateurs pour calculs biliaires, Élastiques
Exploradores para cálculos biliares, Elásticos

Ø 4,3 mm

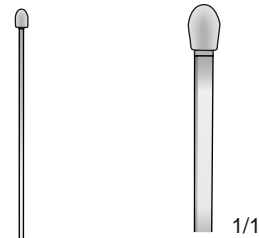

15-250-01

Ø 6,0 mm

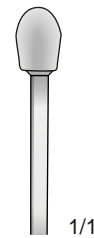

15-250-02

Ø 7,0 mm

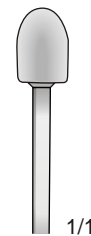

15-250-03



DESJARDINS
15-250
280 mm

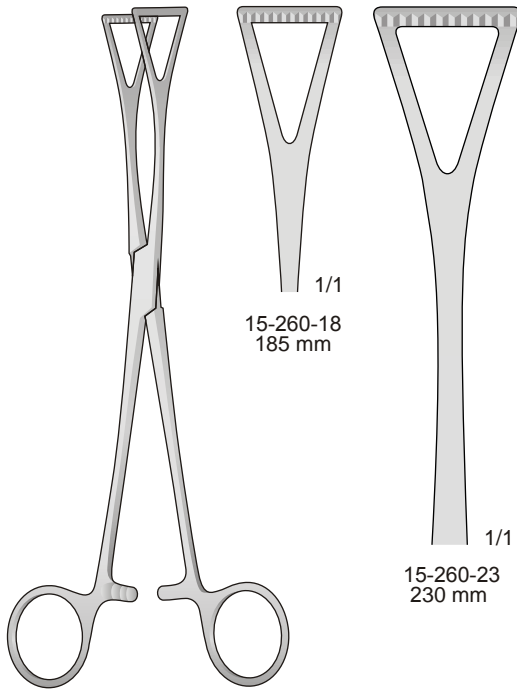

DUVAL
15-260

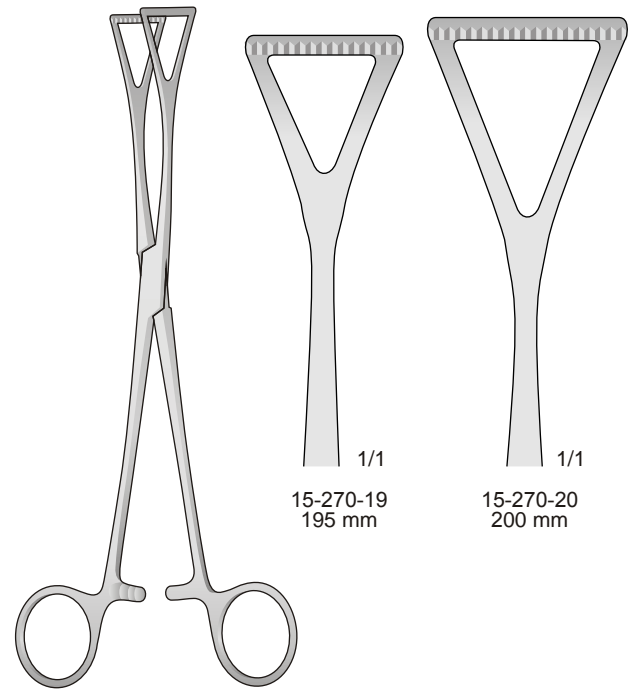

DUVAL-COLLIN
15-270

Pinze per peduncoli renali - Kidney pedicle clamp forceps - Nierenstielklemmen
Pincas-clamps pour pédicules rénaux - Pinzas-clamps para pedúnculos renales

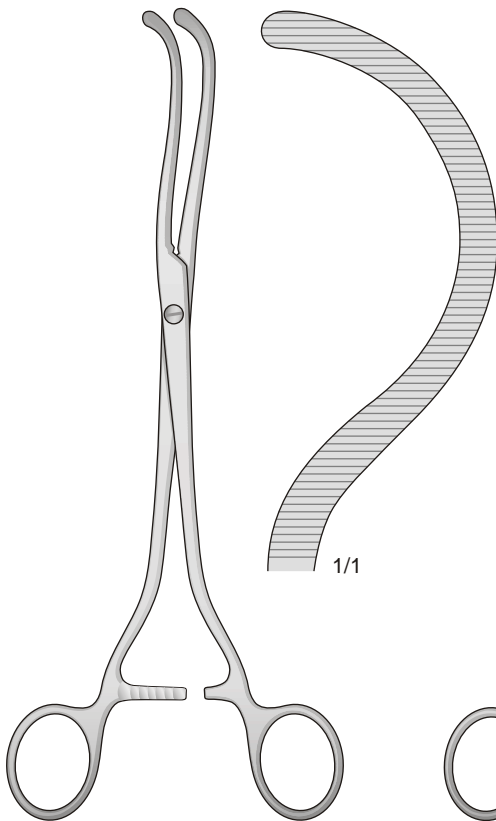

BRAUN
15-280-24
245 mm

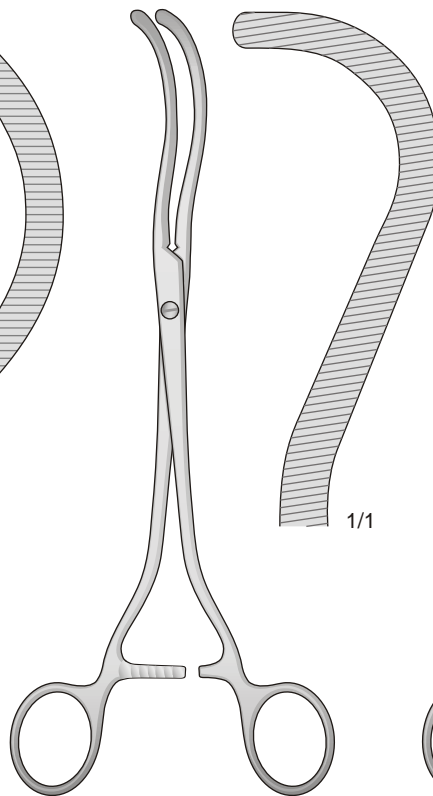

GUYON
15-290-23
235 mm

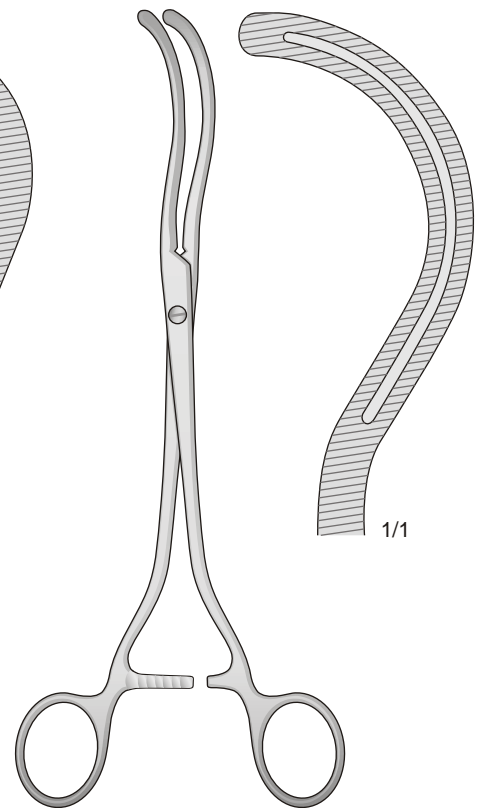

STILLE
15-300-19
240 mm

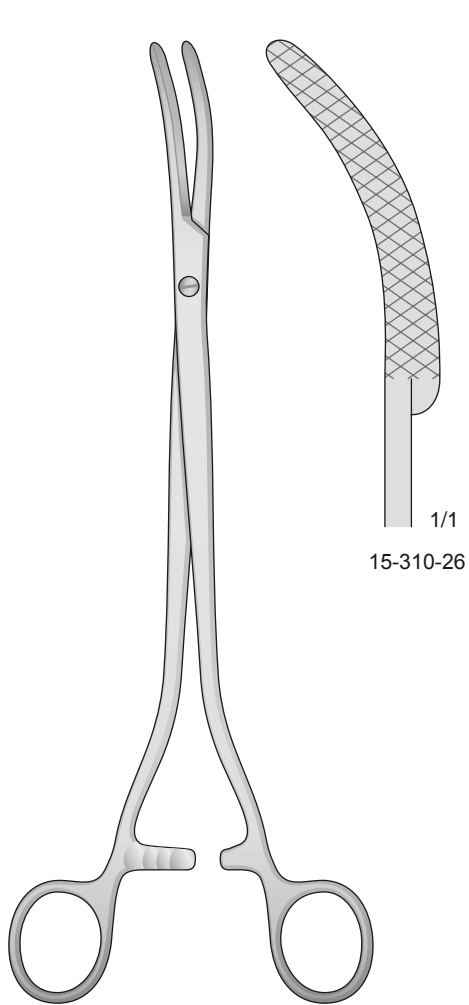

WERTHEIM
15-310-26
260 mm

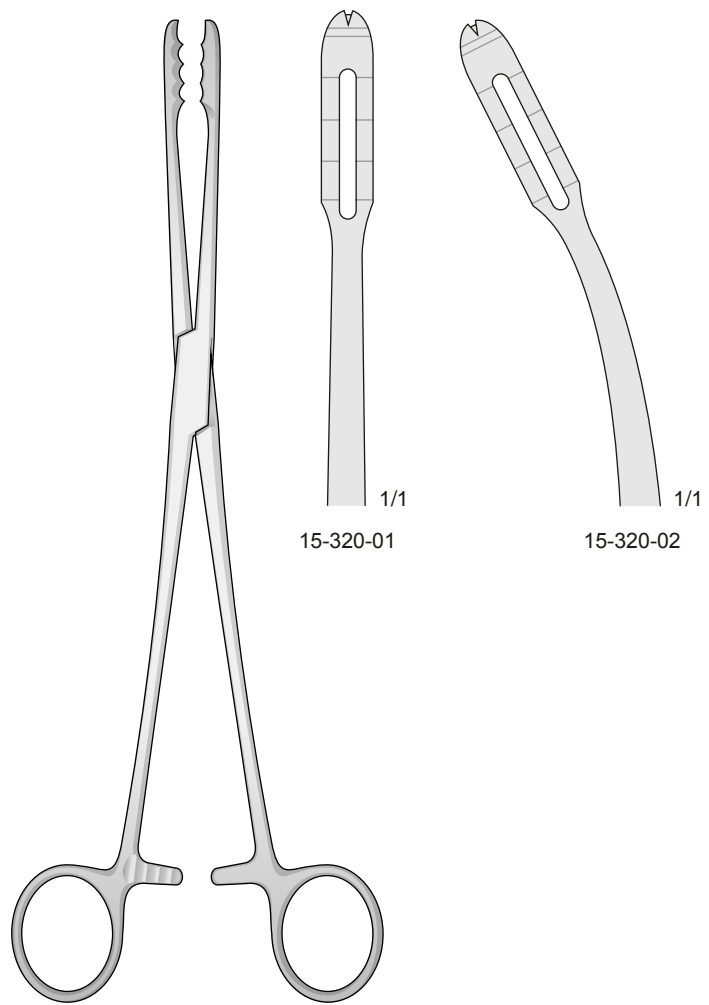

15-320
265 mm

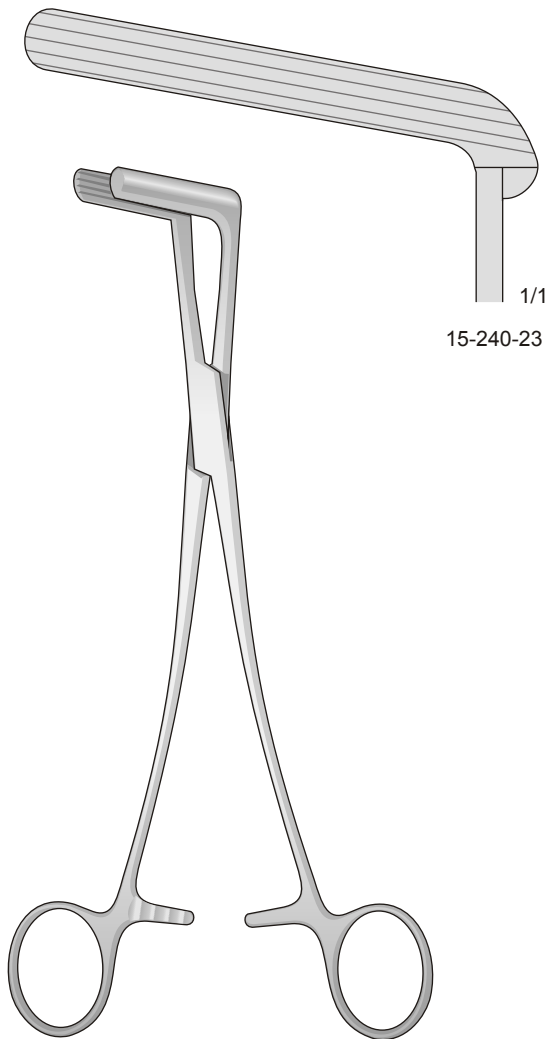

1/1
15-240-23

WERTHEIM
15-240
235 mm

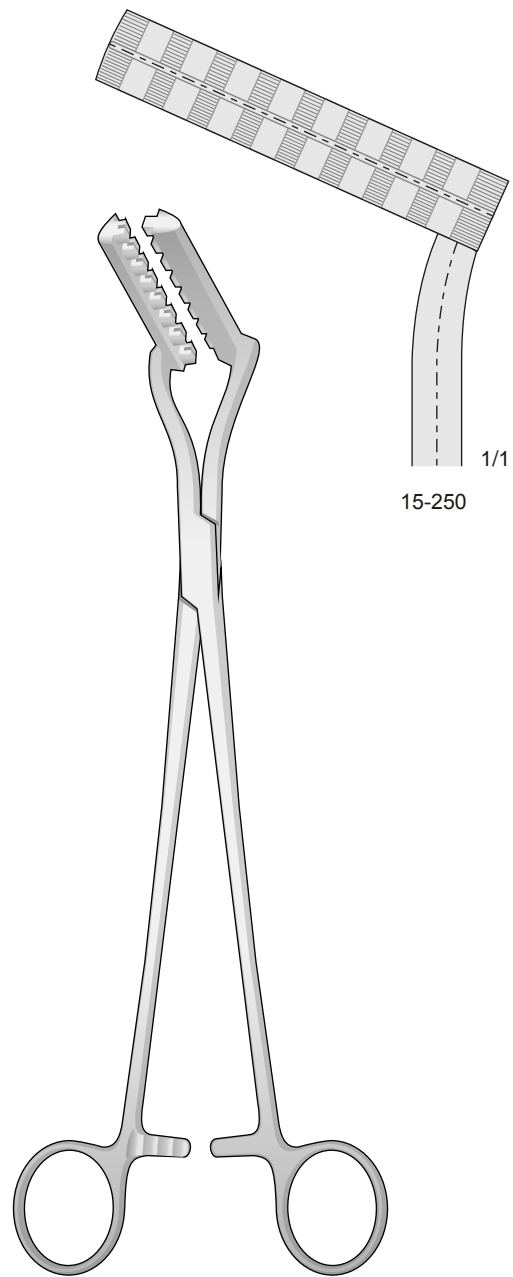

1/1
15-250

15-250
280 mm

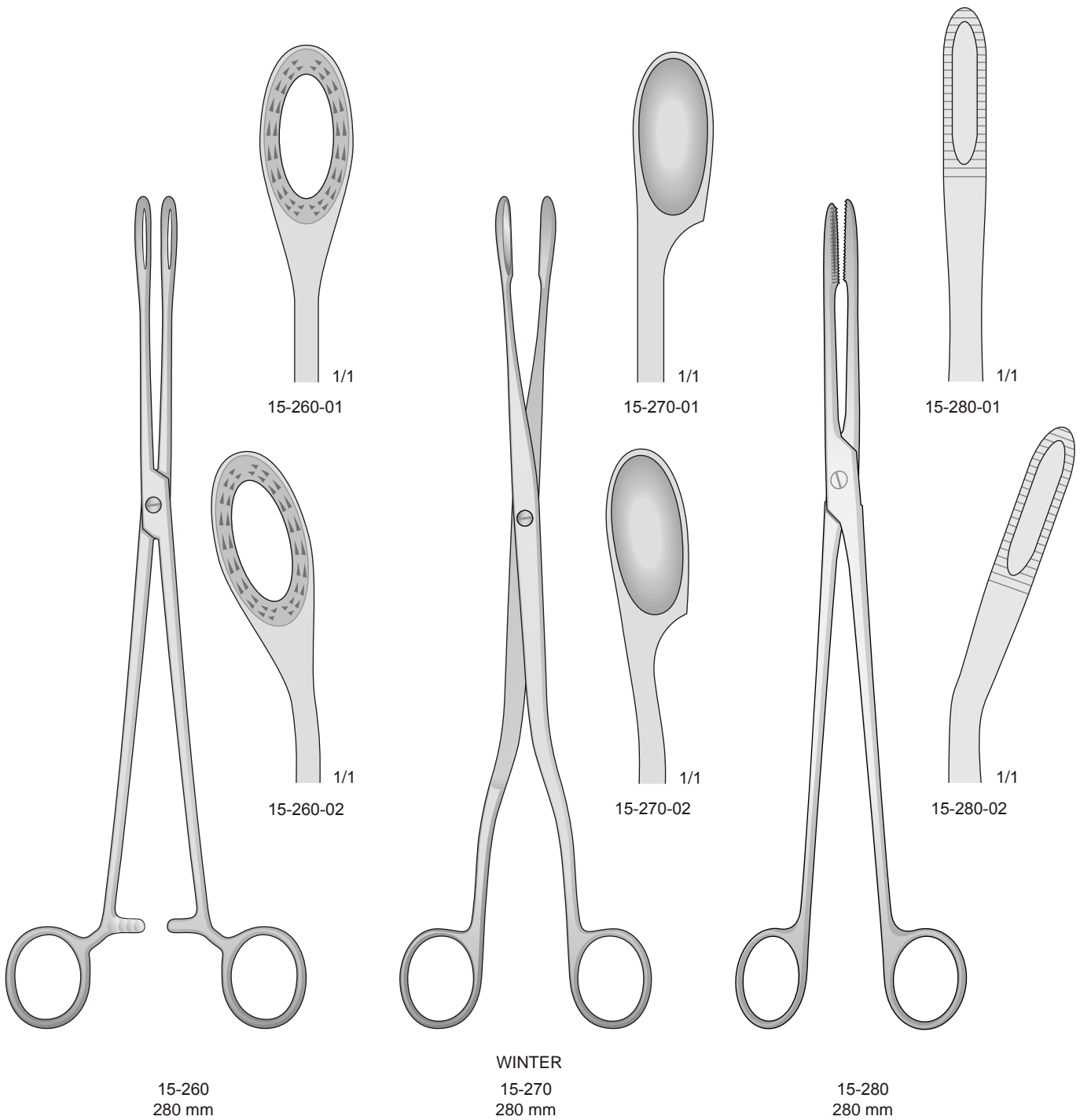

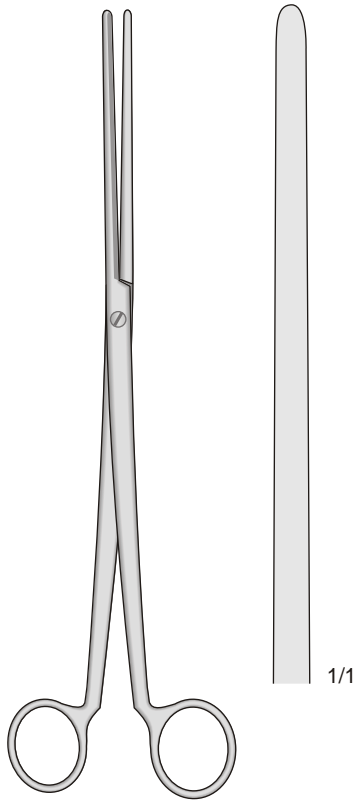

COLLIN
15-290-26
260 mm

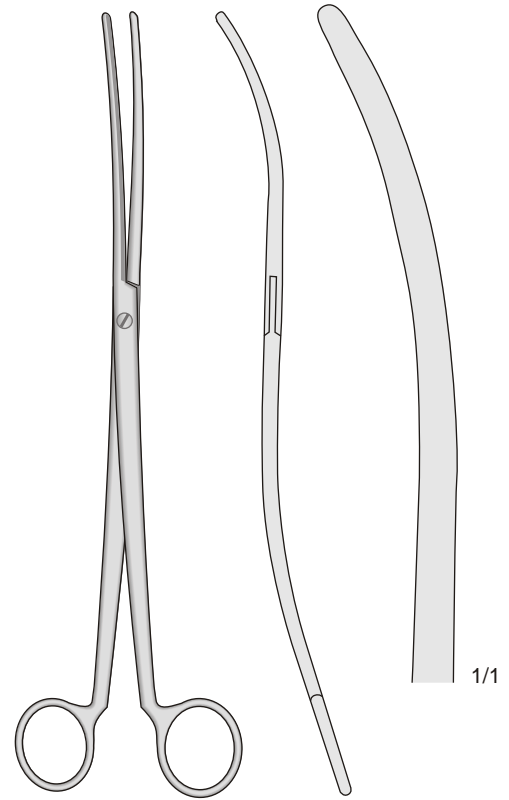

COLLIN
15-300-26
260 mm

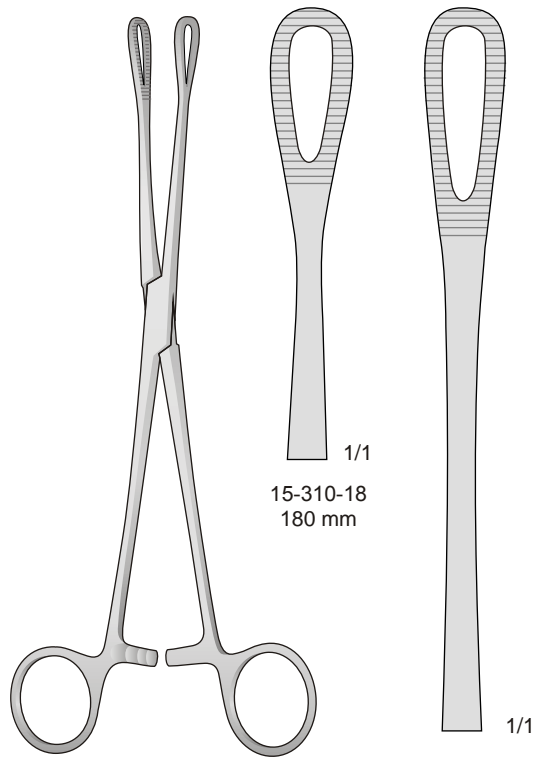

RAMPLEY
15-310

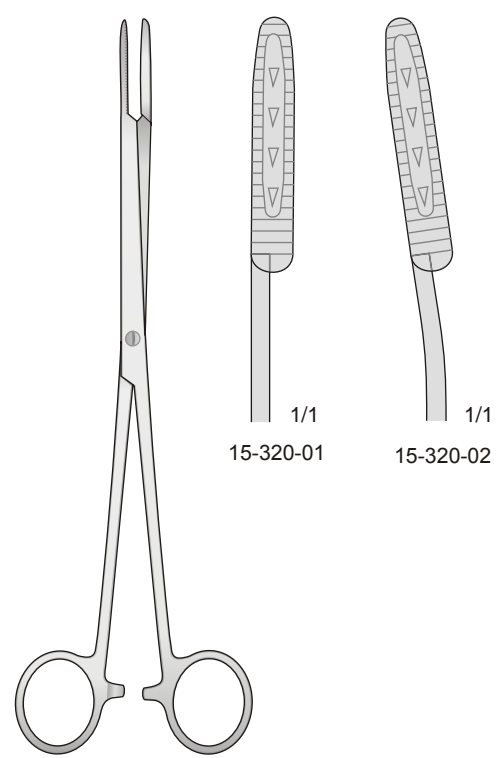
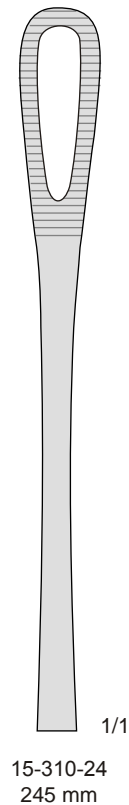
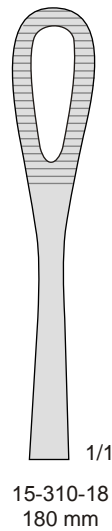

MAIER
15-320
245 mm



KALLMORGEN
15-330-01 - 70 x 40 mm
170 mm

15-330-02 - 70 x 33 mm
170 mm

15-340
Set 2 pezzi - Set 2 pieces
Set 2 stück - Set 2 pièces
Set 2 piezos
70 x 40 mm
70 x 33 mm

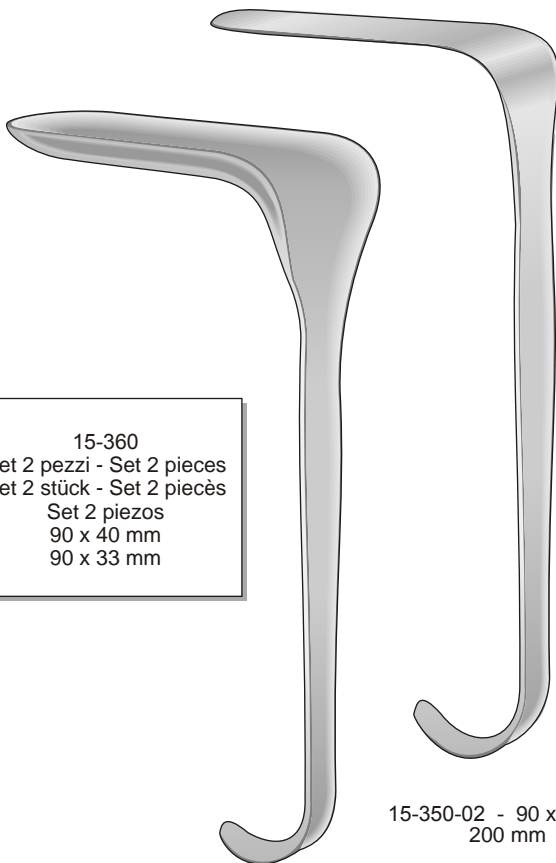

KALLMORGEN
15-350-01 - 90 x 40 mm
200 mm

15-350-02 - 90 x 33 mm
200 mm

15-360
Set 2 pezzi - Set 2 pieces
Set 2 stück - Set 2 pièces
Set 2 piezos
90 x 40 mm
90 x 33 mm

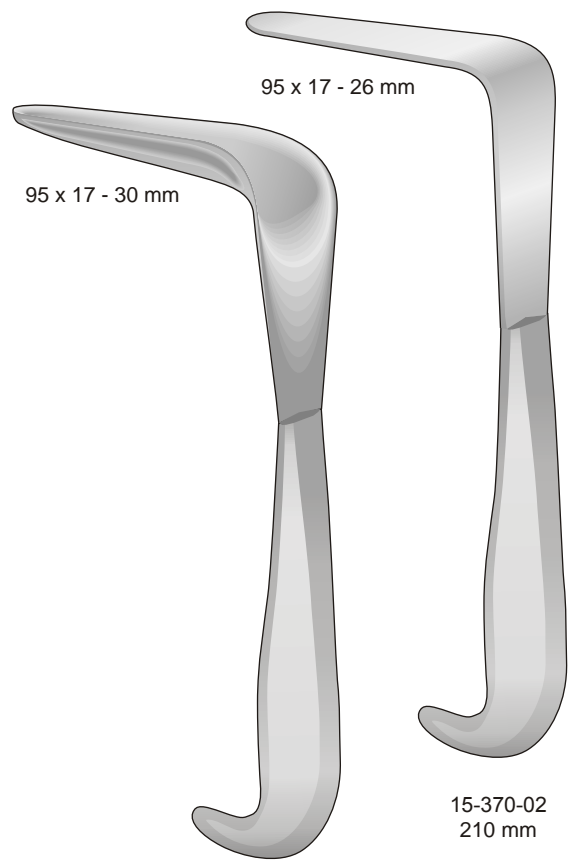

MATHIEU
15-370-01
210 mm

15-370-02
210 mm

95 x 17 - 26 mm

95 x 17 - 30 mm

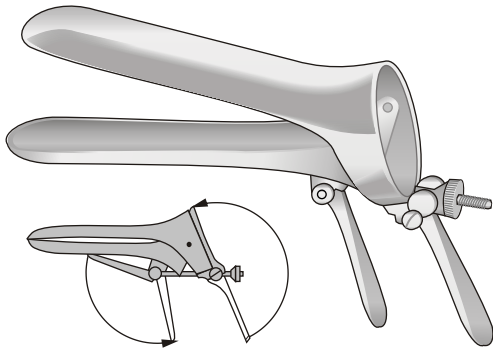

CUSCO
15-380-01 Fig. 0 77x17 mm
15-380-02 Fig. 1 75x33 mm
15-380-03 Fig. 2 86x36 mm
15-380-04 Fig. 3 97x36 mm

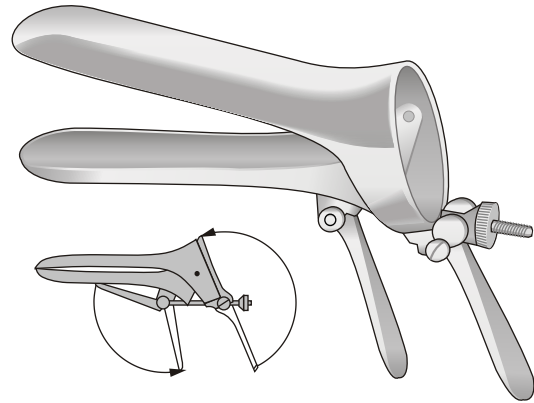

**CUSCO
SCHWEIZER MODELL**
15-390-01 Fig.1 90x23 mm
15-390-01 Fig.2 100x24 mm
15-390-01 Fig.3 105x27 mm

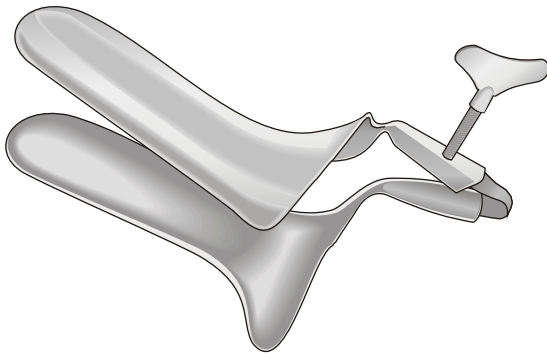

COLLIN-STANDARD
15-400-01 Fig. 1 90x29 mm
15-400-01 Fig. 2 95x35 mm
15-400-01 Fig. 3 110x40 mm

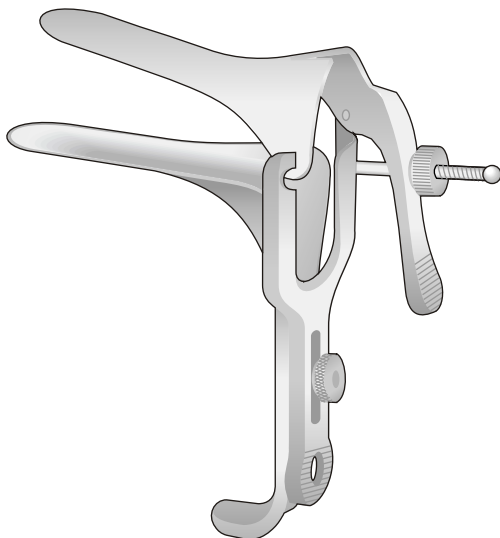

GRAVE
15-410-01 75x20 mm
15-410-02 95x30 mm
15-410-03 105x33 mm

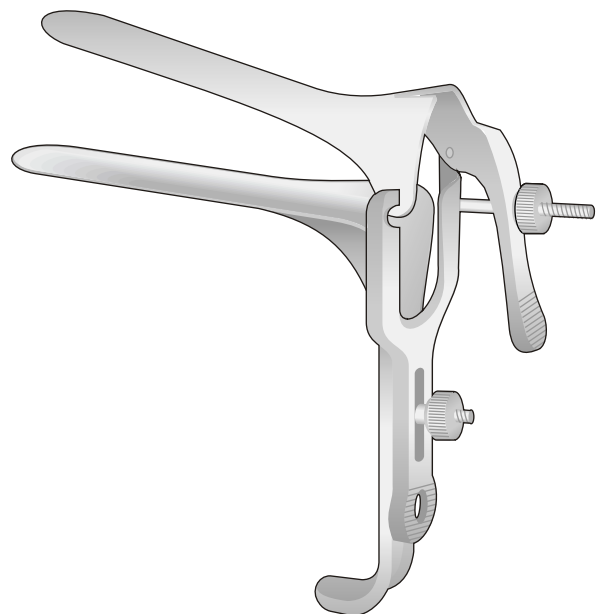

PEDERSON
15-415-01 700x22 mm
15-415-02 720x25 mm

Speculum
Spekula
Specula
Spéculums
Espéculos



KRISTELLER

- Fig. 1 15-420-01 - 70 x 27 mm
- Fig. 2 15-420-02 - 75 x 30 mm
- Fig. 3 15-420-03 - 90 x 36 mm

Valva
Halter
Retractors
Valves
Valvas



KRISTELLER

- Fig. 1 15-420-04 - 75 x 23 mm
- Fig. 2 15-420-05 - 80 x 26 mm
- Fig. 3 15-420-06 - 95 x 32 mm

Speculum + Valva
Specula + Retractor
Spekula + Halter
Spéculum + Valve
Espéculo + Valva

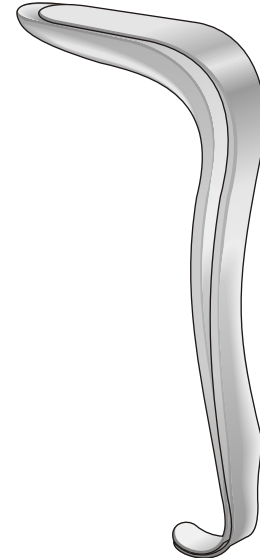

- Fig. 1 15-430-01
- Fig. 2 15-430-02
- Fig. 3 15-430-03

Speculum
Spekula
Specula
Spéculums
Espéculos



KRISTELLER

- Fig. 00 15-440-01 - 110 x 18 mm
- Fig. 0 15-440-02 - 110 x 21 mm
- Fig. 1 15-440-03 - 110 x 27 mm
- Fig. 2 15-440-04 - 110 x 30 mm
- Fig. 3 15-440-05 - 110 x 36 mm

Valva
Halter
Retractors
Valves
Valvas



KRISTELLER

- Fig. 00 15-440-06 - 115 x 14 mm
- Fig. 0 15-440-07 - 115 x 17 mm
- Fig. 1 15-440-08 - 115 x 23 mm
- Fig. 2 15-440-09 - 115 x 26 mm
- Fig. 3 15-440-10 - 115 x 32 mm

Speculum + Valva
Specula + Retractor
Spekula + Halter
Spéculum + Valve
Espéculo + Valva

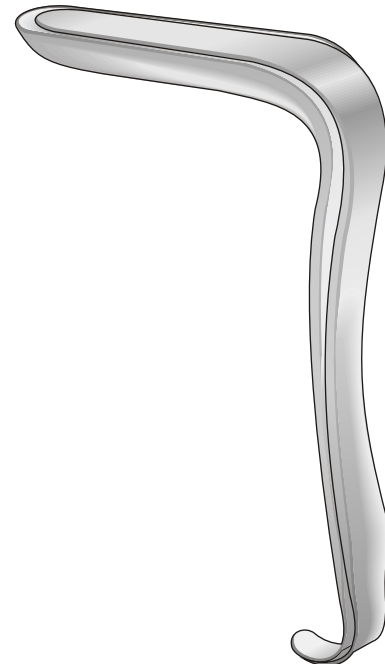

- Fig. 00 15-450-01
- Fig. 0 15-450-02
- Fig. 1 15-450-03
- Fig. 2 15-450-04
- Fig. 3 15-450-05

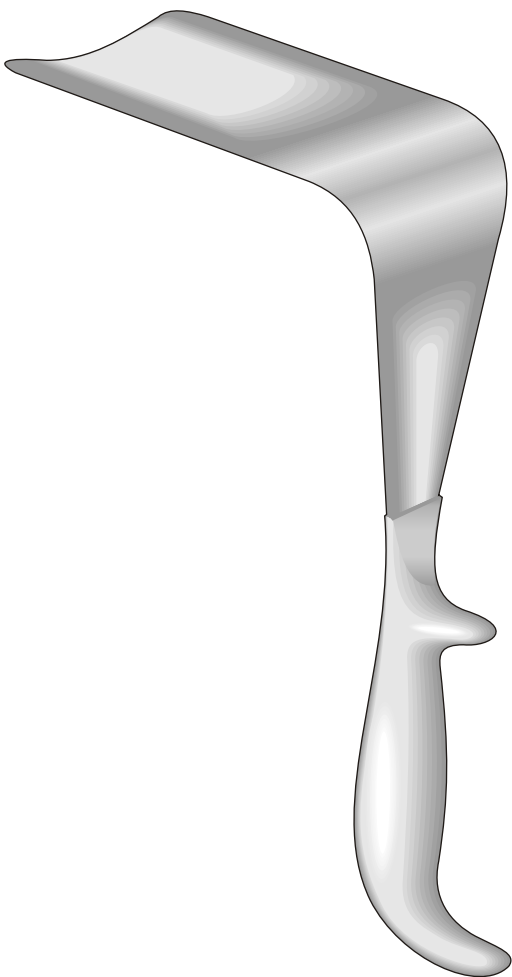

DOYEN
15-460
240 mm

Fig. 1 15-460-01 - 60 x 35 mm
Fig. 2 15-460-02 - 90 x 35 mm
Fig. 3 15-460-03 - 120 x 35 mm

Fig. 1 15-460-04 - 60 x 45 mm
Fig. 2 15-460-05 - 90 x 45 mm
Fig. 3 15-460-06 - 120 x 45 mm
Fig. 4 15-460-07 - 160 x 45 mm

Fig. 1 15-460-08 - 60 x 60 mm
Fig. 2 15-460-09 - 90 x 60 mm
Fig. 3 15-460-10 - 120 x 60 mm
Fig. 4 15-460-11 - 160 x 60 mm

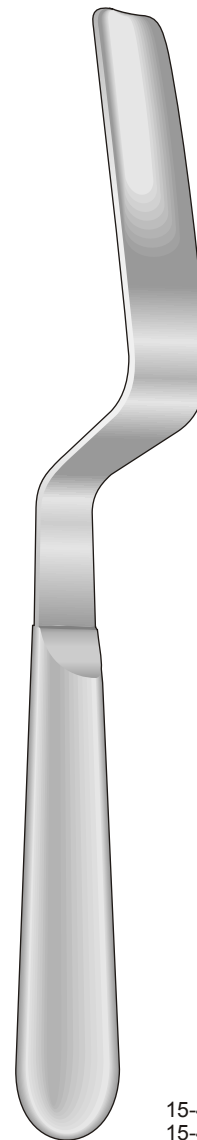

LANDAU
15-470
290 mm

15-470-01 - 100 x 28 mm
15-470-02 - 100 x 38 mm



BREISKY

- 15-480-01 - 100 x 20 mm
 - 15-480-02 - 100 x 25 mm
 - 15-480-03 - 100 x 30 mm
 - 15-480-04 - 100 x 35 mm
 - 15-480-05 - 100 x 40 mm
- 290 mm

BREISKY

- 15-490-01 - 130 x 20 mm
 - 15-490-02 - 130 x 25 mm
 - 15-490-03 - 130 x 30 mm
 - 15-490-04 - 130 x 35 mm
 - 15-490-05 - 130 x 40 mm
- 320 mm

BREISKY

- 15-500-35 - 160 x 40 mm
- 350 mm

BREISKY

- 15-500-37 - 180 x 40 mm
- 370 mm

Hegar Dilatatori - Hegar Dilatators - Hegar Dilatatoren - Hegar Dilateur - Hegar Dilatadores

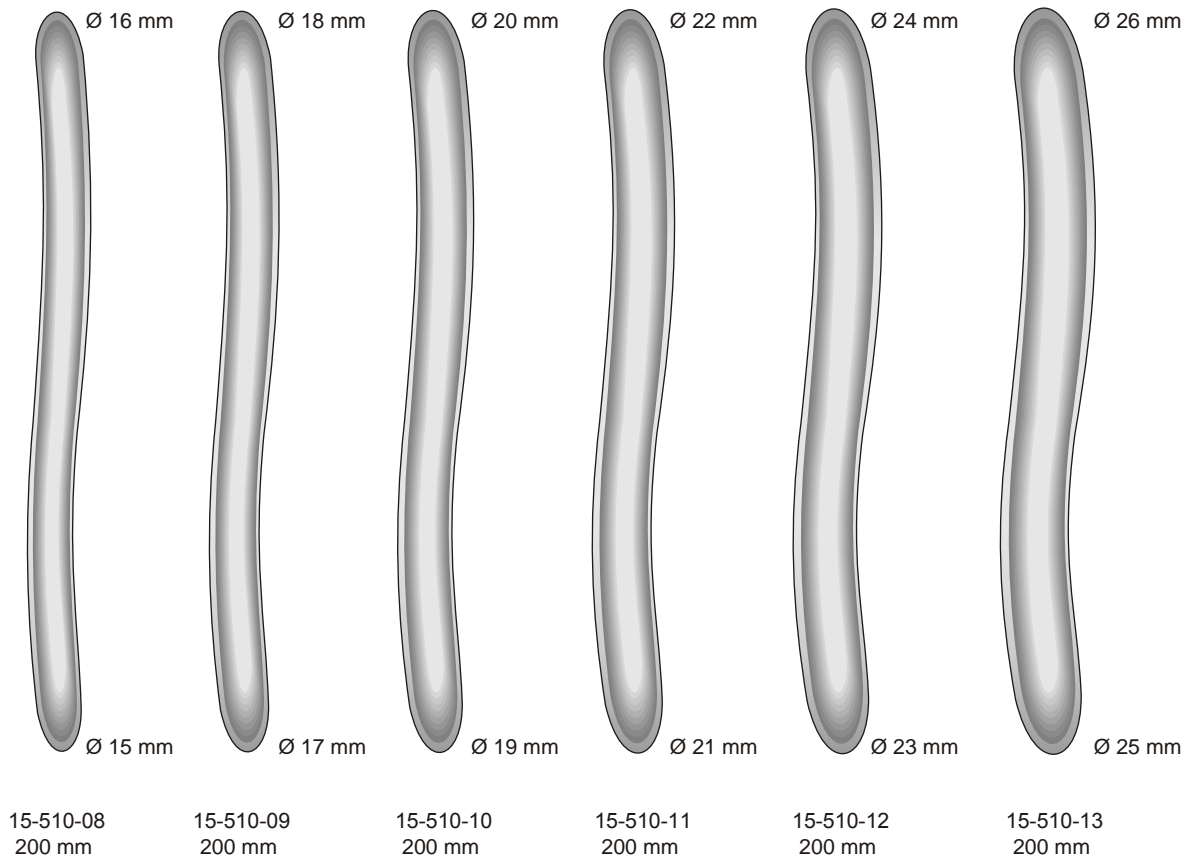
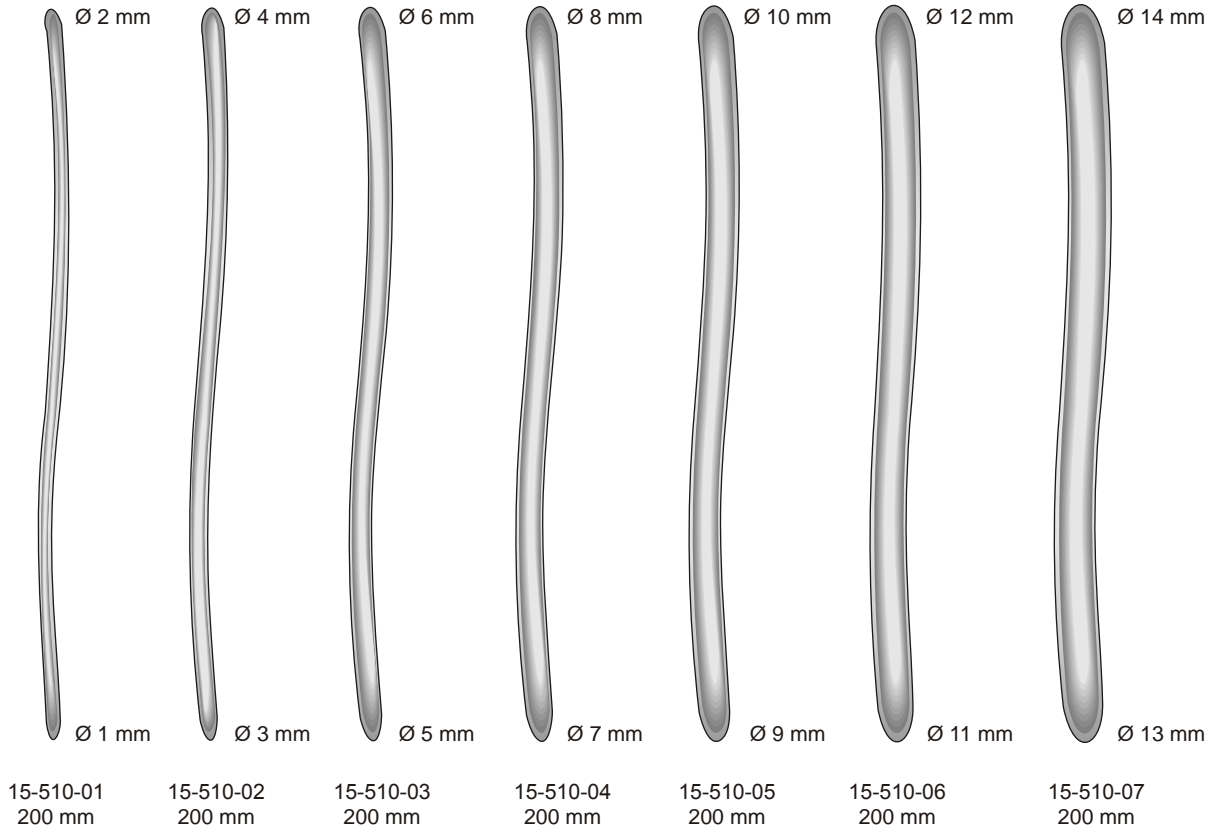

15-520
Set completo dilatatori 8 pezzi
Set complete with 8 pieces
Satz-Dilatator, komplett, 8 Stück
Jeu complet avec 8 pieces
Juego completo con 8 piezas

Pratt Dilatatori
Pratt Dilatators
Pratt Dilatatoren
Pratt Dilatateur
Pratt Dilatadores

La misura è in French
Breite in French

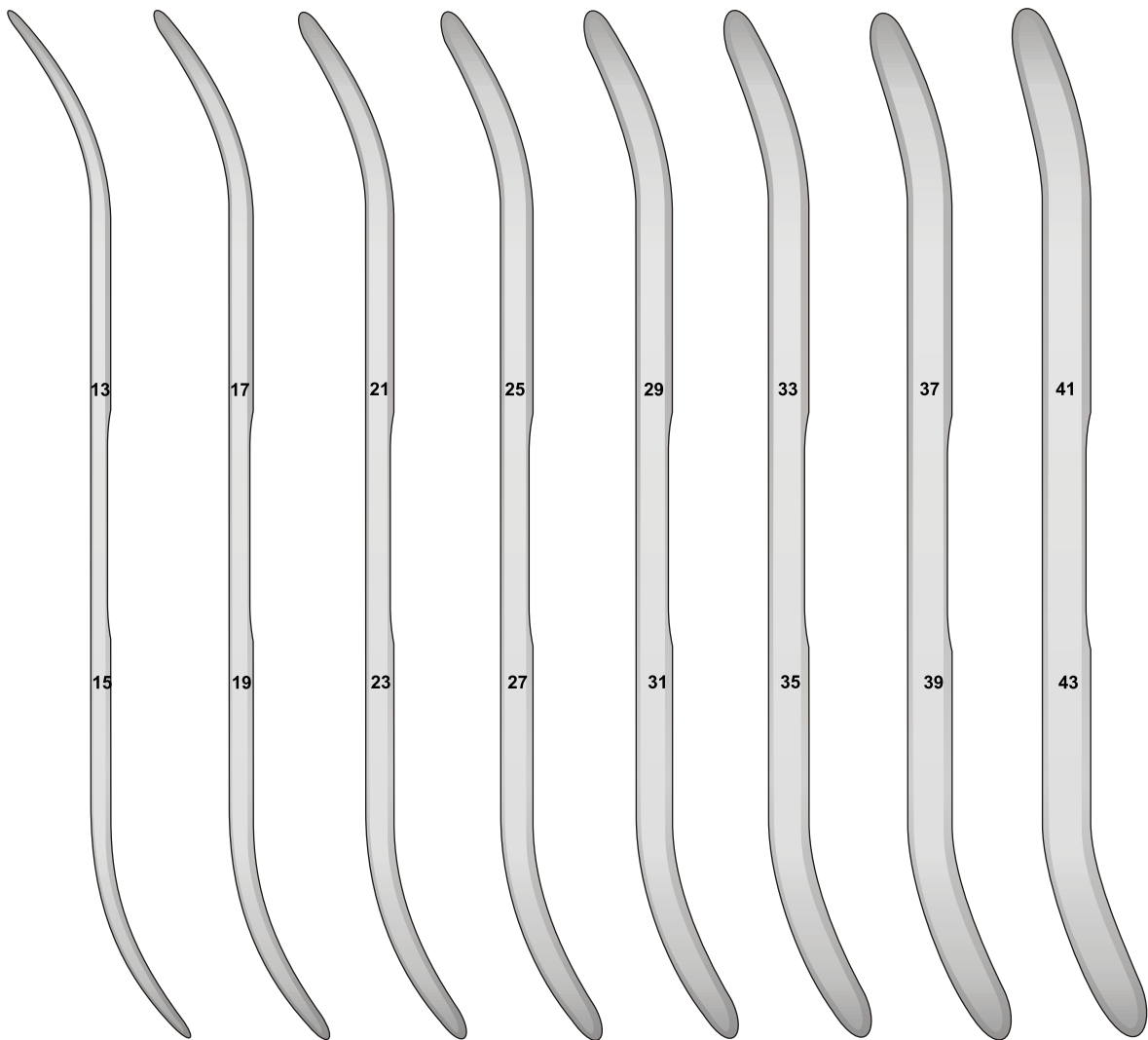

15-520-01 260 mm 15-520-02 260 mm 15-520-03 260 mm 15-520-04 260 mm 15-520-05 260 mm 15-520-06 260 mm 15-520-07 260 mm 15-520-08 260 mm



15-530-01	1 mm	15-530-14	14 mm	15-530-29	1½ mm	15-530-40	14½ mm
15-530-02	2 mm	15-530-15	15 mm	15-530-30	2½ mm	15-530-41	15½ mm
15-530-03	3 mm	15-530-16	16 mm	15-530-31	3½ mm	15-530-42	16½ mm
15-530-04	4 mm	15-530-17	17 mm	15-530-32	4½ mm	15-530-43	17½ mm
15-530-05	5 mm	15-530-18	18 mm	15-530-33	5½ mm		
15-530-06	6 mm	15-530-19	19 mm	15-530-34	6½ mm		
15-530-07	7 mm	15-530-20	20 mm	15-530-35	7½ mm		
15-530-08	8 mm	15-530-21	21 mm	15-530-36	8½ mm		
15-530-09	9 mm	15-530-22	22 mm	15-530-37	9½ mm		
15-530-10	10 mm	15-530-23	23 mm	15-530-38	10½ mm		
15-530-11	11 mm	15-530-24	24 mm	15-530-39	11½ mm		
15-530-12	12 mm	15-530-25	25 mm		12½ mm		
15-530-13	13 mm	15-530-26	26 mm		13½ mm		

HEGAR
15-530
185 mm

Fig. 9/10
Ø 4,5/5,0 mm

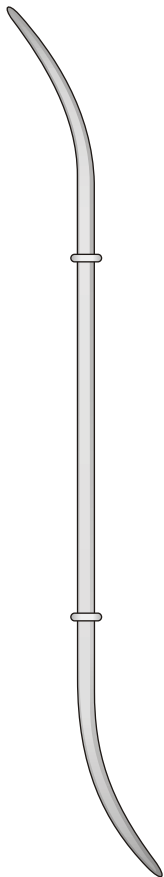

HANK

15-540-01
260 mm

Fig. 11/12
Ø 5,5/6,0 mm

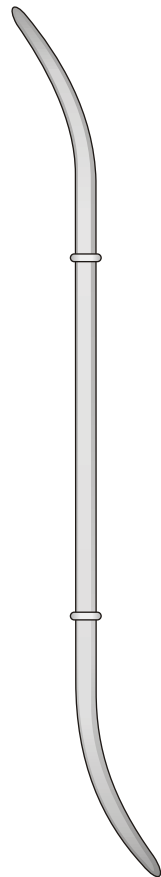

HANK

15-540-02
260 mm

Fig. 13/14
Ø 6,5/7,0 mm

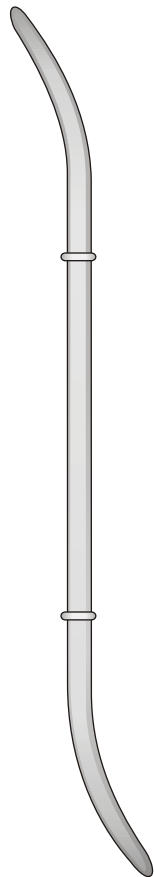

HANK

15-540-03
260 mm

Fig. 15/16
Ø 7,5/8,0 mm

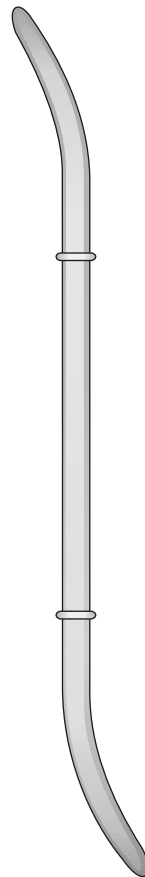

HANK

15-540-04
260 mm

Fig. 17/18
Ø 8,5/9,0 mm

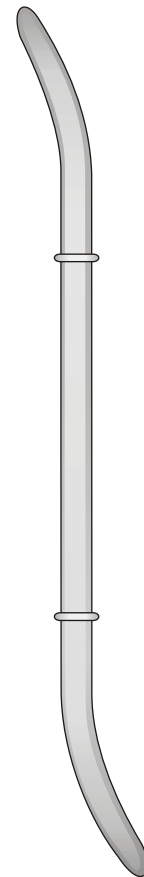

HANK

15-540-05
260 mm

Fig. 19/20
Ø 9,5/10 mm

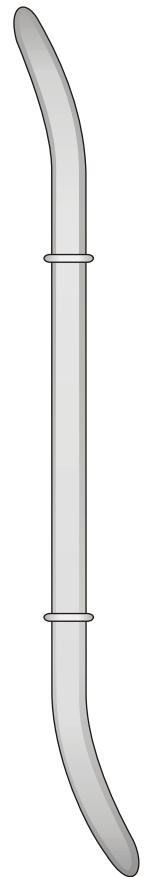

HANK

15-540-06
260 mm

Graduati in centimetri
Graduated in centimeters
Zentimetereinteilung
Gradué en centimètres
Graduado en centímetros

Malleabile
Malleable
Biigsam
Malléables
Maleables

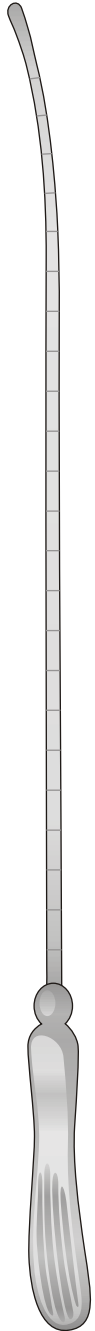

SIMS
15-550
320 mm

Malleabile
Malleable
Biigsam
Malléables
Maleables

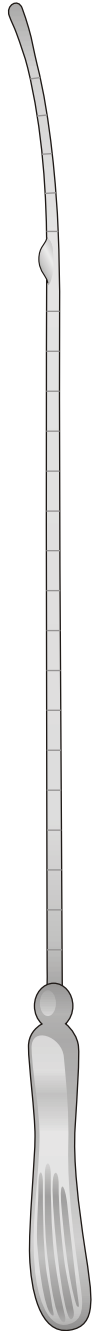

SIMPSON
15-560-01 Ø 3mm
320 mm

Rigido
Rigid
Fest
Rigides
Rigidos

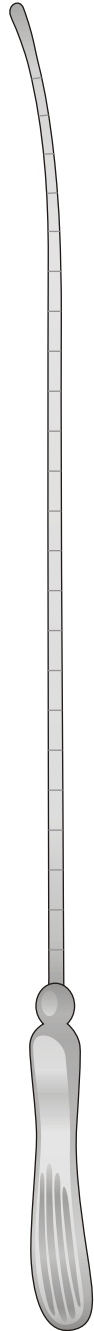

SIMS
15-570
320 mm

15-570-01
Ø 3 mm

15-570-02
Ø 4 mm



VALLEIX
15-580 Ø 4mm
265 mm

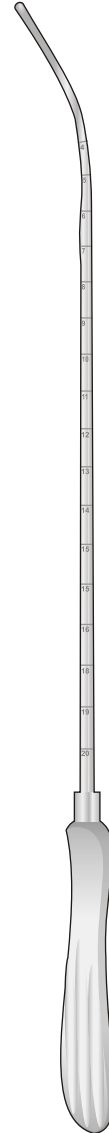

MARTIN
15-590 Ø 3mm
300 mm

Malleabile
Malleable
Biigsam
Malléables
Maleables

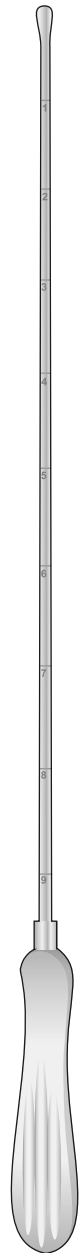

MAYO
15-600 Ø 5mm
330 mm

Amniotomo per la
vescica amniotica
Amniotome for the
amnion bladder
Amniotom für die
Amnionblase
Amniotome pour la
vésicule amniotique
Amniótomo para la
vesicula amniótica

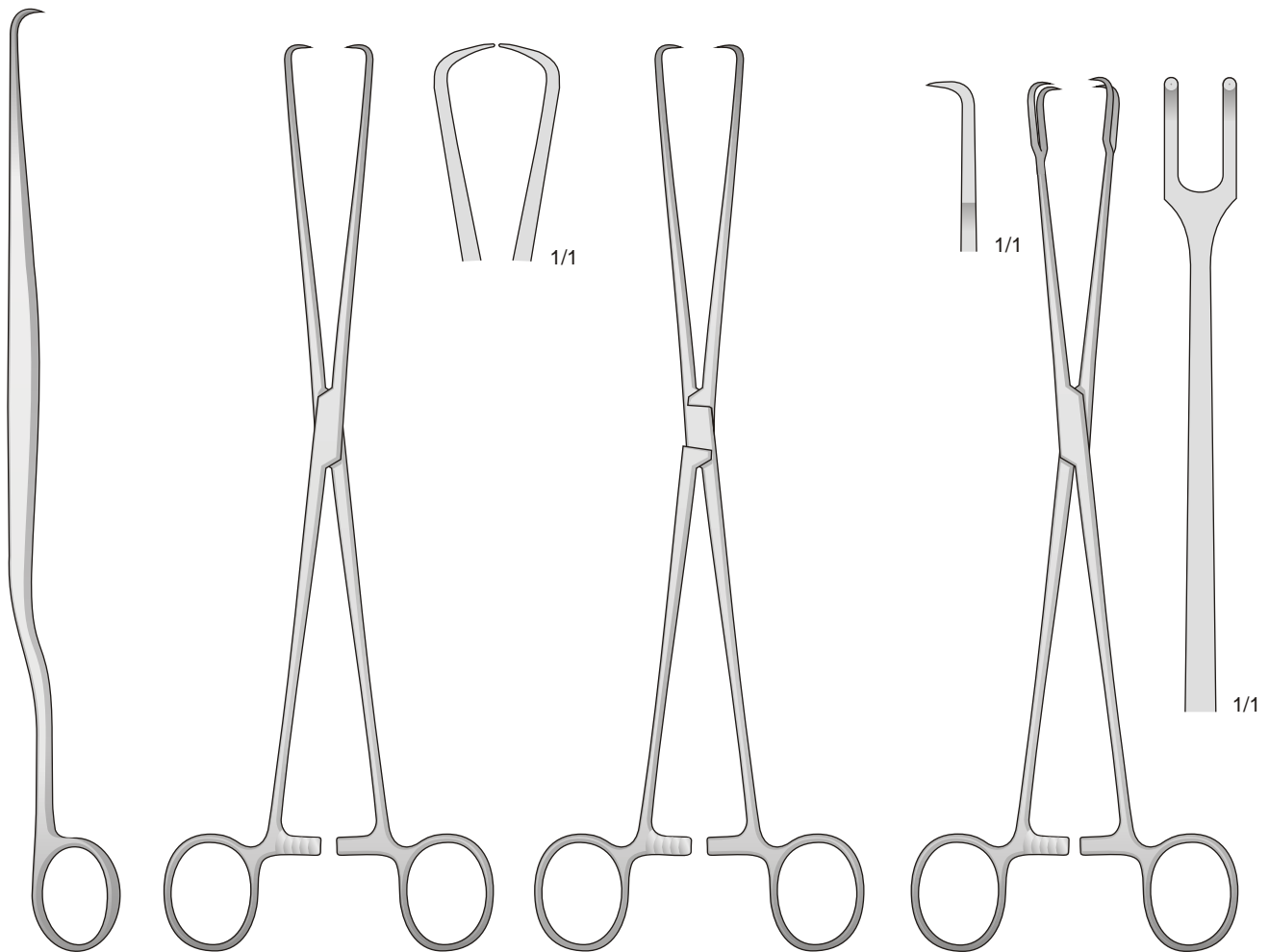

BEACHAM
15-610-26
260 mm

BRAUN
15-620-25
250 mm

POZZI
15-630-25
250 mm

SCHROEDER
15-640-24
240 mm

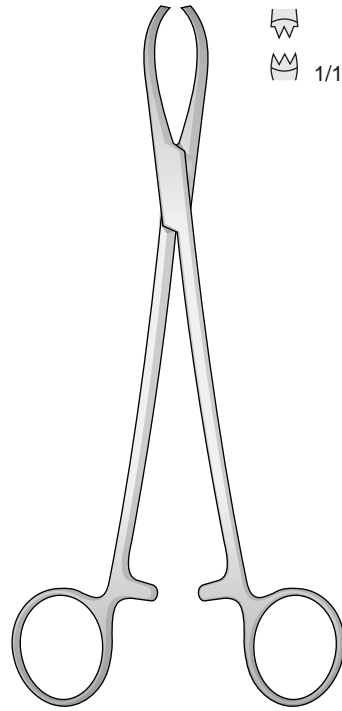

LITTLEWOOD

15-650-18
185 mm

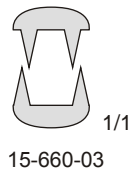
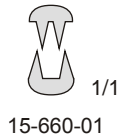
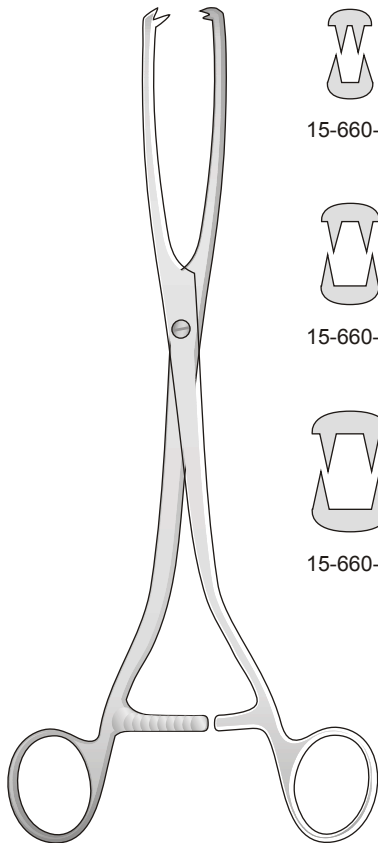

MUSEUX
15-660
240 mm

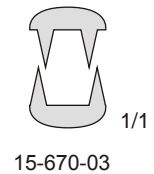
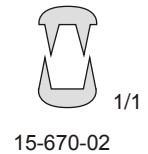
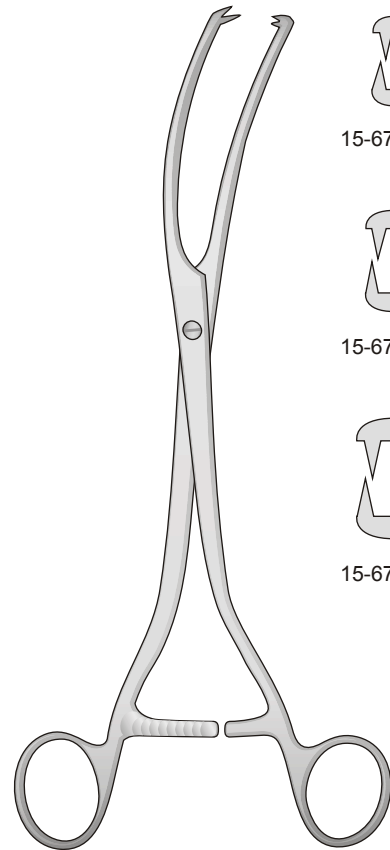

MUSEUX
15-670
240 mm

Pinzette per tube

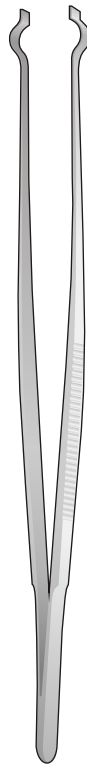

NEUBÜSER
15-680
200 mm

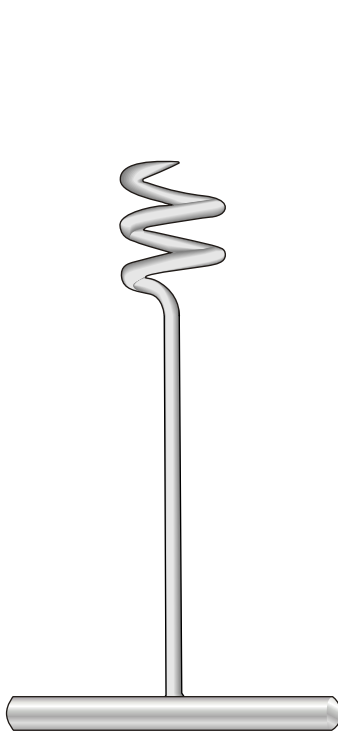
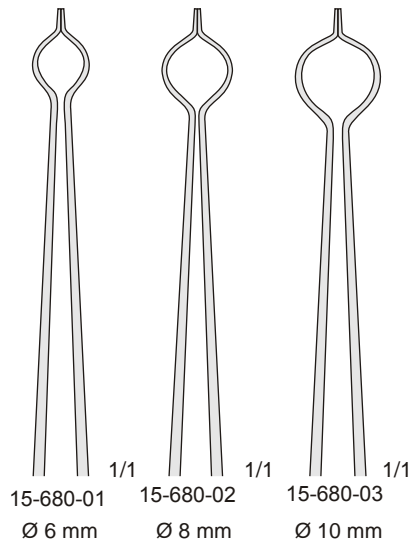

DOYEN
15-690-15
150 mm

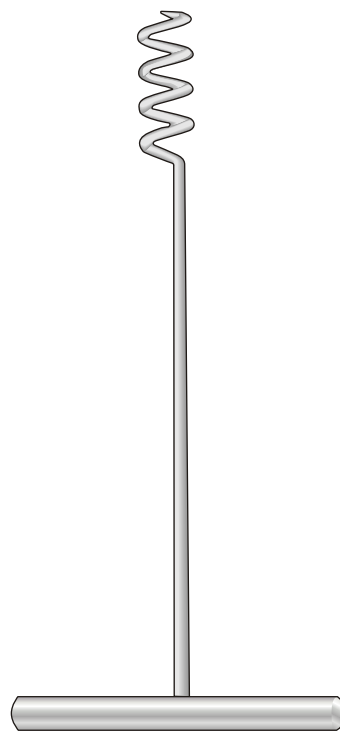

DOYEN
15-690-17
170 mm

Curette per biopsia endouterina
Endometrial Biopsy curette
Endometrium-Strichkürette
Curette pour biopsie intra-utérines
Cureta para biopsia endo-uterina

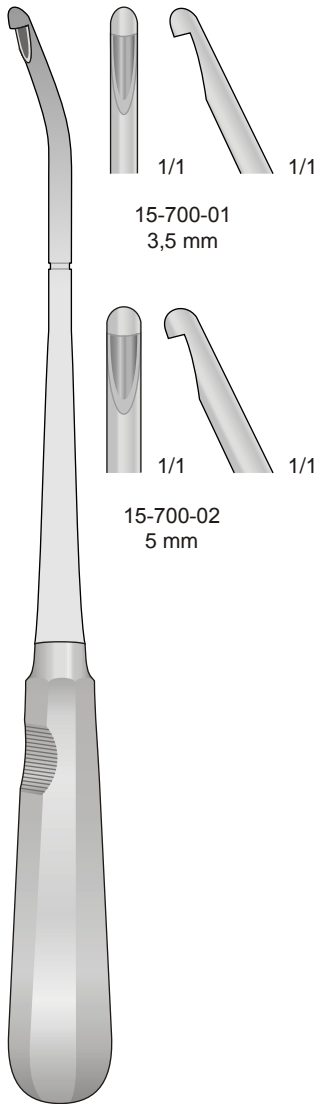

MÜNCHEN
15-700
270 mm

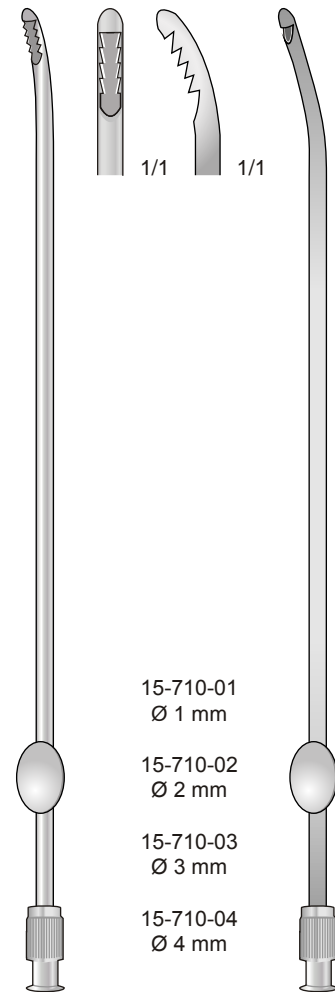

NOVAK
15-710
230 mm

RANDALL
15-720-23
230 mm

Curette per biopsia endocervicale
Endocervical Biopsy Curettes
Endocervix-Biopsieküretten

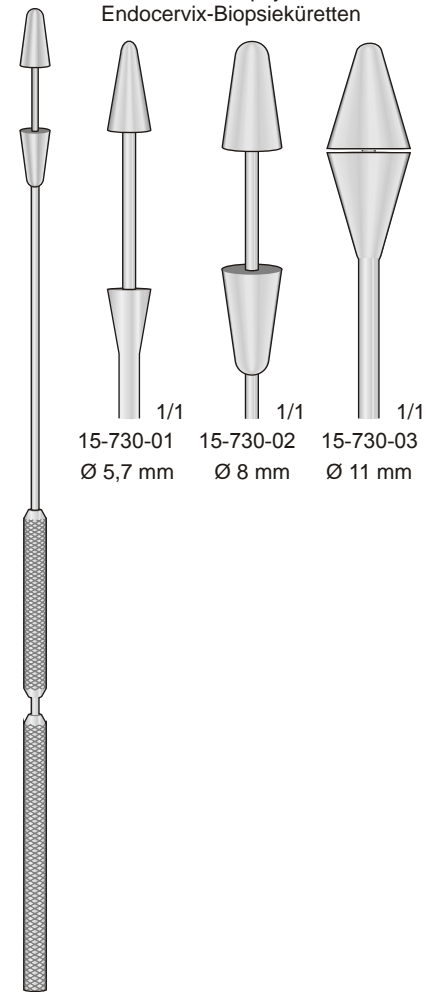

GUSBERG
15-730
240 mm

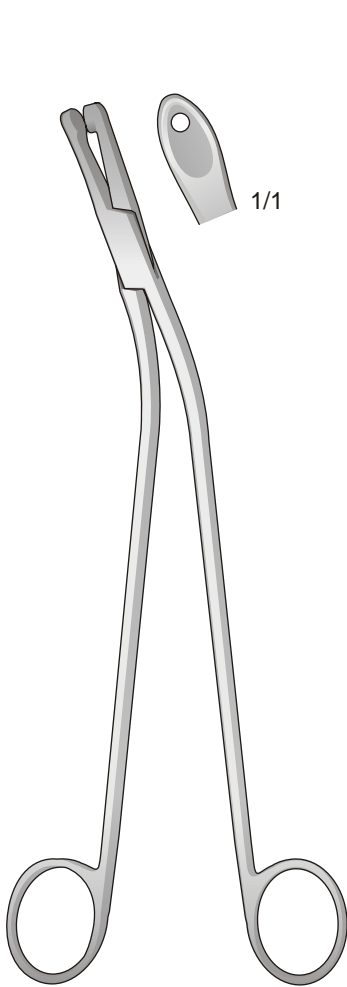

GELLHORN
15-740-23
230 mm

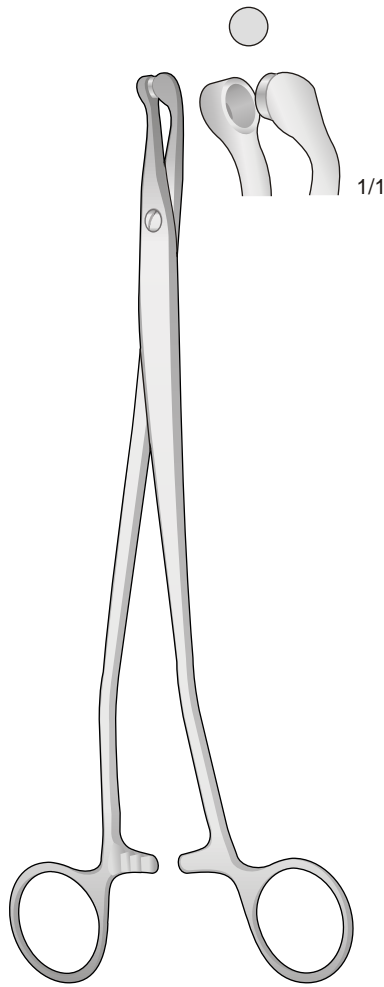

THOMS-GAYLOR
15-750-01
240 mm

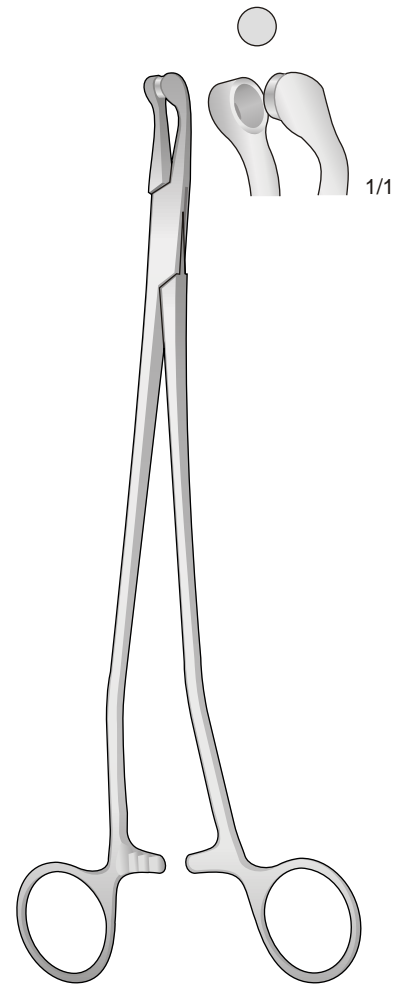

THOMS-GAYLOR
15-750-02 220 mm
15-750-03 240 mm

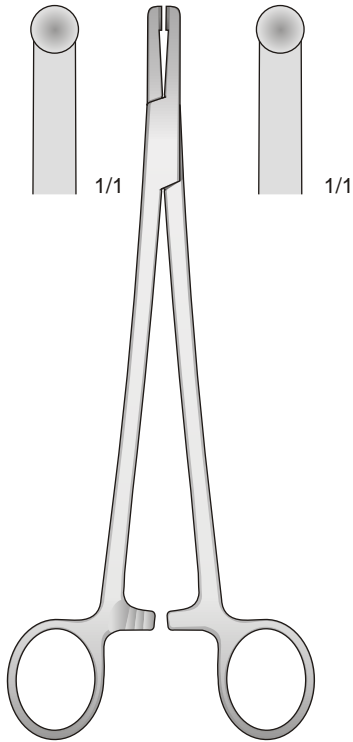

15-760
205 mm

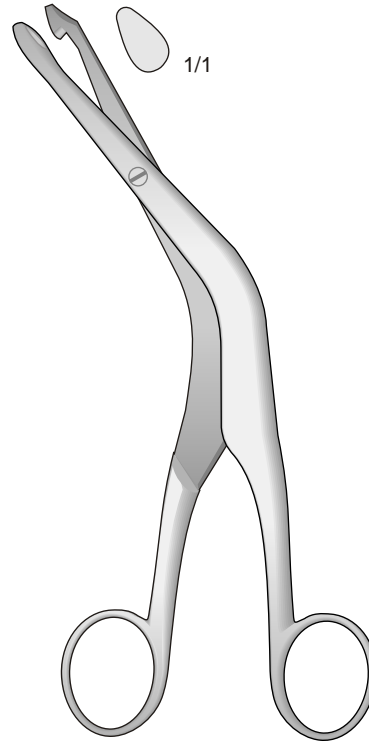

FAURE
15-770
210 mm

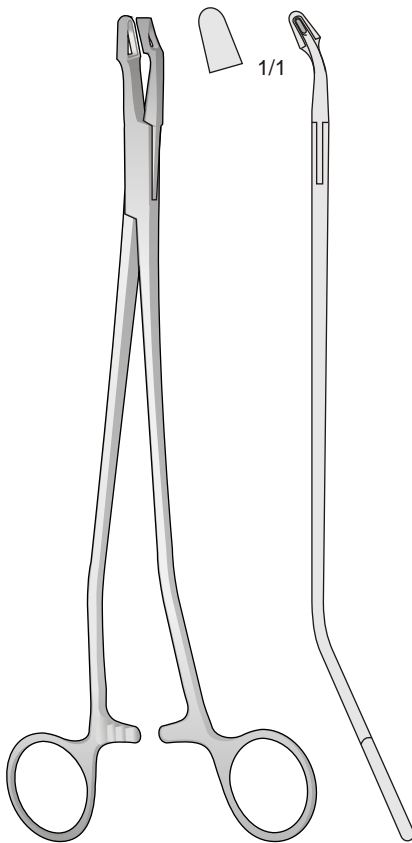

VAN DOREN
15-780-25
250 mm

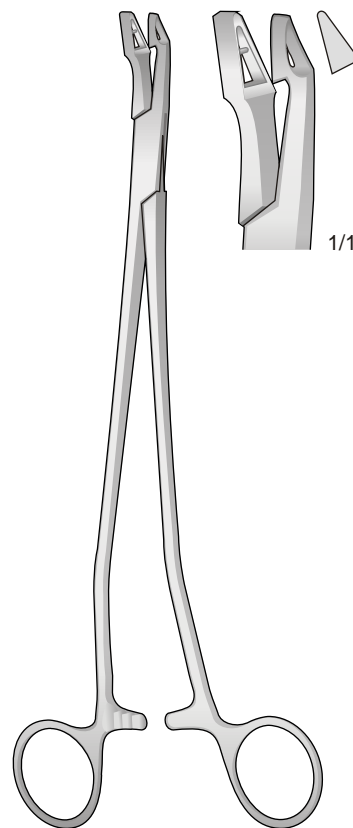

VAN DOREN
15-780-24
240 mm

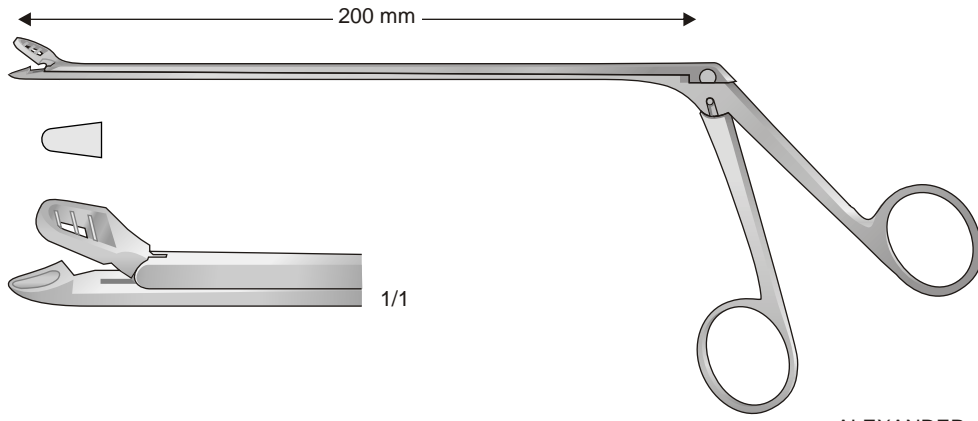

ALEXANDER
15-790

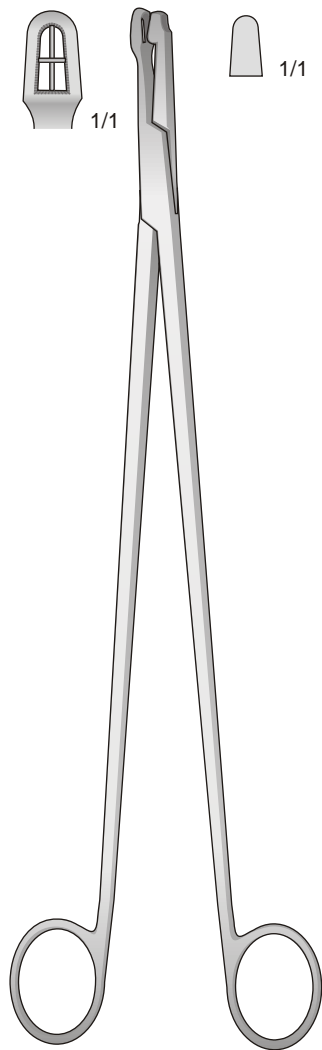

SCHUBERT
15-800-21 210 mm
15-800-29 290 mm

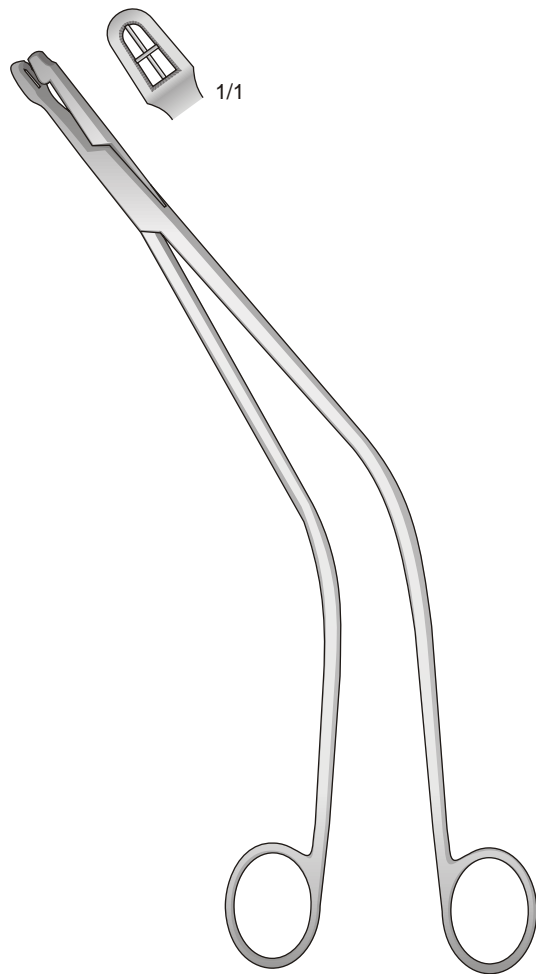

SCHUBERT
15-810
260 mm

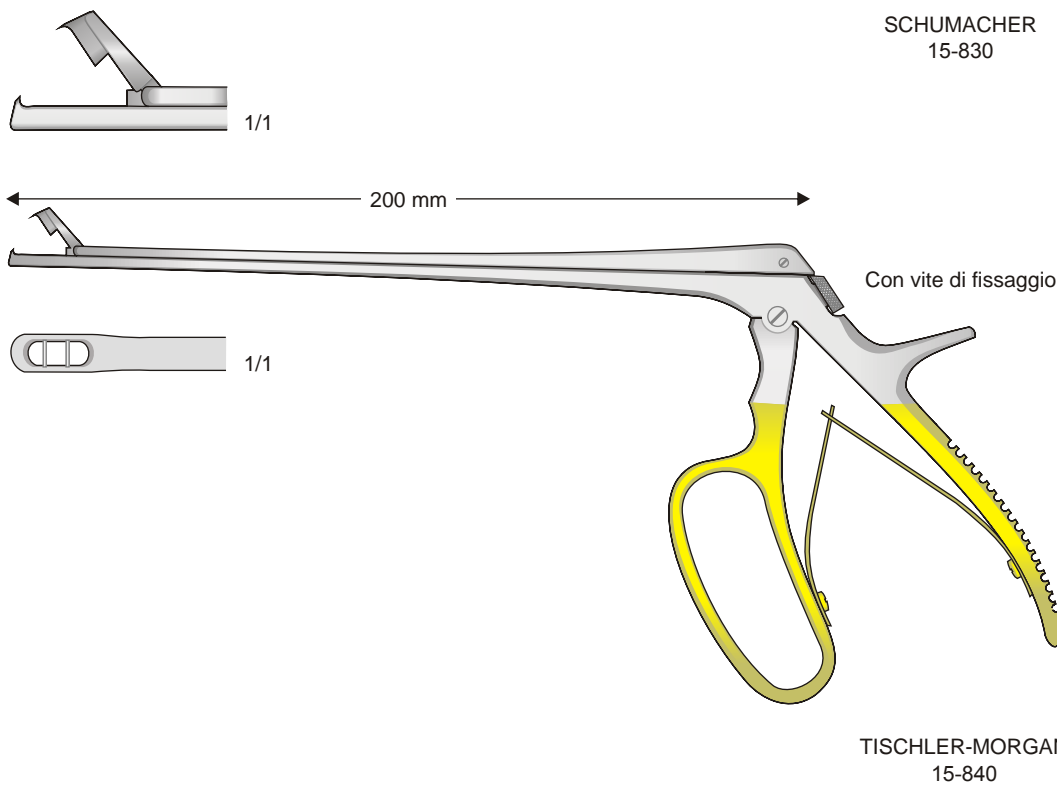
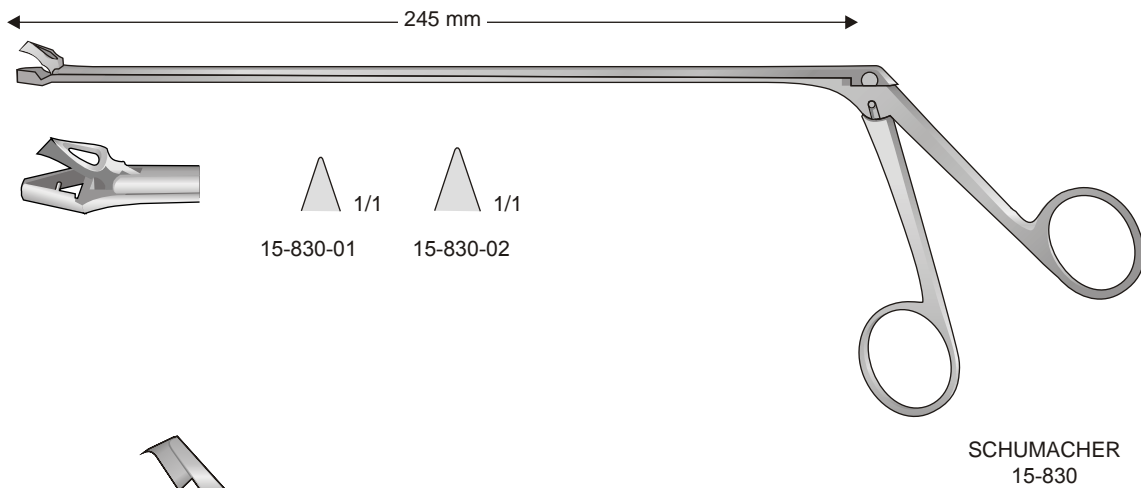
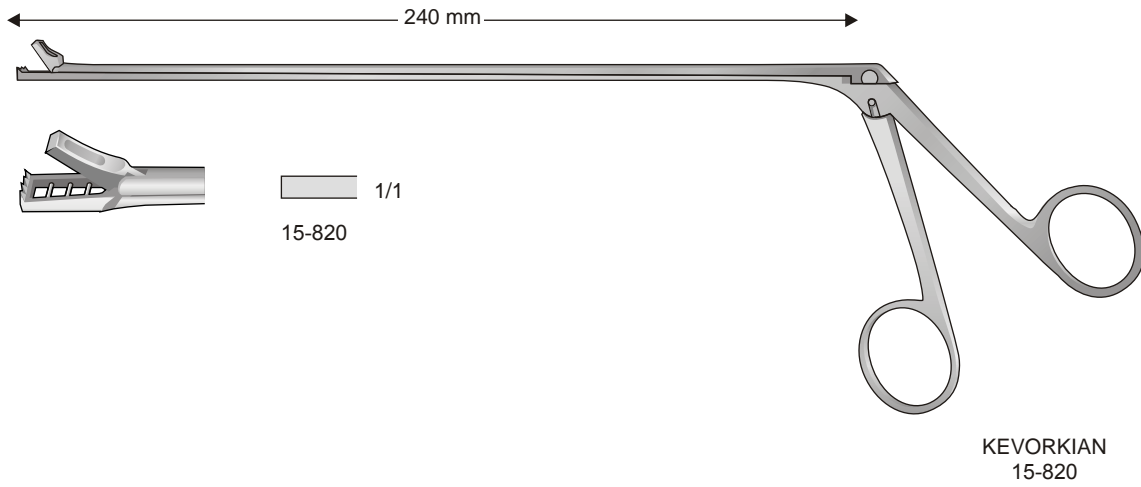

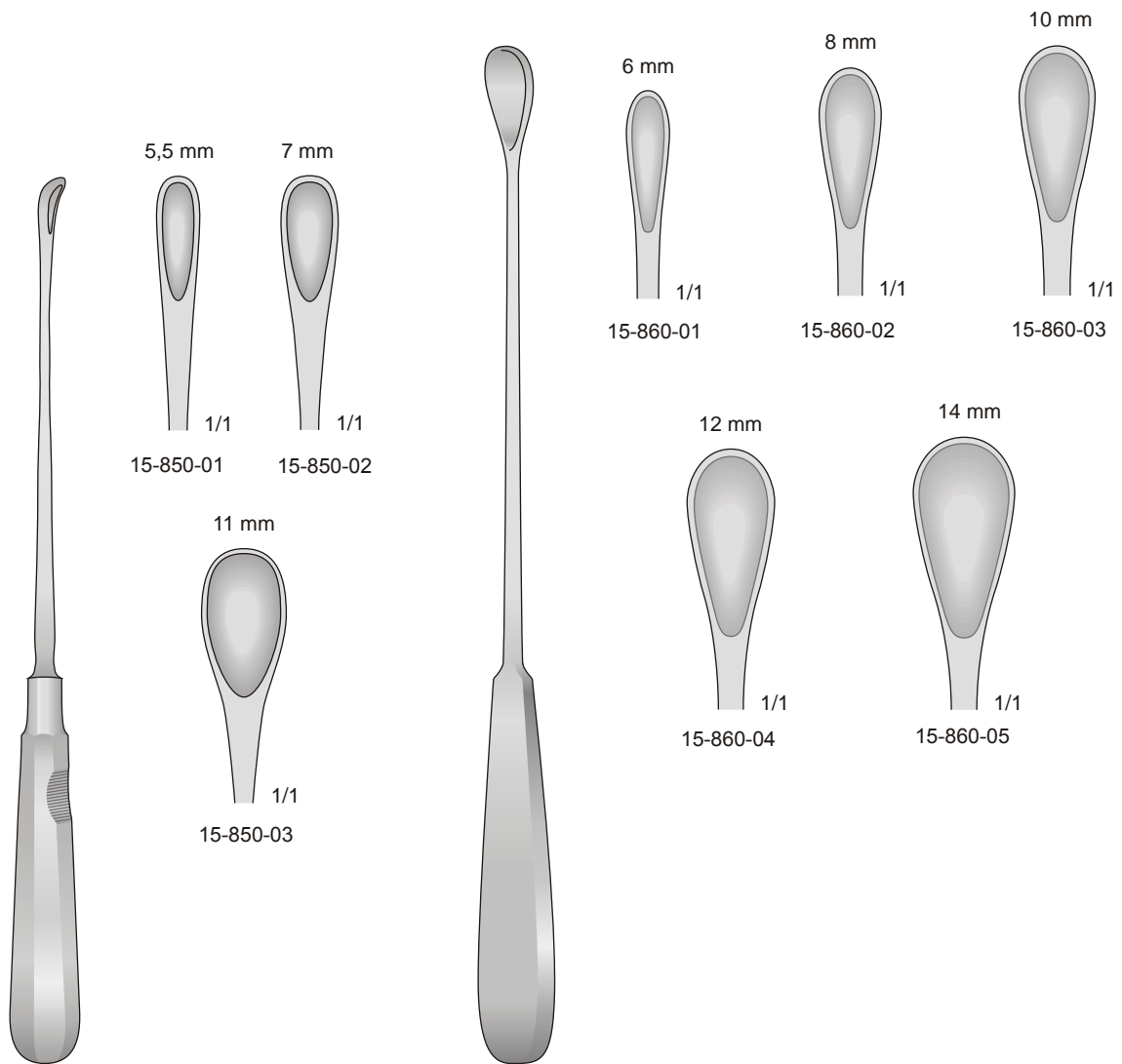

LUER-KÖRTE
15-850
260 mm

GOURDET
15-860
280 mm

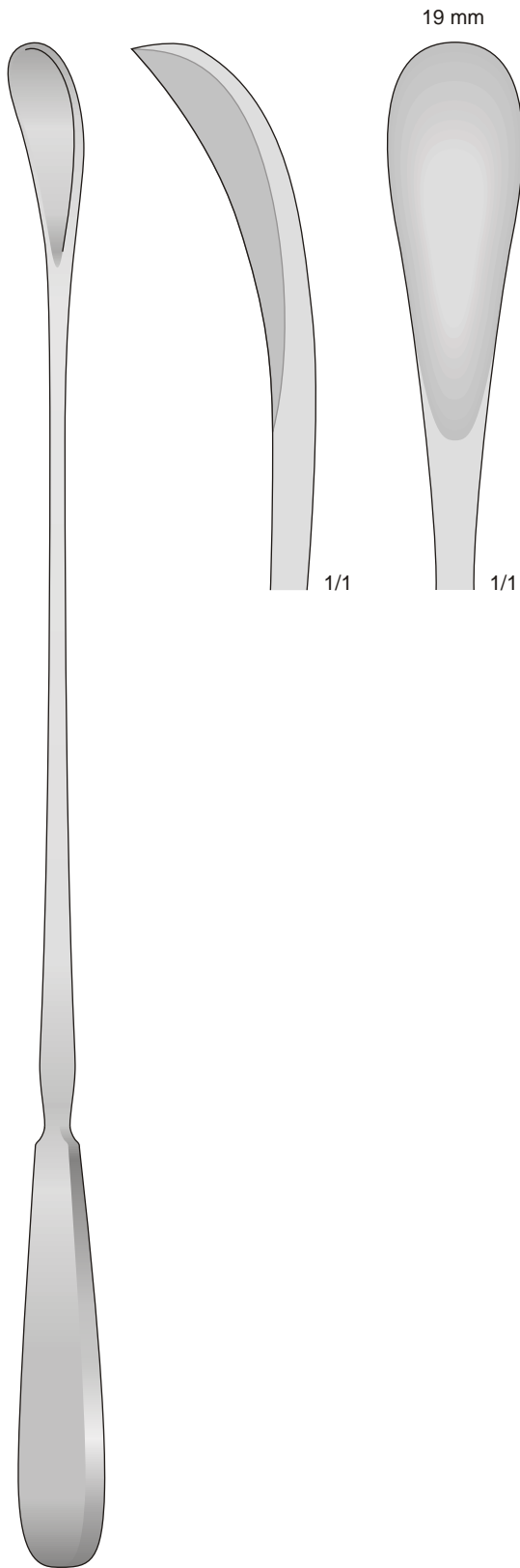

WALLICH
15-870
420 mm

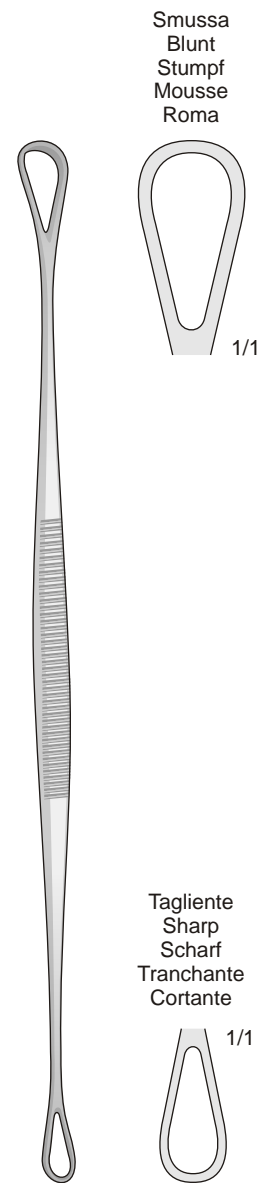

BLAKE
15-880
275 mm

Taglienti
Scharp
Scharf
Tranchantes
Cortantes

Smussa
Blunt
Stumpf
Mousse
Romas

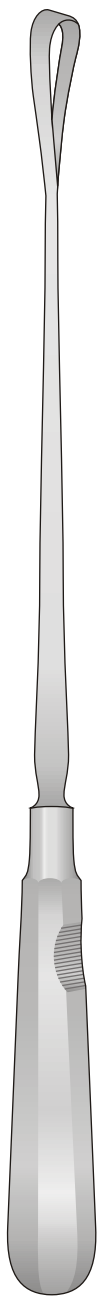

RECAMIER
15-890
310 mm

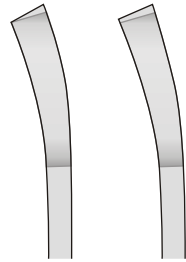
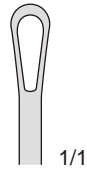
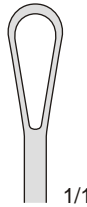

Fig. 1



1/1

Fig. 2



1/1

Fig. 3



1/1

Fig. 4



1/1

Fig. 5

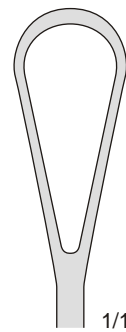

1/1

Fig. 6

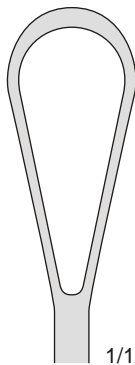

1/1

Fig. 7

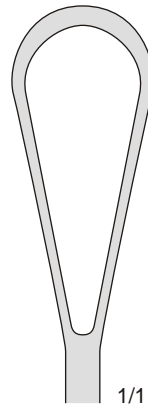

1/1

Fig. 8

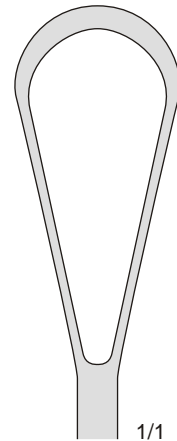

1/1

Fig.	Larghezza Width Breite	Taglienti-rigide Sharp-rigid Scharf-fest Tranchantes-rigides Cortantes-rigidas	Smusse-rigide Blunt-rigid Stumpf-fest Mousse-rigides Romas-rigidas
1	4 mm	15-890-01	15-890-09
2	6 mm	15-890-02	15-890-10
3	8 mm	15-890-03	15-890-11
4	10 mm	15-890-04	15-890-12
5	12 mm	15-890-05	15-890-13
6	14 mm	15-890-06	15-890-14
7	16 mm	15-890-07	15-890-15
8	18 mm	15-890-08	15-890-16

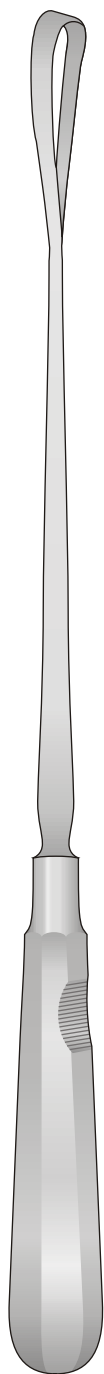

BUMM
15-900
310 mm

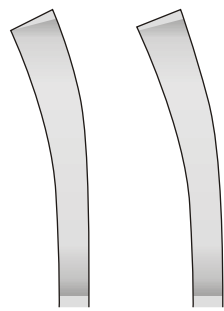

Tagliente
Scharp
Scharf
Tranchantes
Cortantes

Smussa
Blunt
Stumpf
Mousse
Romas

Malleabile
Malleable
Biegsam
Souples
Maleables

Fig. 3

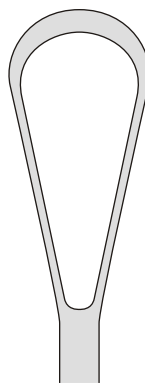
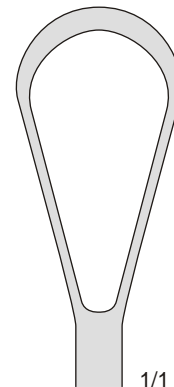

Fig. 4



1/1

Fig.	Larghezza Width Breite	Taglienti Sharp Scharf Tranchantes Cortantes	Smusse Blunt Stumpf Mousse Romas
3	18 mm	15-900-13	15-910-18
4	20 mm	15-900-20	15-910-20

Fig.	Larghezza Breite Width	Smusse malleabili - Blunt malleable Stumpf biegsam - Mousse malléables Romas maleables
0	16 mm	15-920-01
1	18 mm	15-920-02
2	19,5 mm	15-920-03
3	21,5 mm	15-920-04
4	23,5 mm	15-920-05
5	26 mm	15-920-06
6	28,5 mm	15-920-07

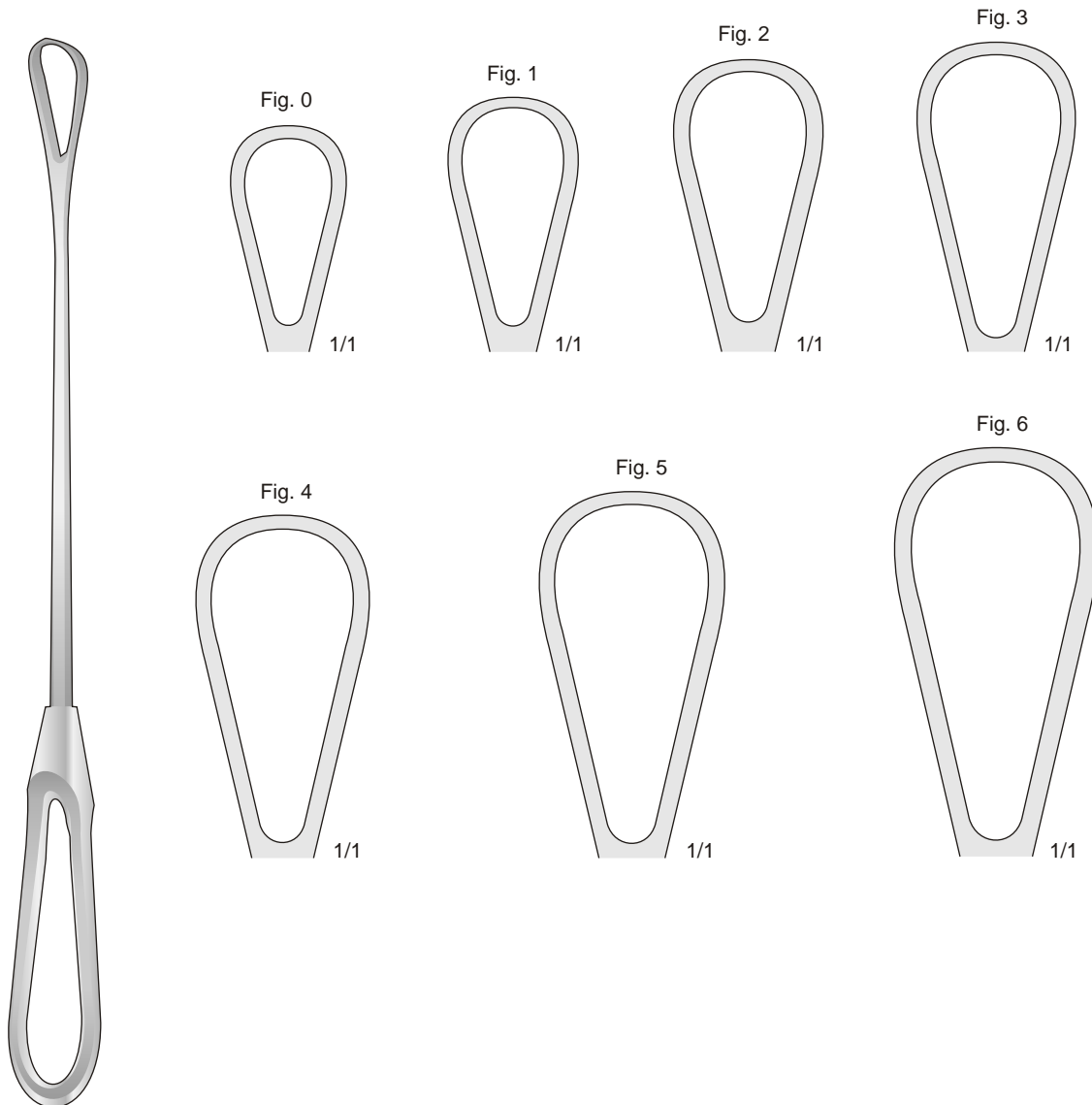

BUMM
15-920
290 mm

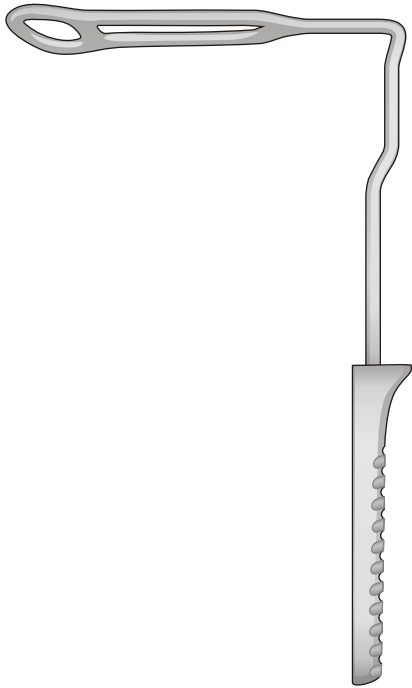

GENTOFT
15-930-01
210 mm

Set 2 pezzi
Set 2 pieces
Set 2 Stück
Set 2 pièçes
Set 2 piezas
15-930

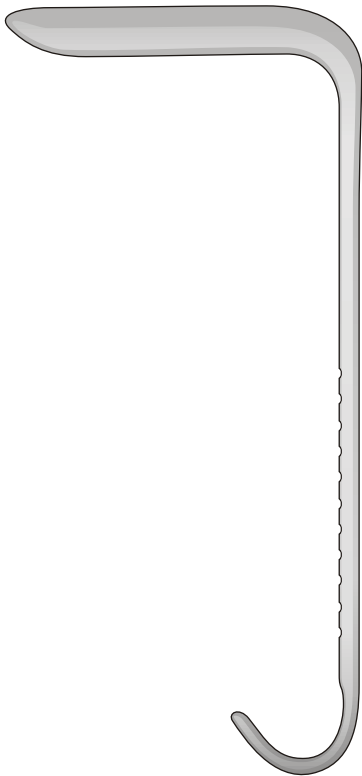

FENO
15-930-02
230 mm

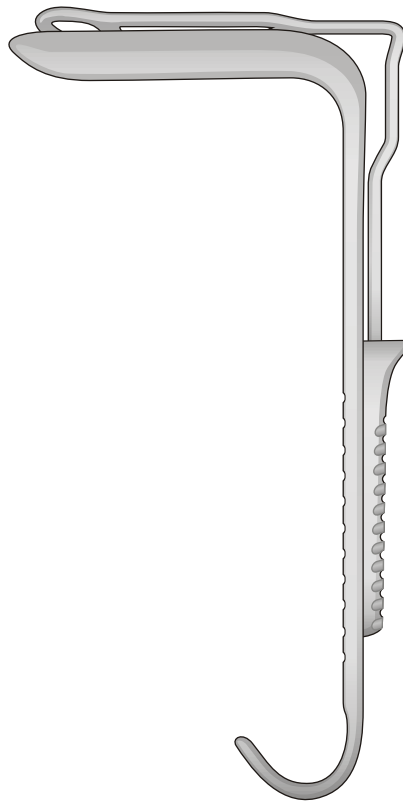

15-940-23
230 mm

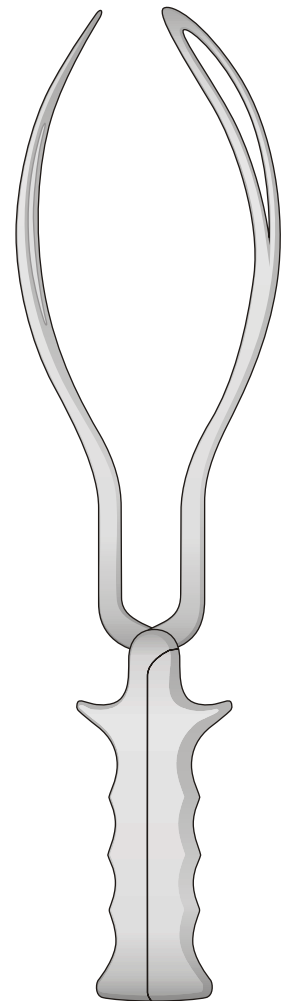

SIMPSON-BRAUN
15-950-36
365 mm