



ADDENDUM

Diagnostik-Bestecke - Diagnostic Sets
Set Diagnostica - Set Diagnóstico
Troussets à Diagnostic

Etui für McIntOSH Fig. 1-3
Case for McIntOSH Fig. 1-3
Cassetta per laringoscopio McIntOSH Fig. 1-3
Estuche para McIntOSH Fig. 1-3
Etui pour McIntOSH Fig. 1-3

Halogen - Alogeno



18-100
Otoscopio completo con custodia



18-110

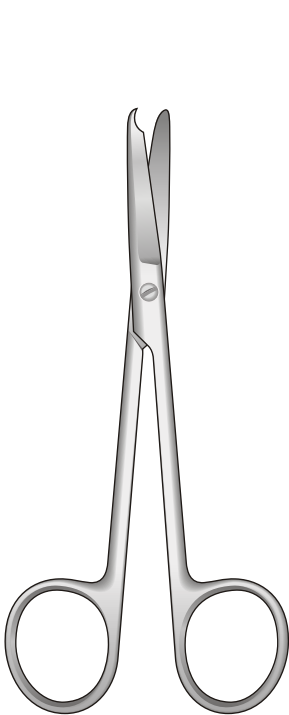

SPENCER
18-120-12
120 mm

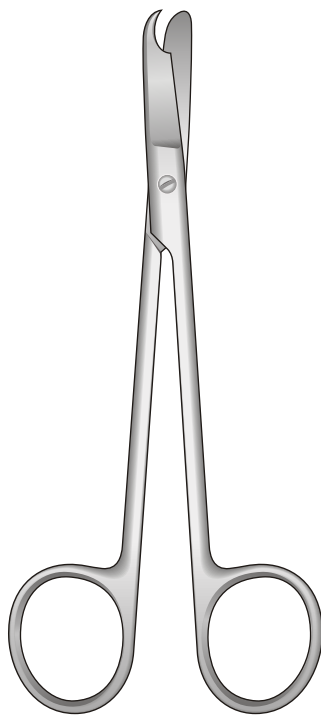

LITTAUER
18-120-14
140 mm

Wellenschliff
TC

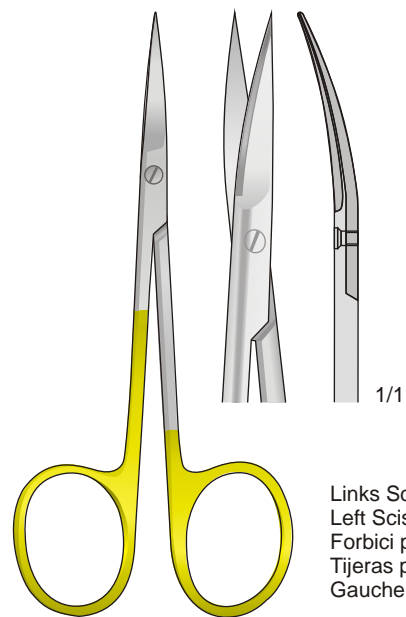

IRIS
18-130-11
110 mm

Links Scheren
Left Scissors
Forbici per mancini
Tijeras para zurdos
Gauche Ciseaux

“Ribbon type”

Mit großen Ringen
With large rings
Forbici ad anelli grandi
Con anillos especialmente grandes
avec larges anneaux

Iris scissors

Blepharoplasty
Blefaroplastica

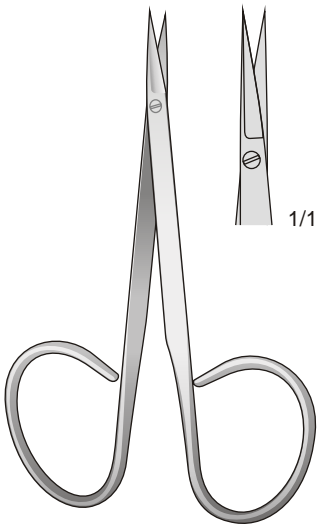

18-140-09
95 mm

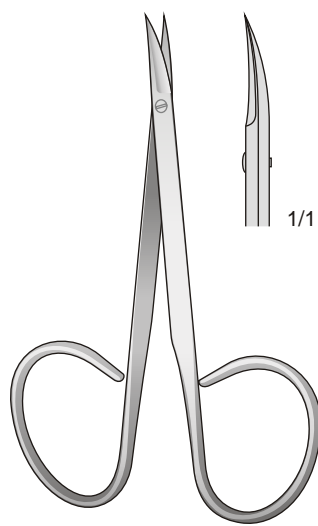

18-150-09
95 mm

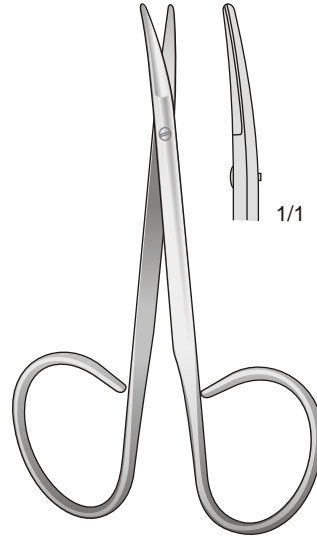

18-160-09
95 mm

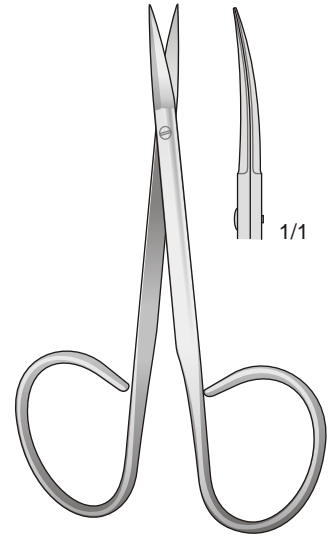

18-170-10
105 mm

Iris scissors

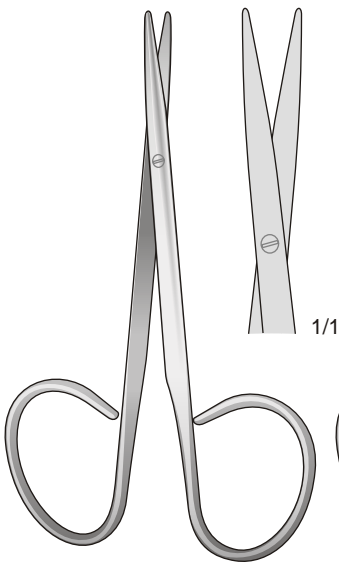

18-180-10
100 mm

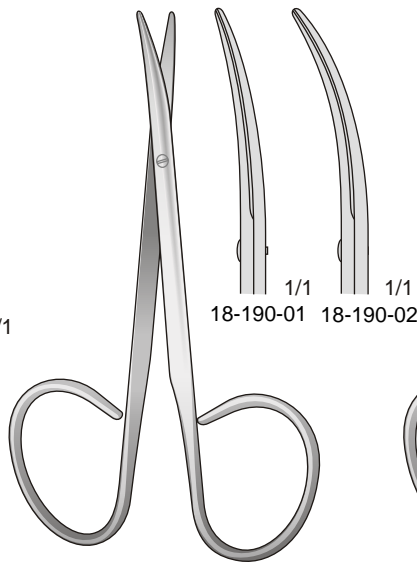

18-190
100 mm

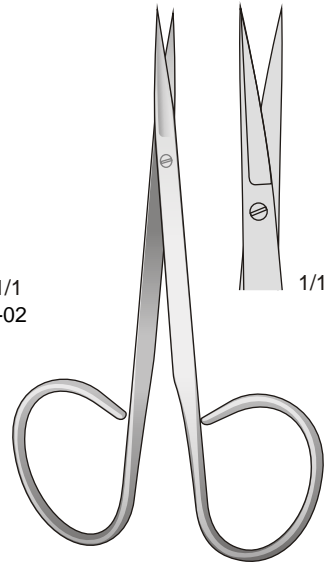

18-200-10
105 mm

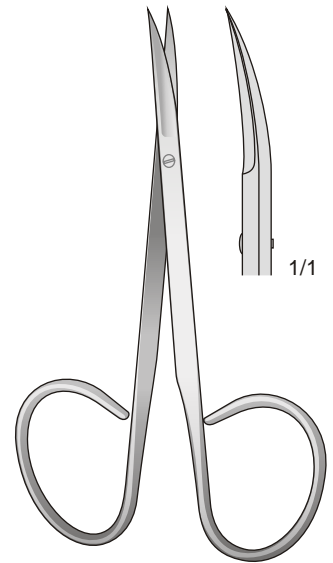

18-210-10
105 mm

"Ribbon type"

Mit großen Ringen
With large rings
Forbici ad anelli grandi
Con anillos especialmente grandes
avec larges anneaux

Spitz
Sharp
Acuta
Aguda
Pointu

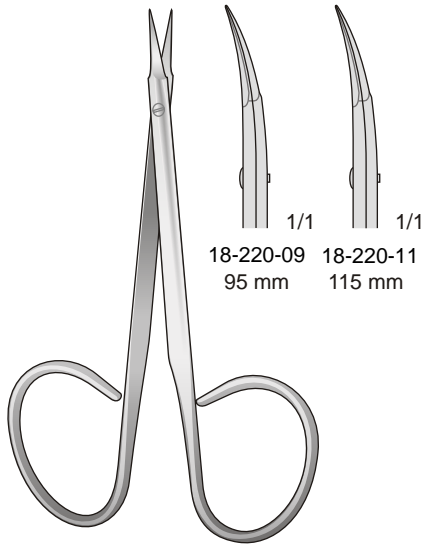

18-220
STITCH

Stumpf
Blunt
Smussa
Romas
Mousse

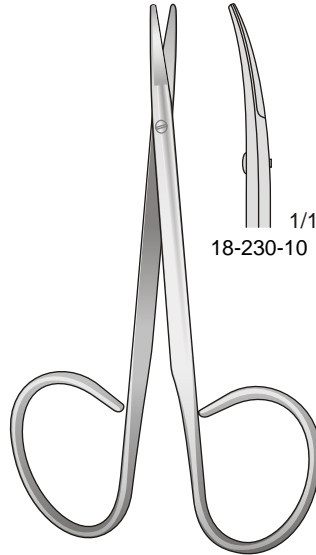

18-230
100 mm

Gezahnt
Serrated
Dentellata
Dentadas
Dentelés

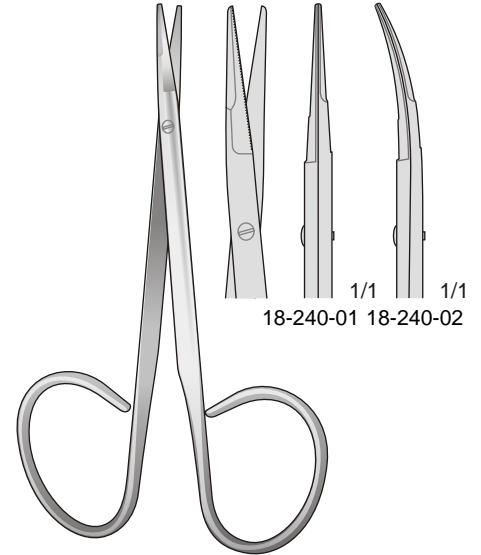

KAYE
18-240
105 mm

Stumpf - Blunt
Smussa - Romas
Mousse

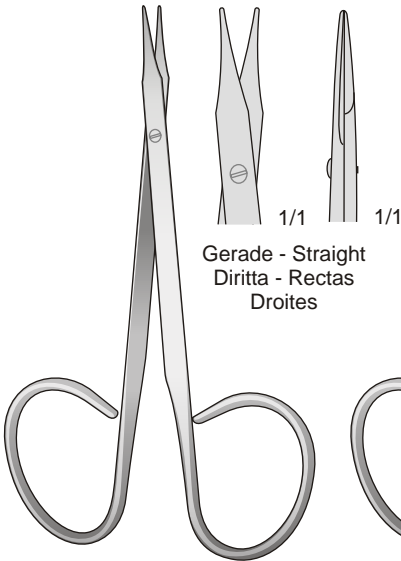

STEVENS
18-250-10
100 mm

Stumpf - Blunt
Smussa - Romas
Mousse

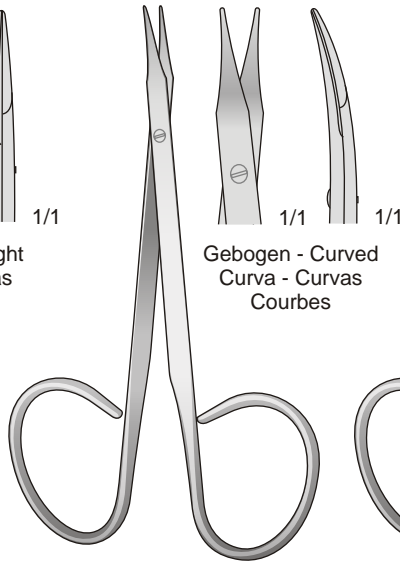

STEVENS
18-260-10
100 mm

Spitz - Sharp
Acuta - Aguda
Pointu

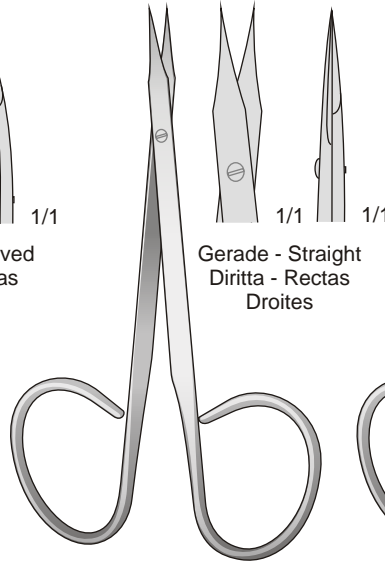

WALTON
18-270-10
100 mm

Spitz - Sharp
Acuta - Aguda
Pointu

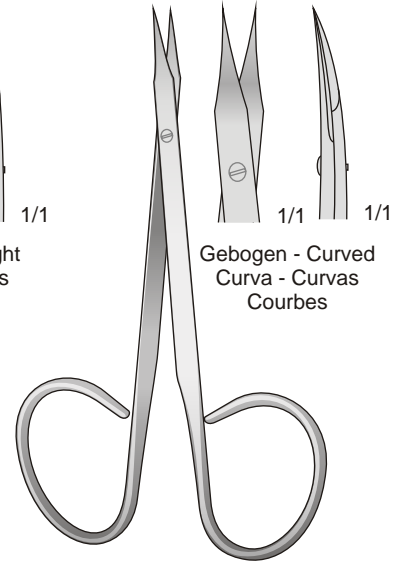

WALTON
18-280-10
100 mm

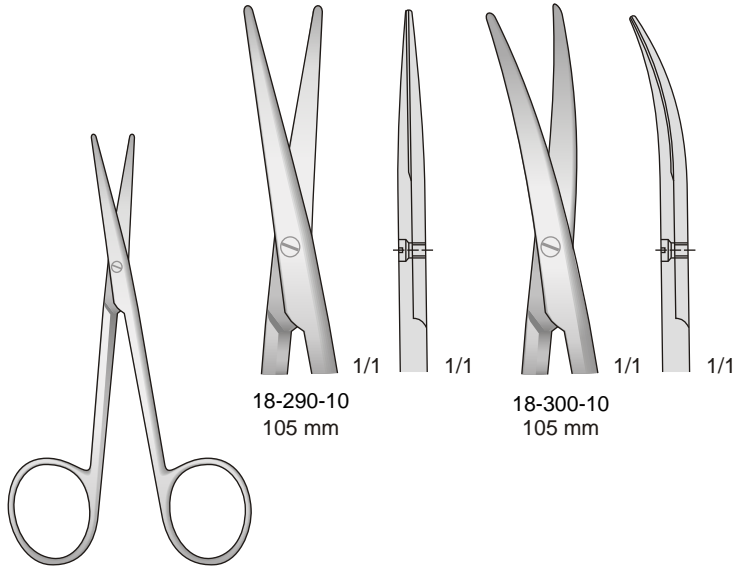

18-290-10
105 mm

18-300-10
105 mm

COTTLE-KNAPP
18-290
105 mm

COTTLE
18-310-11
115 mm

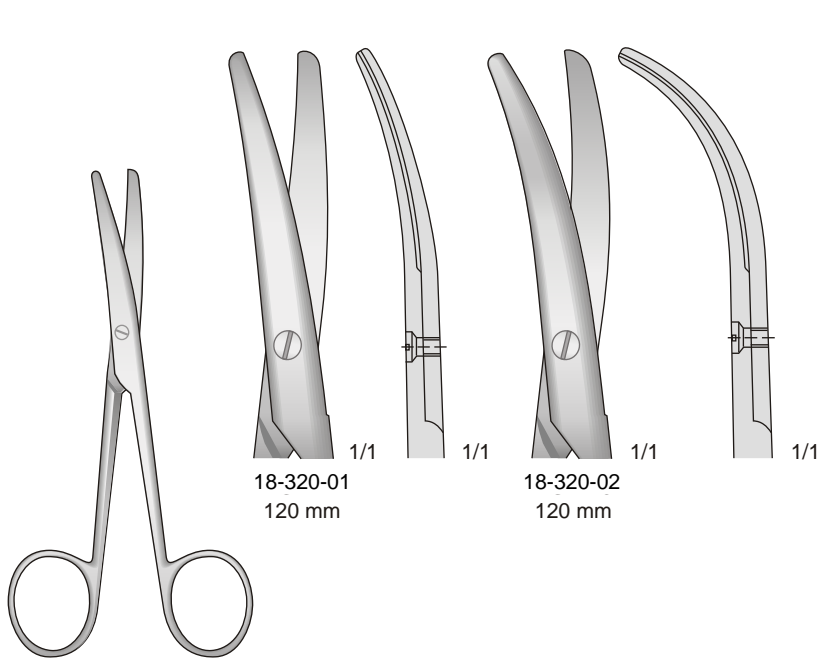

18-320-01
120 mm

18-320-02
120 mm

LANDOLT
18-320
120 mm

SYSTRUNK
18-330-13
130 mm

Spitz
Sharp
Acuta
Aguda
Pointu

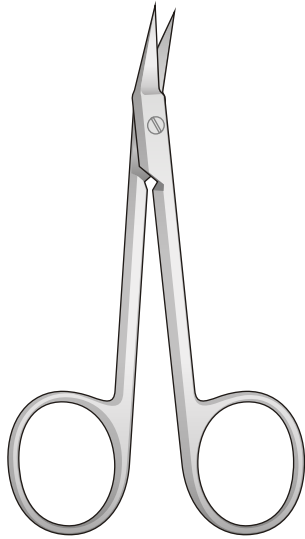

O'BRIEN
18-340-09
95 mm

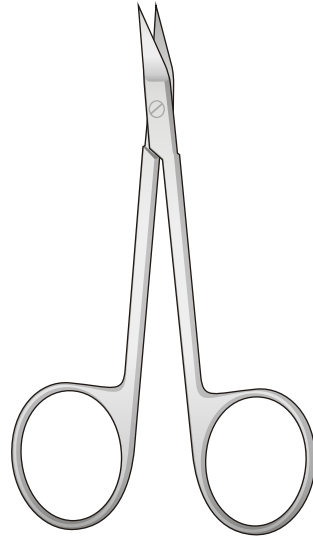

DANIELS
18-350-09
90 mm

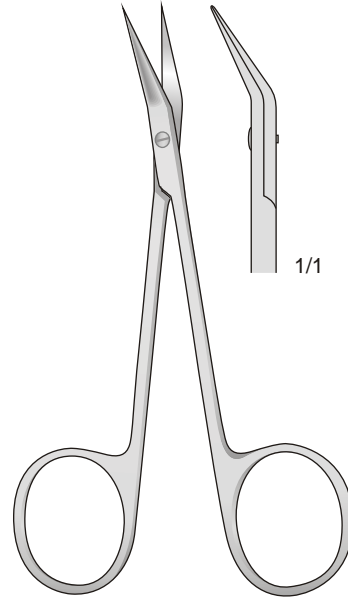

BIRO
18-360-10
100 mm

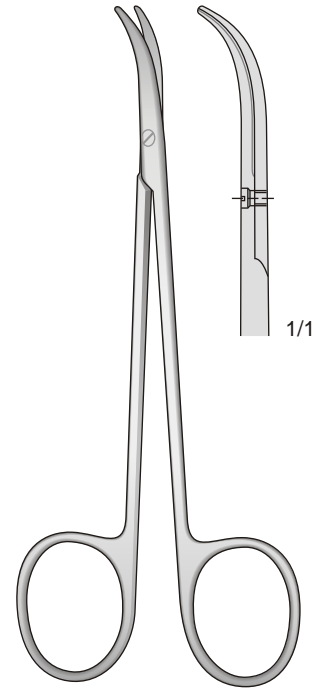

CINELLI
18-370-11
115 mm

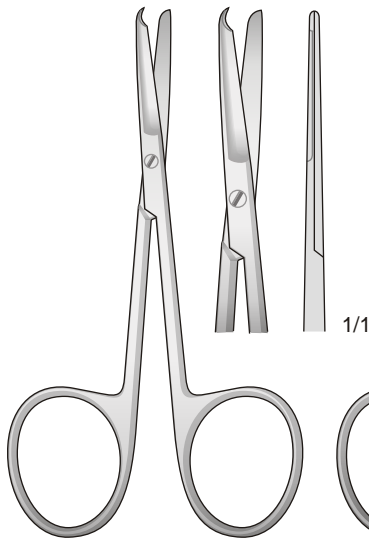

SPENCER
18-380-09
90 mm

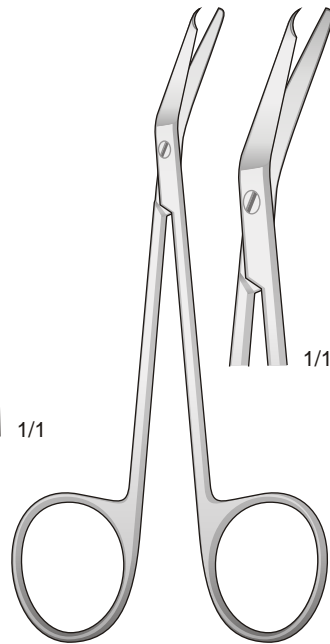

SPENCER
18-390-13
130 mm

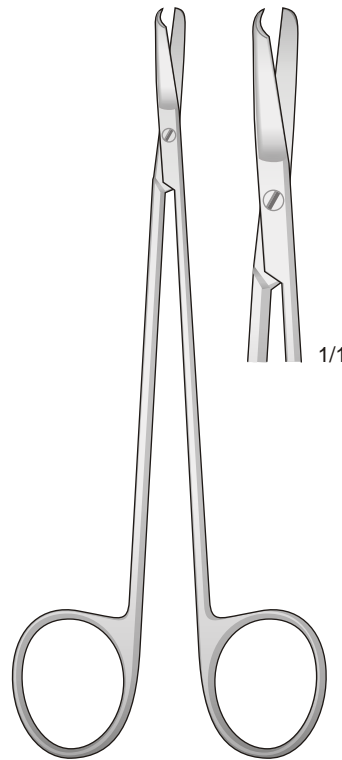

KELLY
18-400-15
150 mm

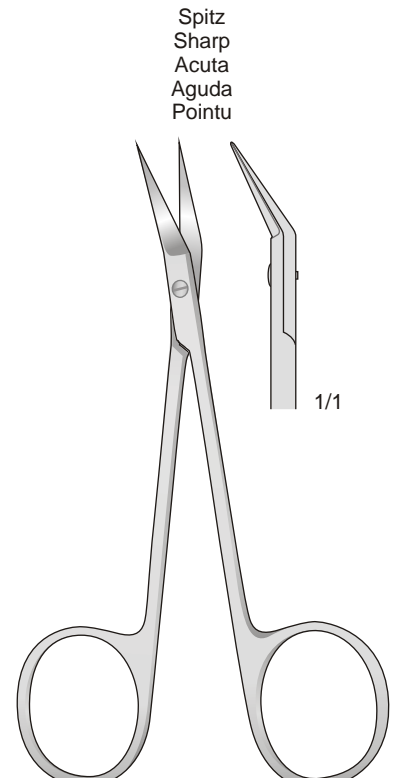

WILMER
18-410-10
105 mm

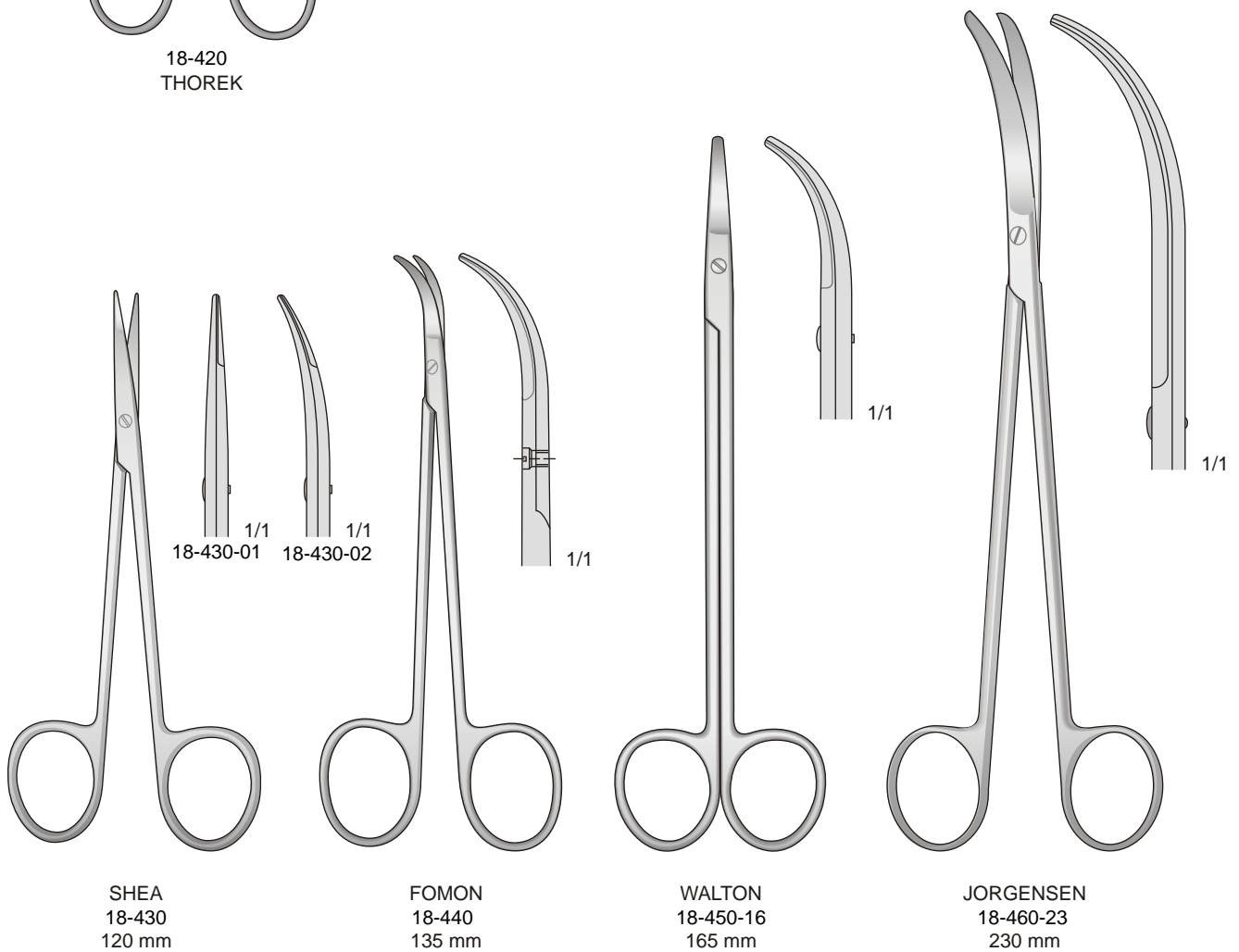

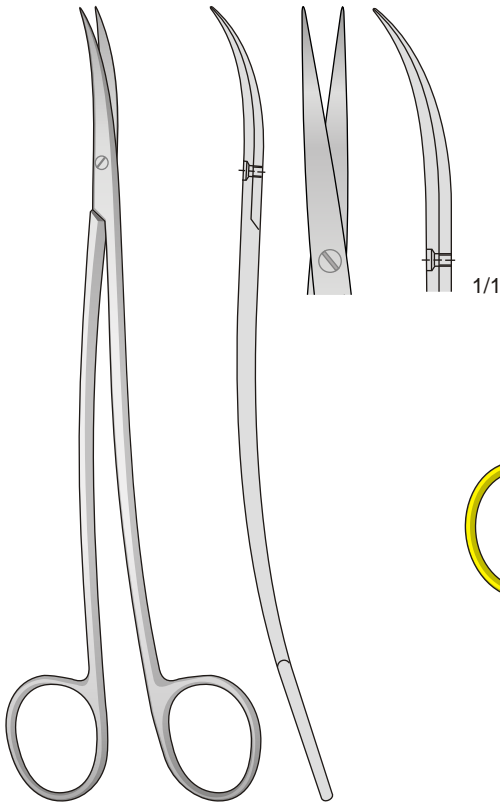

METZENBAUM-FINO
18-470-18 - 180 mm
18-470-20 - 200 mm
18-470-23 - 230 mm

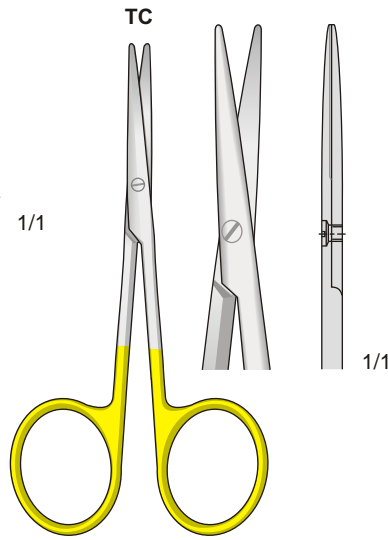

TC
LEXER-BABY
18-480-10
100 mm

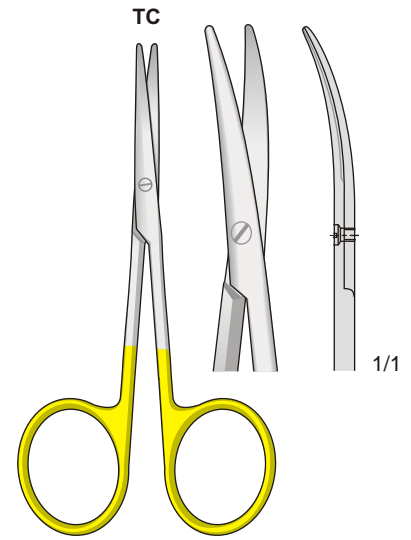

TC
LEXER-BABY
18-490-10
100 mm

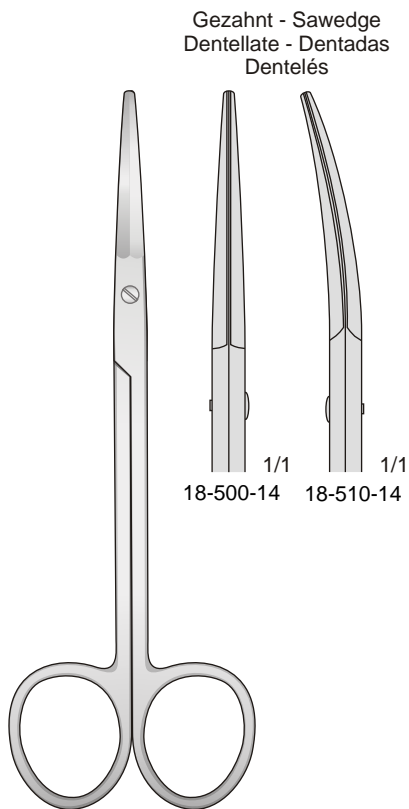

KAHN
18-500-510
145 mm

Gezahnt - Sawedge
Dentellate - Dentadas
Dentelés

18-500-14 1/1 18-510-14 1/1

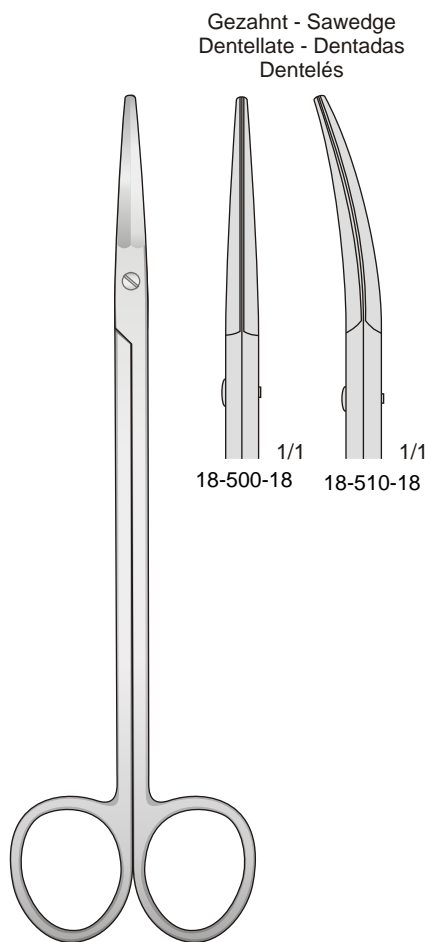

KAHN
18-500-510
180 mm

Gezahnt - Sawedge
Dentellate - Dentadas
Dentelés

18-500-18 1/1 18-510-18 1/1

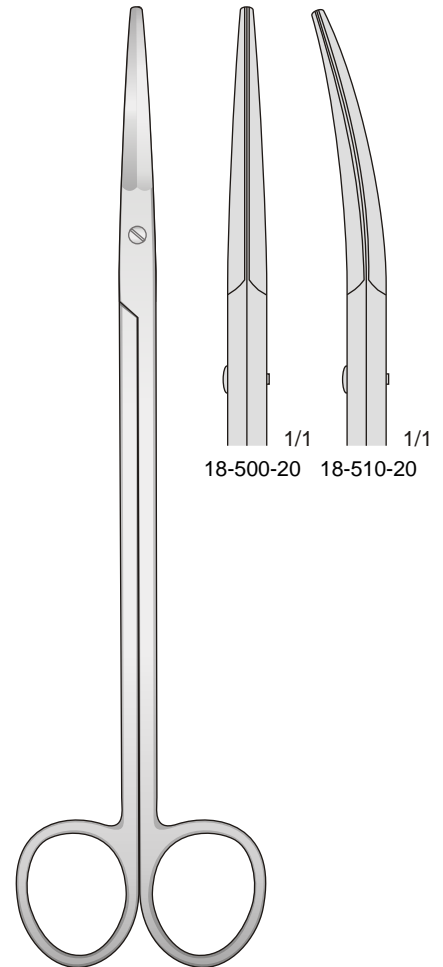

KAHN
18-500-510
205 mm

Gezahnt - Sawedge
Dentellate - Dentadas
Dentelés

18-500-20 1/1 18-510-20 1/1

Eine Schneide gezahnt S-förmig gebogen
One toothed cutting edge S-shaped
Una lama dentata curva a forma S
Una hoja dentada forma S
Une lame dentelée courbés en S

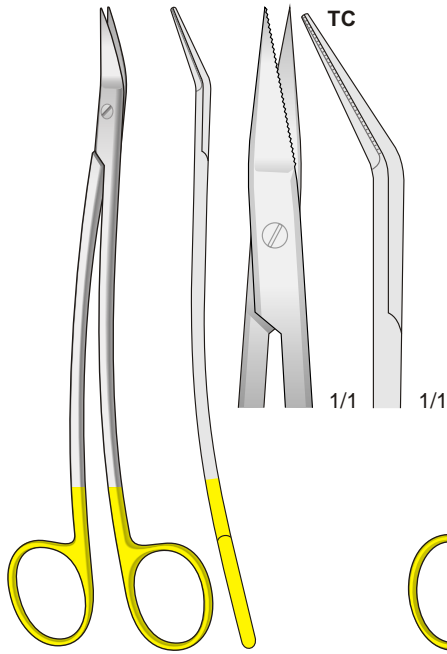

18-520-17
175 mm

TC

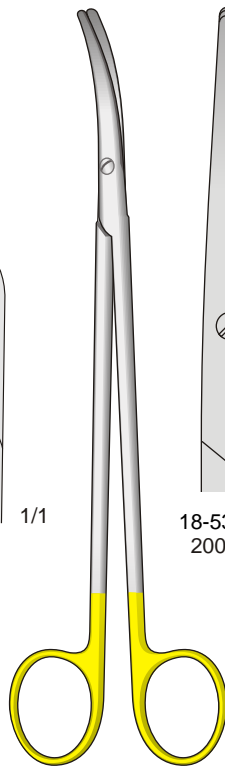

METZENBAUM-THOREK
18-530

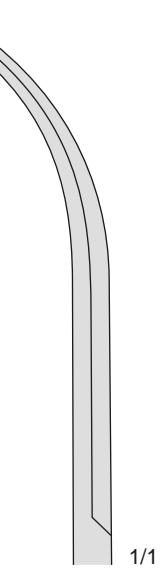
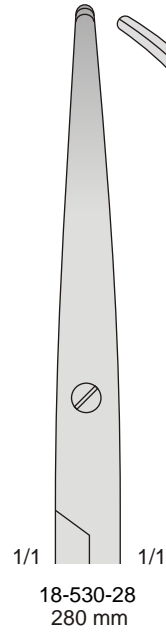
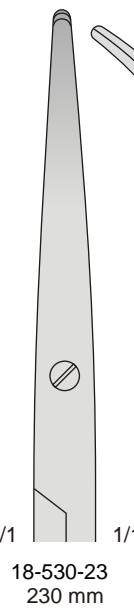
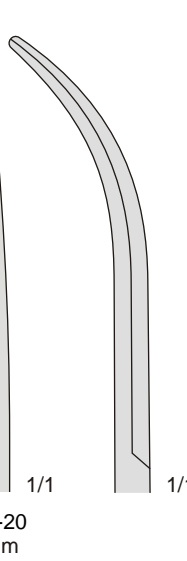
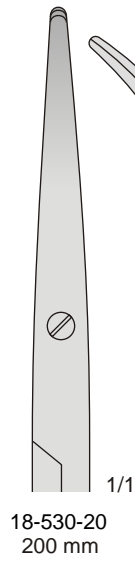

TC

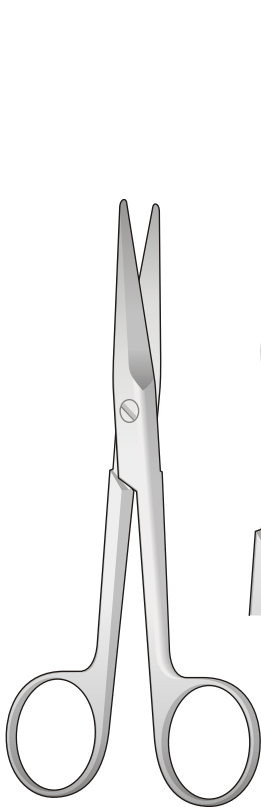

MAYO
18-540
155 mm

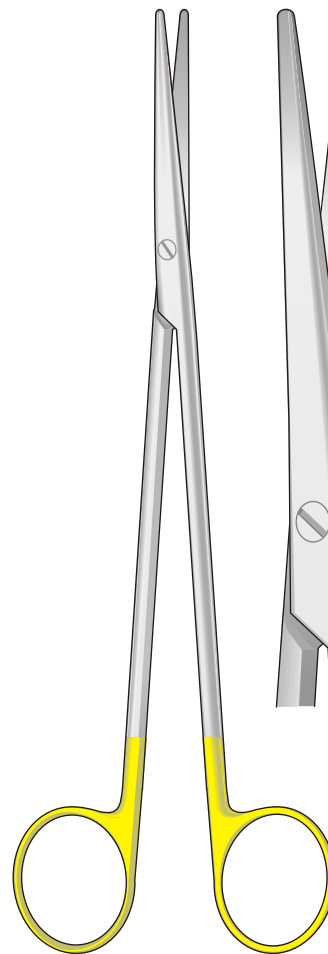
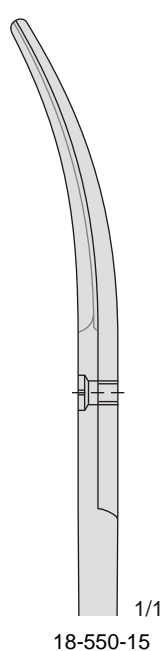
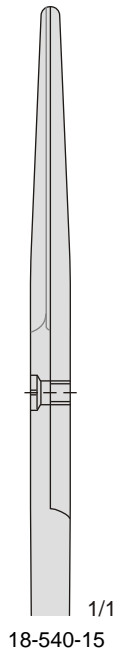
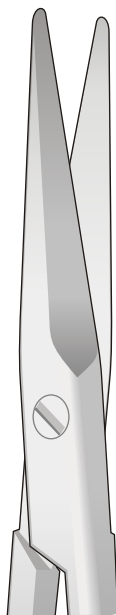

METZENBAUM
18-560
280 mm

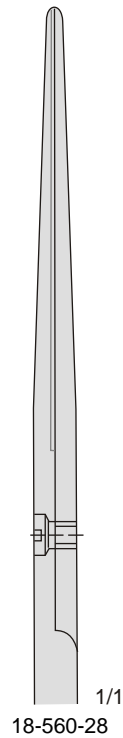
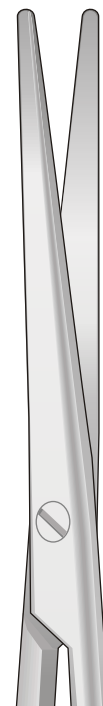

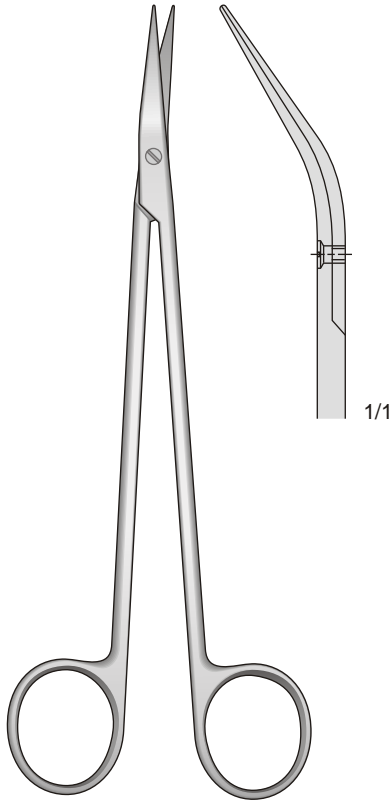

POTTS-SMITH
18-570-17
175 mm

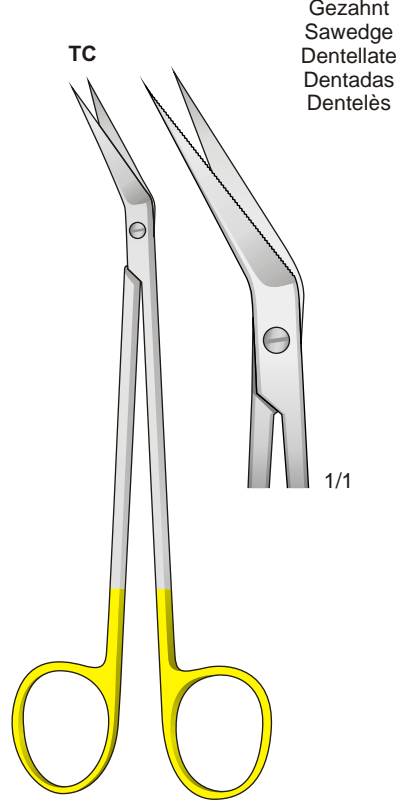

18-580-16
160 mm

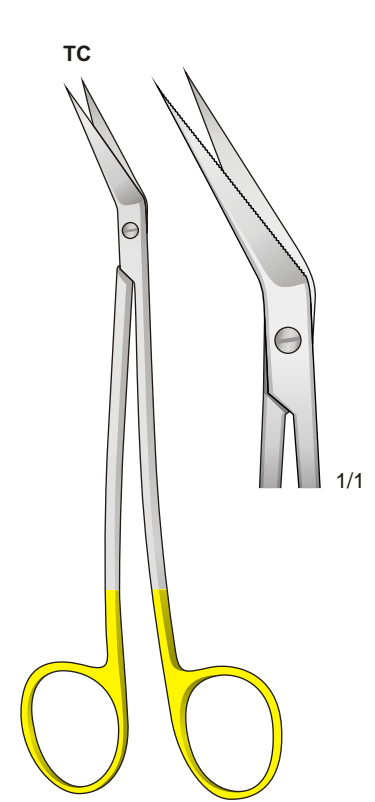

18-590-16
160 mm

Gefäßscheren
Vessel scissors

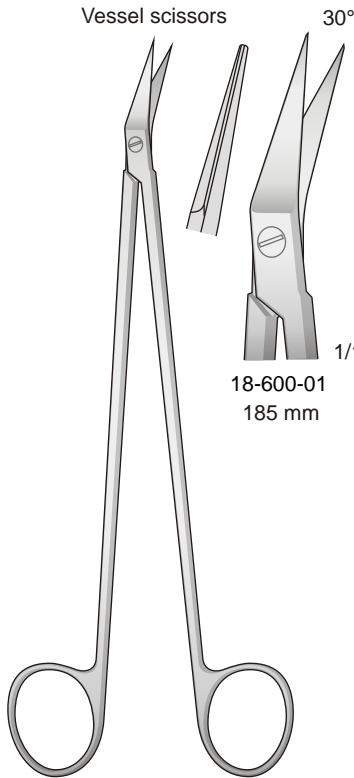

POTTS-DE MARTEL
18-600
185 mm

30°

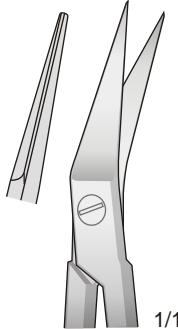

18-600-01
185 mm

45°

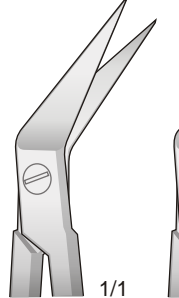

18-600-02
185 mm

60°

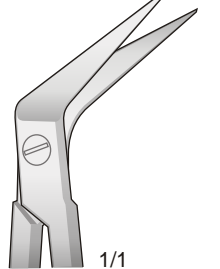

18-600-03
185 mm

Coronararterien-Schere
Coronary artery scissors

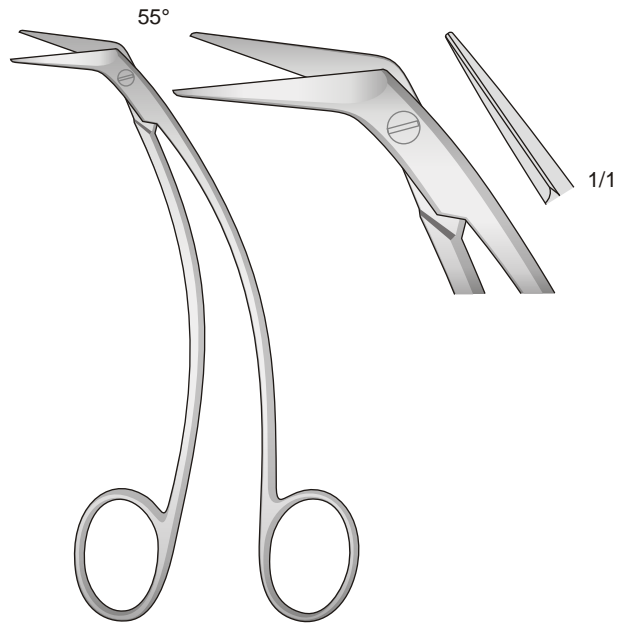

FAVOLORO
18-610-14
140 mm

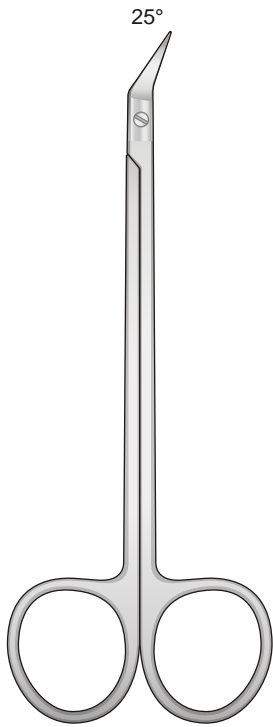

18-620-01
135 mm

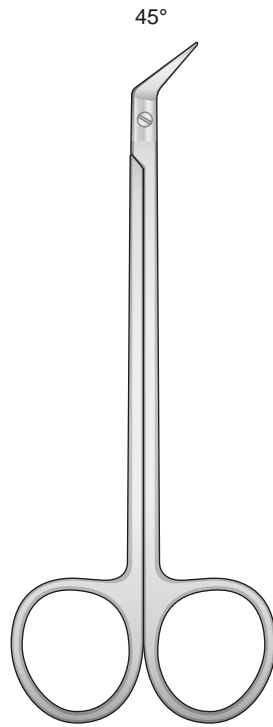

18-620-02
135 mm

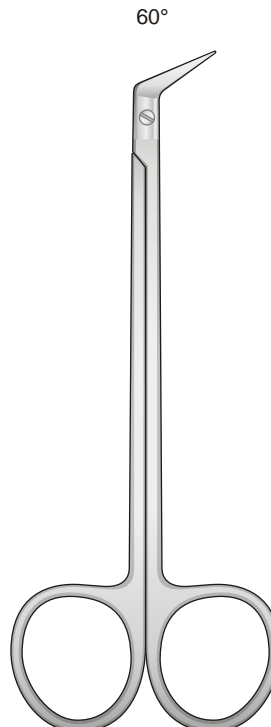

18-620-03
135 mm

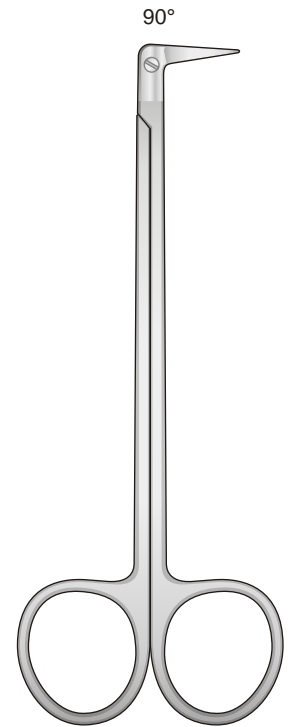

18-620-04
135 mm

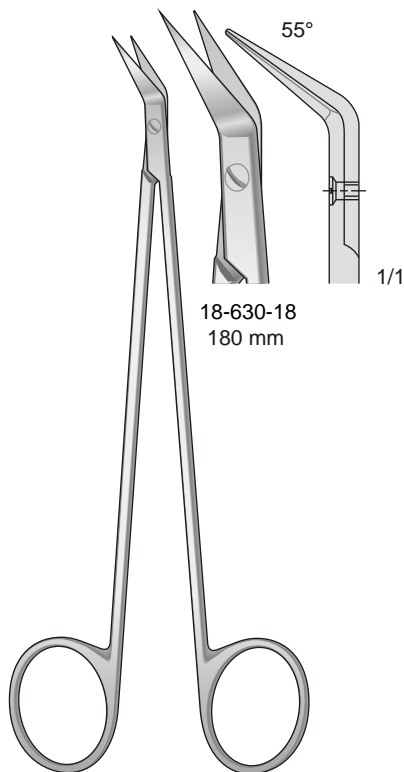

POTTS-SMITH
18-630
180 mm

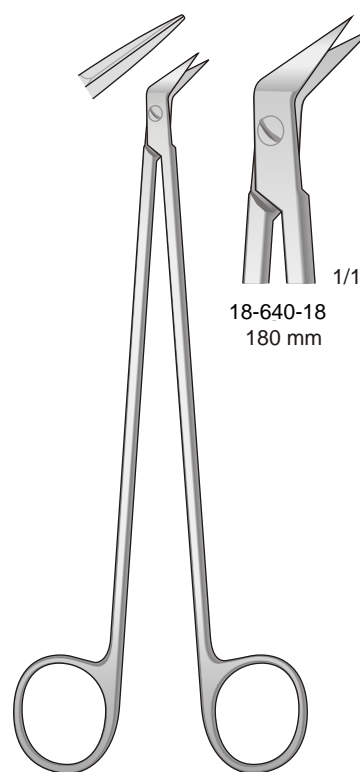

POTTS-SMITH
18-640
180 mm

Gezant - Serrated
Dentellata - Dentadas
Dentelés

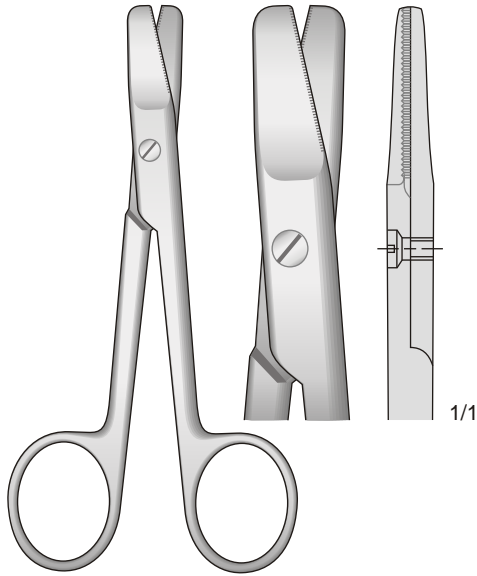

HARVEY
18-650-12
125 mm

Spitz - Sharp
Acuta - Agudo - Aigu



METZENBAUM
18-660
145 mm

Kapselschere
Forbice da cartilagine
Cartilage Scissors

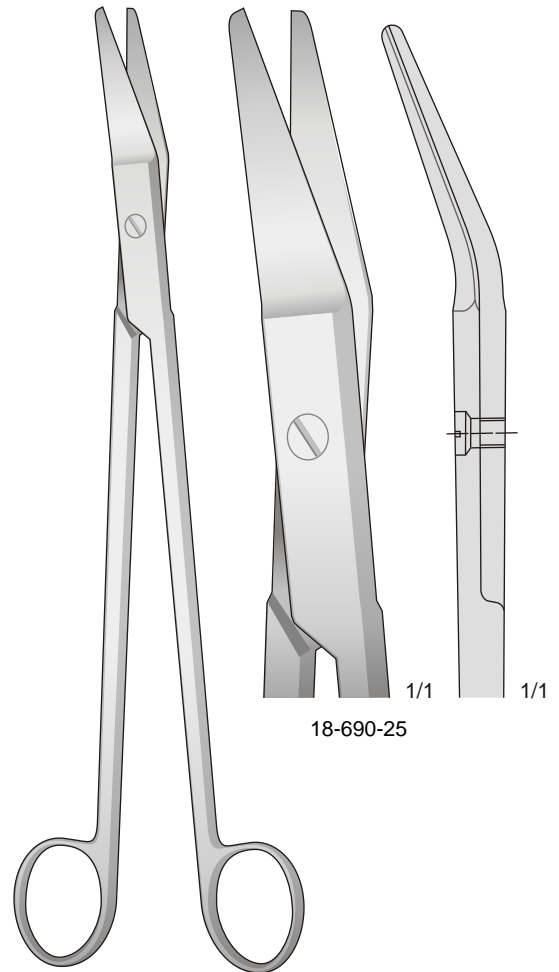

RESANO
18-690
250 mm

Uterusschere
Uterine scissors



BOZEMANN
18-680
220 mm

Gezahn - Serrated
Dentellata - Dentadas - Dentées

TC

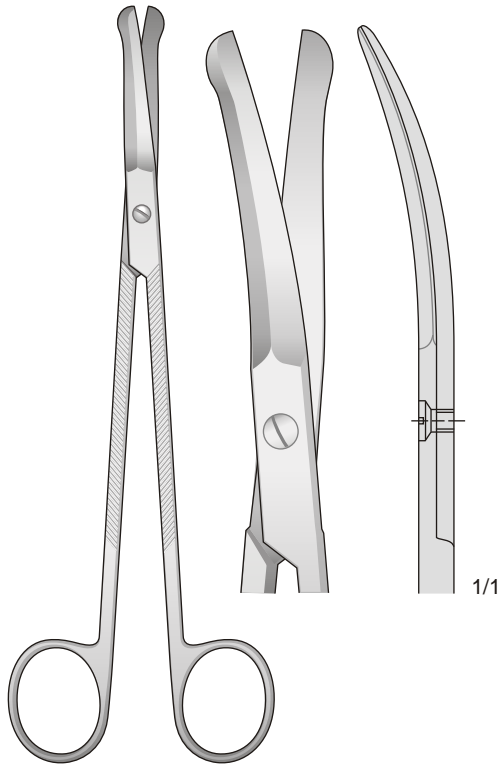

GOOD
18-700-19
195 mm

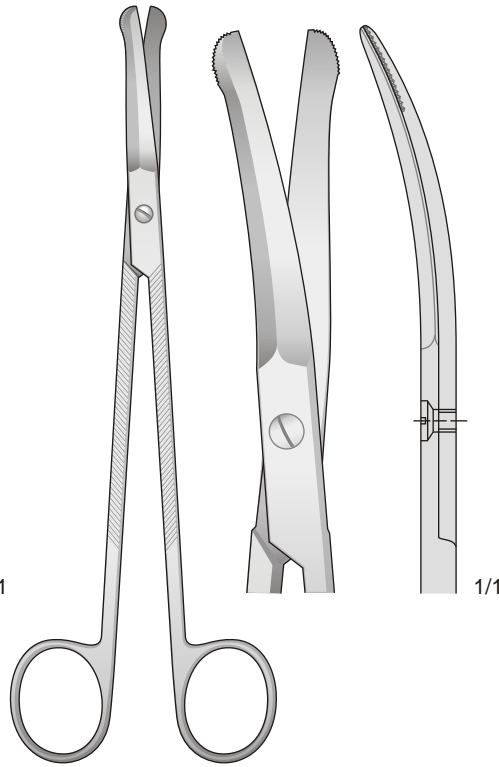

SCHWECKENDIEK
18-710-19
195 mm

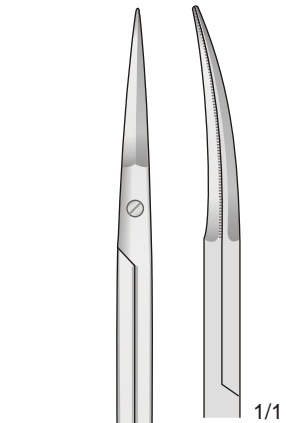

PECK-JOSEPH
18-720-14
140 mm

Stumpf - Blunt
Smussa - Romas
Mousse

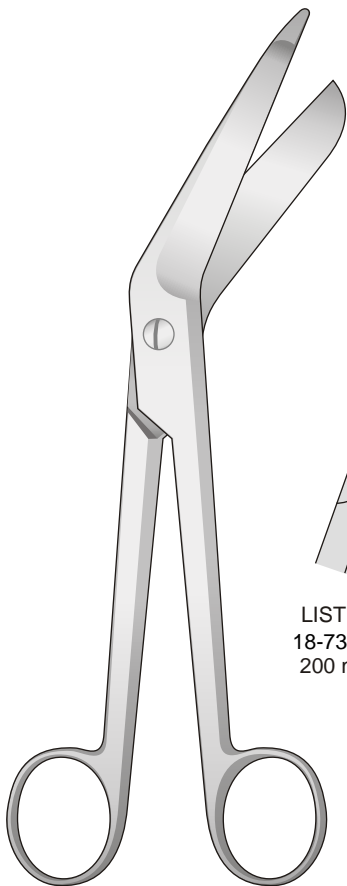

LISTER
18-730-20
200 mm

18-730

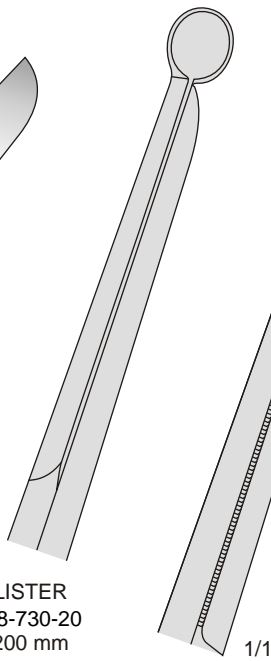

BERGMANN
18-730-23
230 mm

TC

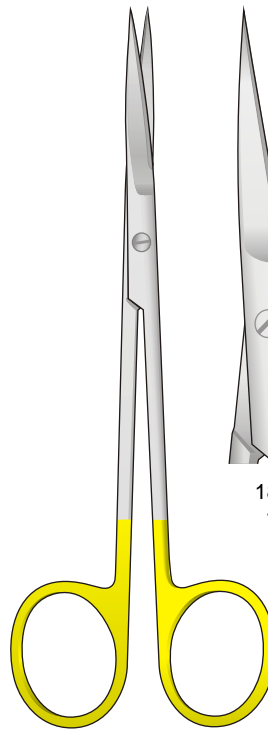

JOSEPH
18-740
150 mm

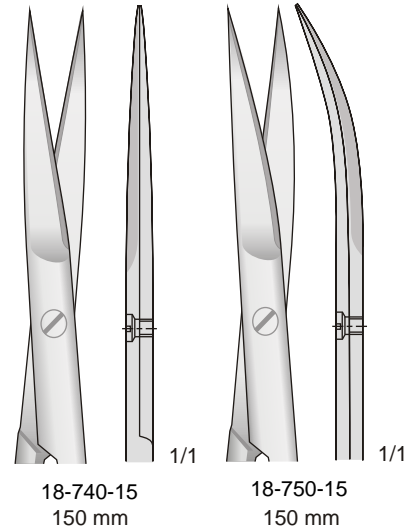

18-740-15
150 mm

18-750-15
150 mm

“Super-cut” scheren micro-schliff für tissue atrauma
 “Super-cut” scissors for gripping tissue and cutting interproximally
 Forbici “super-cut” estremamente taglienti per tessuti con riduzione del trauma
 Tijeras “super cortes” para cortar tissue-atrauma
 Ciseaux “super cut” coupe les tissus en reduisant les risques de traumatisme

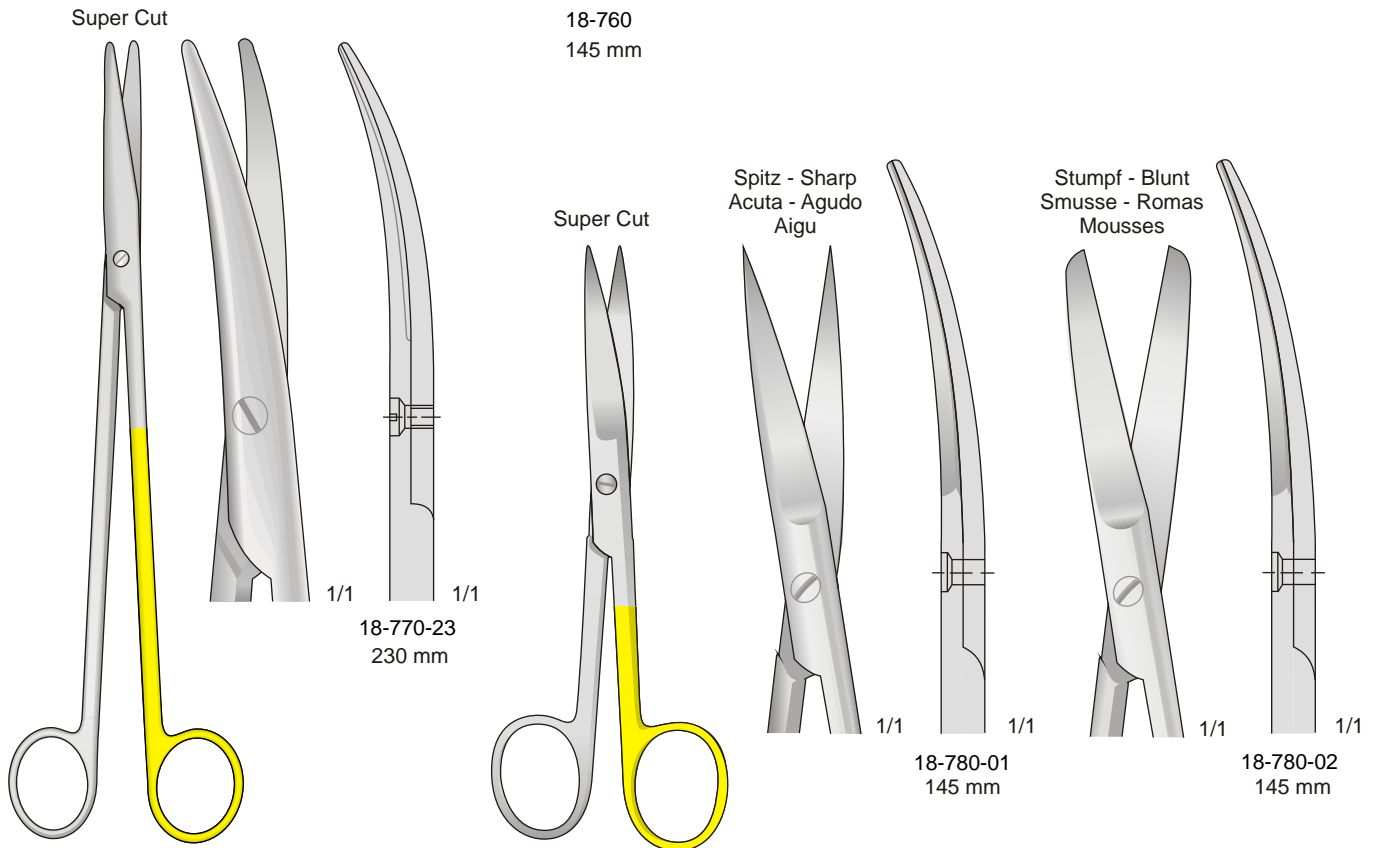
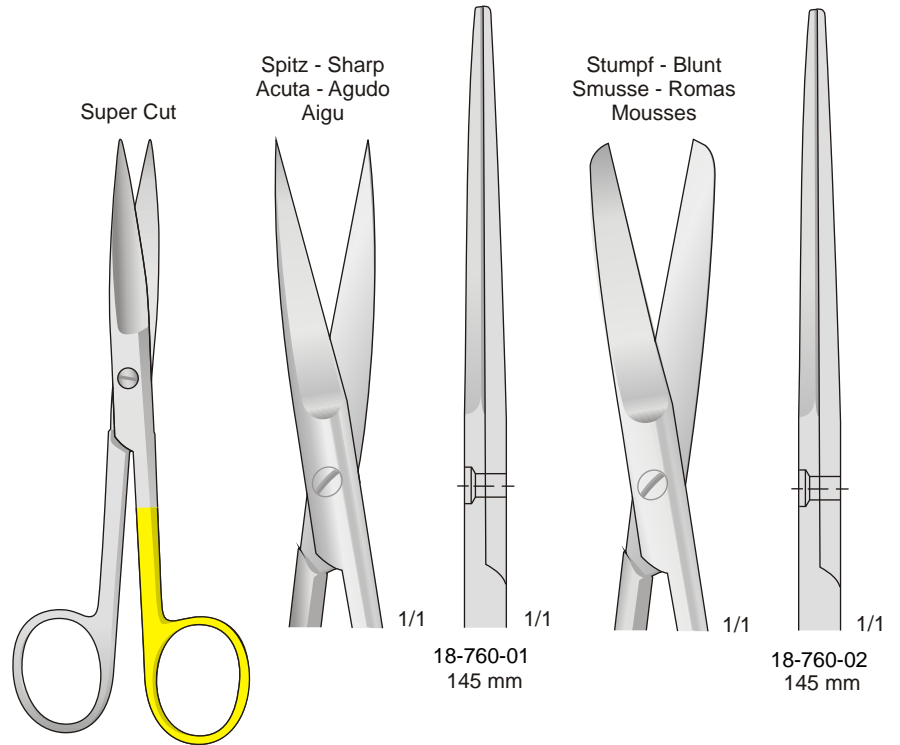

NELSON-METZENBAUM
18-770
230 mm

18-780
145 mm

Mit Hartmetalleinsätzen
Tungsten-carbide scissors
Con punta al carburo di tungsteno
Tijeras de tungsteno
Avec plaquettes en carbure de tungstène

Mit eine Schneide gezahnt
With one blade serrated
Con una lama zigrinata
Con una hoja dentada
Avec lame dentèle

Super Cut
TC

Mit eine Schneide gezahnt
With one blade serrated
Con una lama zigrinata
Con una hoja dentada
Avec lame dentèle

Super Cut
TC

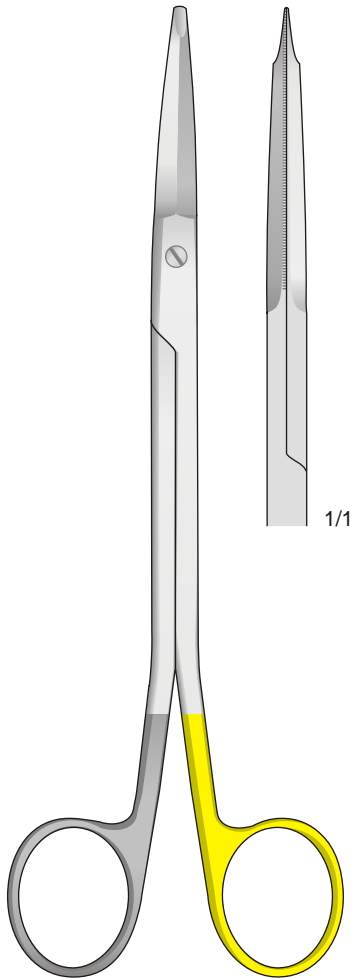

FREEMAN GORNEY
18-790-18
180 mm

Mit eine Schneide gezahnt
With one blade serrated
Con una lama zigrinata
Con una hoja dentada
Avec lame dentèle

Super Cut
TC

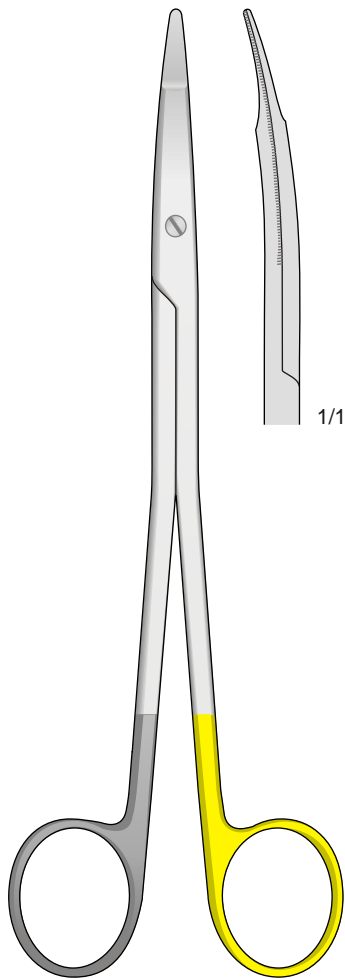

FREEMAN
18-800-18
180 mm

Mit eine Schneide gezahnt
With one blade serrated
Con una lama zigrinata
Con una hoja dentada
Avec lame dentèle

Super Cut
TC

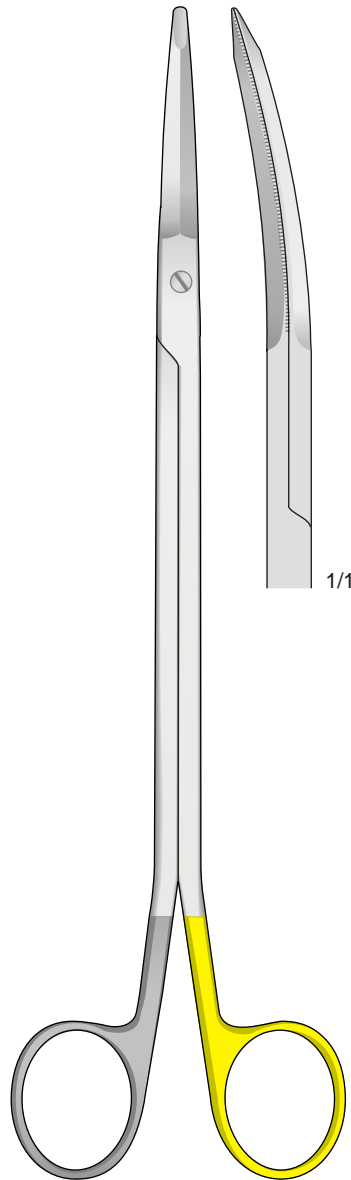

GORNEY
18-810-23
230 mm

Mit eine Schneide gezahnt
With one blade serrated
Con una lama zigrinata
Con una hoja dentada
Avec lame dentèle

Super Cut

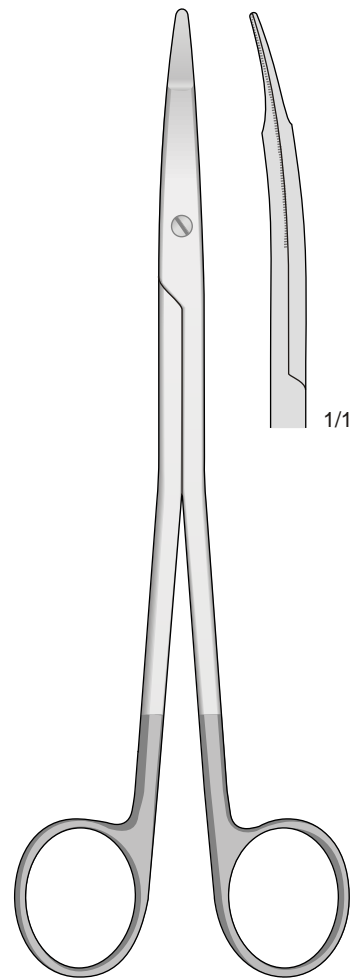

FREEMAN
18-820-18
180 mm

Pinzette mit Häkchen
Suturing Forceps
Pinzette per suture

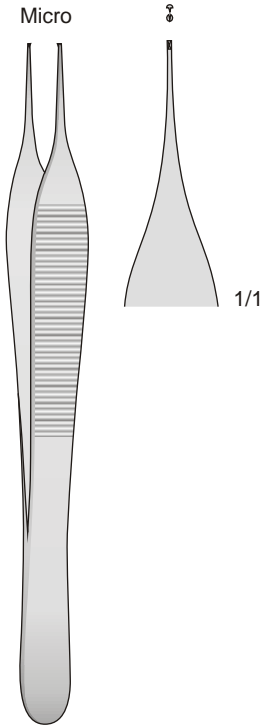

ADSON
18-900-15
150 mm

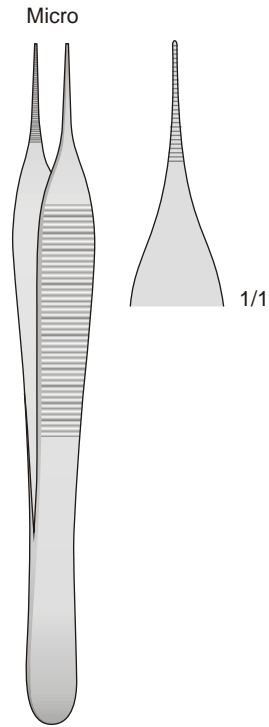

ADSON
18-910-15
150 mm

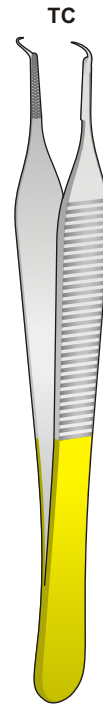

ADSON
18-920-12
125 mm

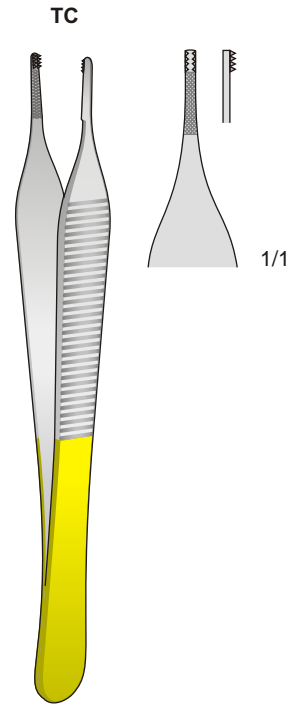

ADSON-BROWN
18-930-12
120 mm

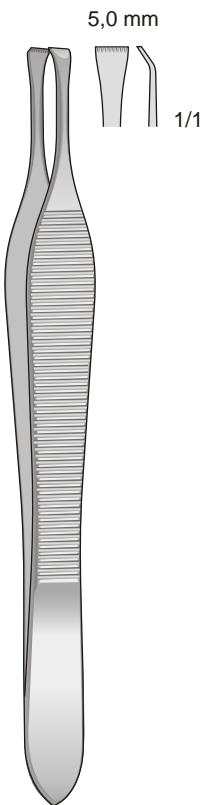

BEASLEY-BABCOCK
18-940-12
120 mm

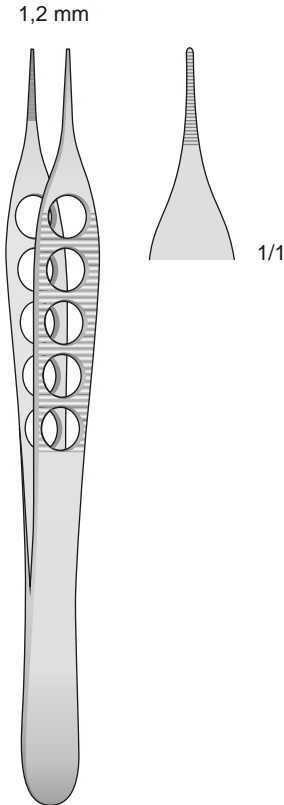

ADSON
18-950-01
120 mm

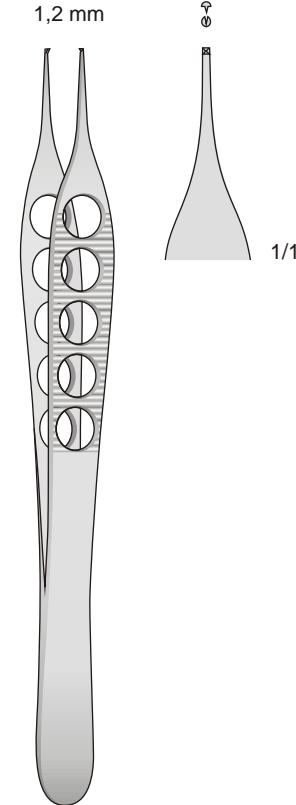

ADSON
18-950-02
120 mm

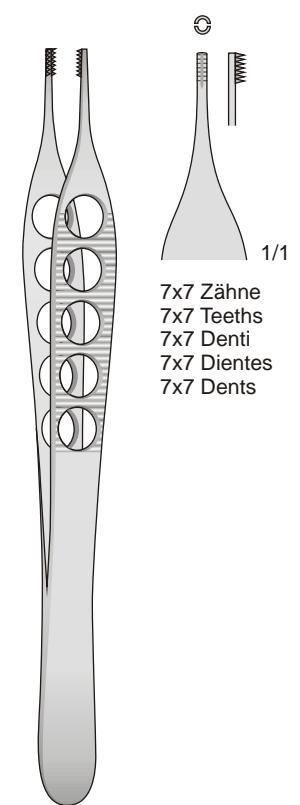

ADSON-BROWN
18-960-12
120 mm

7x7 Zähne
7x7 Teeths
7x7 Denti
7x7 Dientes
7x7 Dents

TC



DE BAKEY
18-970

Mikroprofil - Micro profile
Perfil micro - Perfil micro - Profil micro
2.0 mm

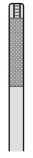

18-970-16
160 mm

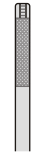

18-970-20
200 mm



18-970-24
245 mm

TC



GERALD
18-980
175 mm



18-980-01
175 mm



18-980-02
175 mm

1x2 Zähne
1x2 Teeth
1x2 Denti
1x2 Dientes
1x2 Dents

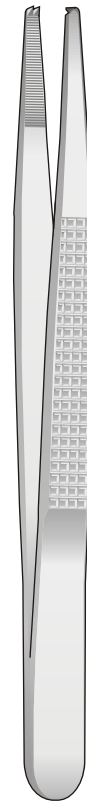

BONNEY
18-990
180 mm

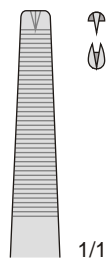

18-990-01
180 mm

1x2 Zähne
1x2 Teeth
1x2 Denti
1x2 Dientes
1x2 Dents



McINDOE
18-1000
150 mm

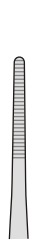

18-1000-01
150 mm



18-1000-02
150 mm



GILLIES
18-1010
150 mm

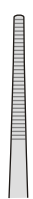

18-1010-01
150 mm



18-1010-02
150 mm



LANE
18-1020



18-1020-01
150 mm

1x2 Zähne
1x2 Teeth
1x2 Denti
1x2 Dientes
1x2 Dents



18-1020-02
150 mm

2x3 Zähne
2x3 Teeth
2x3 Denti
2x3 Dientes
2x3 Dents

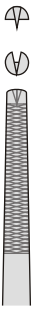

18-1020-03
175 mm

1x2 Zähne
1x2 Teeth
1x2 Denti
1x2 Dientes
1x2 Dents

Titan - Titanium - Titanio - Titane

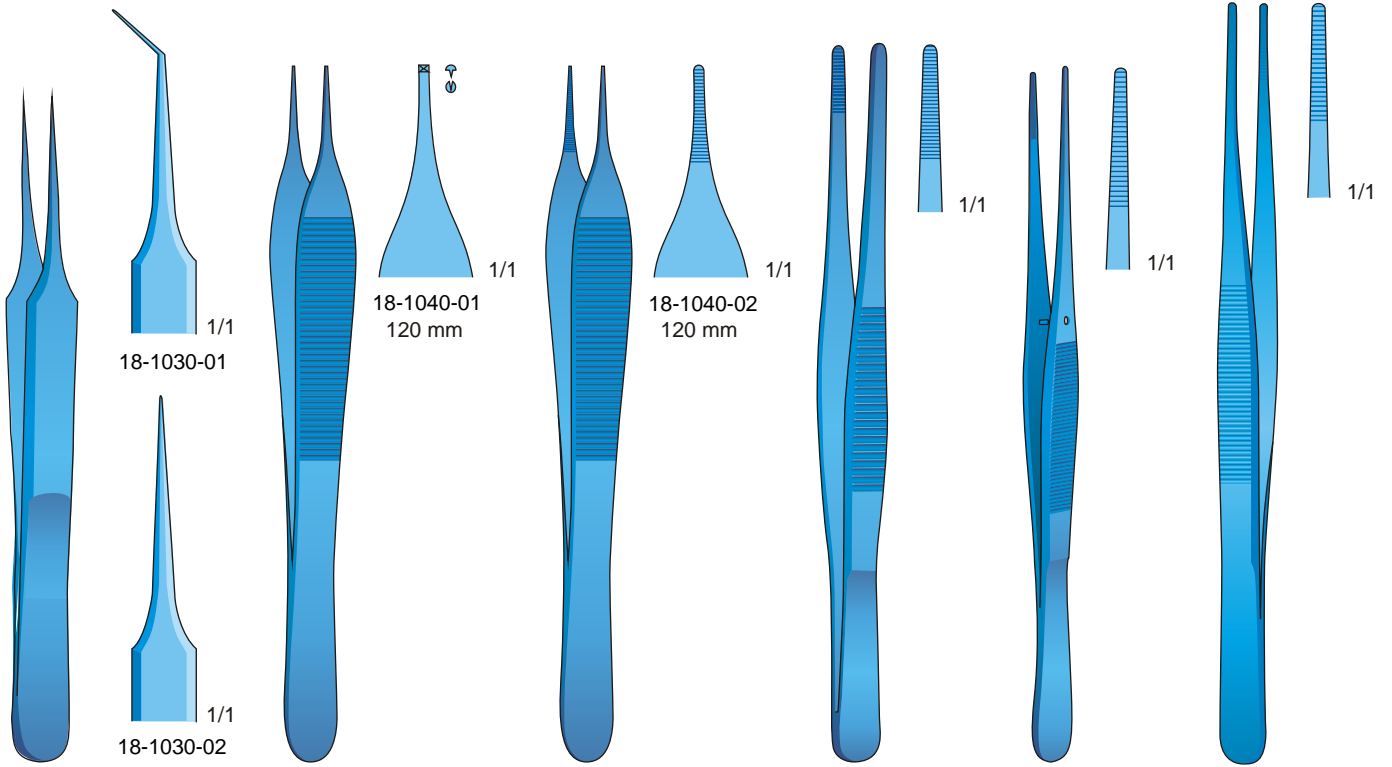

18-1030
110 mm

ADSON
18-1040
120 mm

ADSON
18-1040
120 mm

18-1050-14
145 mm

18-1060-13
130 mm

18-1070-16
160 mm

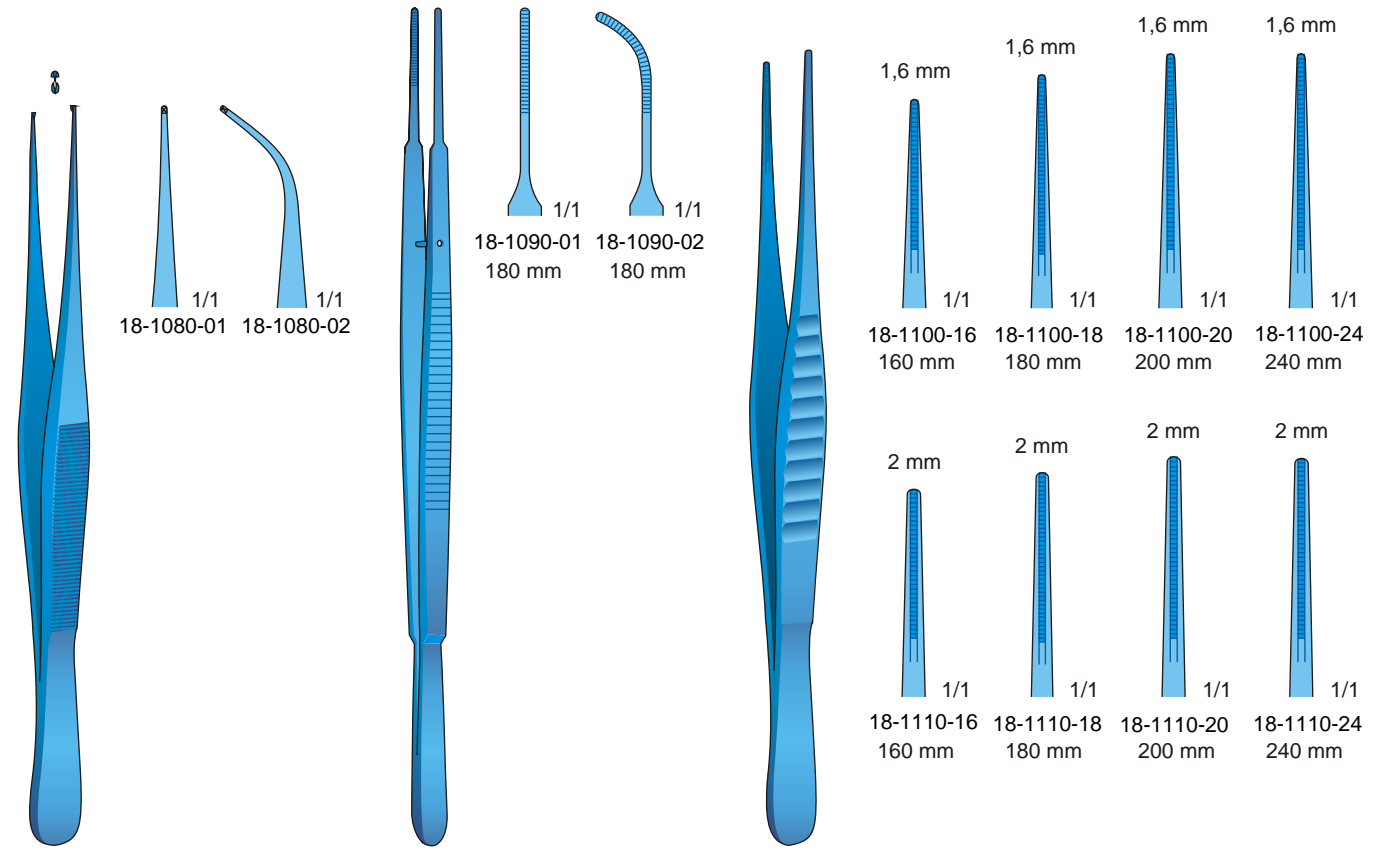

18-1080
110 mm

GERALD
18-1090
180 mm

DE BAKEY
18-1100

		1,6 mm	1,6 mm
		1,6 mm	1,6 mm
18-1100-16	18-1100-18	18-1100-20	18-1100-24
160 mm	180 mm	200 mm	240 mm
		2 mm	2 mm
		2 mm	2 mm
18-1110-16	18-1110-18	18-1110-20	18-1110-24
160 mm	180 mm	200 mm	240 mm

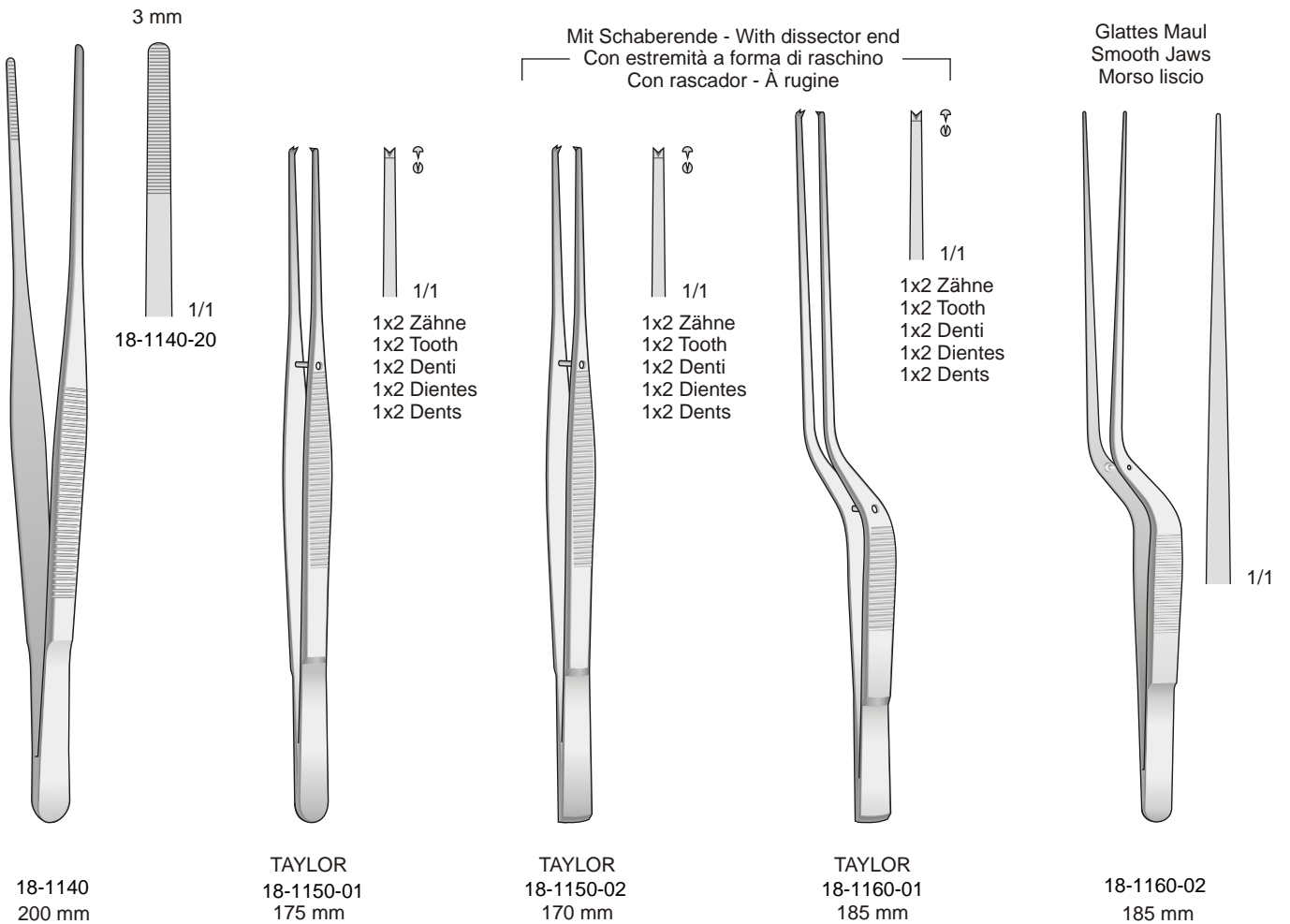
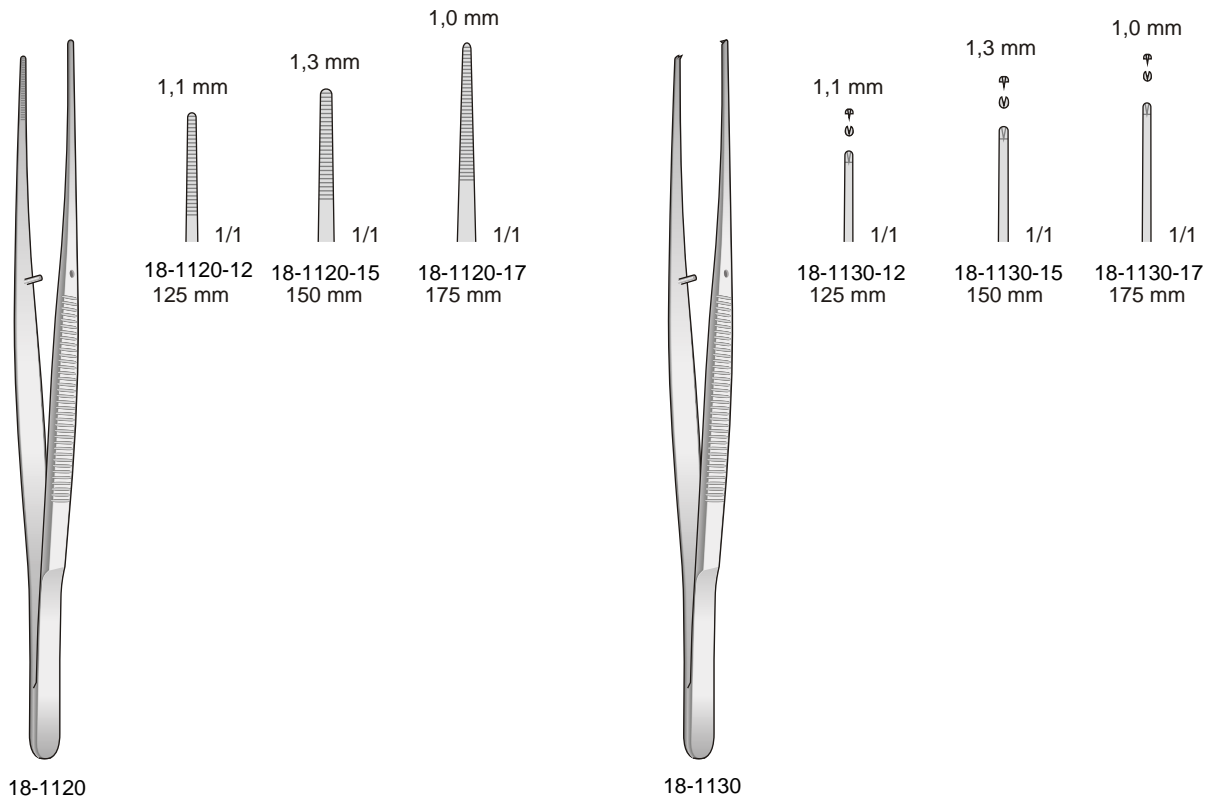

Isoliert - Insulated - Isolate - Aislante - Isolant
Monopolar - Monopolari

new

mit sterilisierfähiger Kunststoff-Isolierbeschichtung - with autoclavable plastic coated insulated handles
con rivestimento isolante in plastica sterilizzabile - con recubrimiento aislante de materia plàstica esterilizabile
à enduit plastique isolant, stérilisable

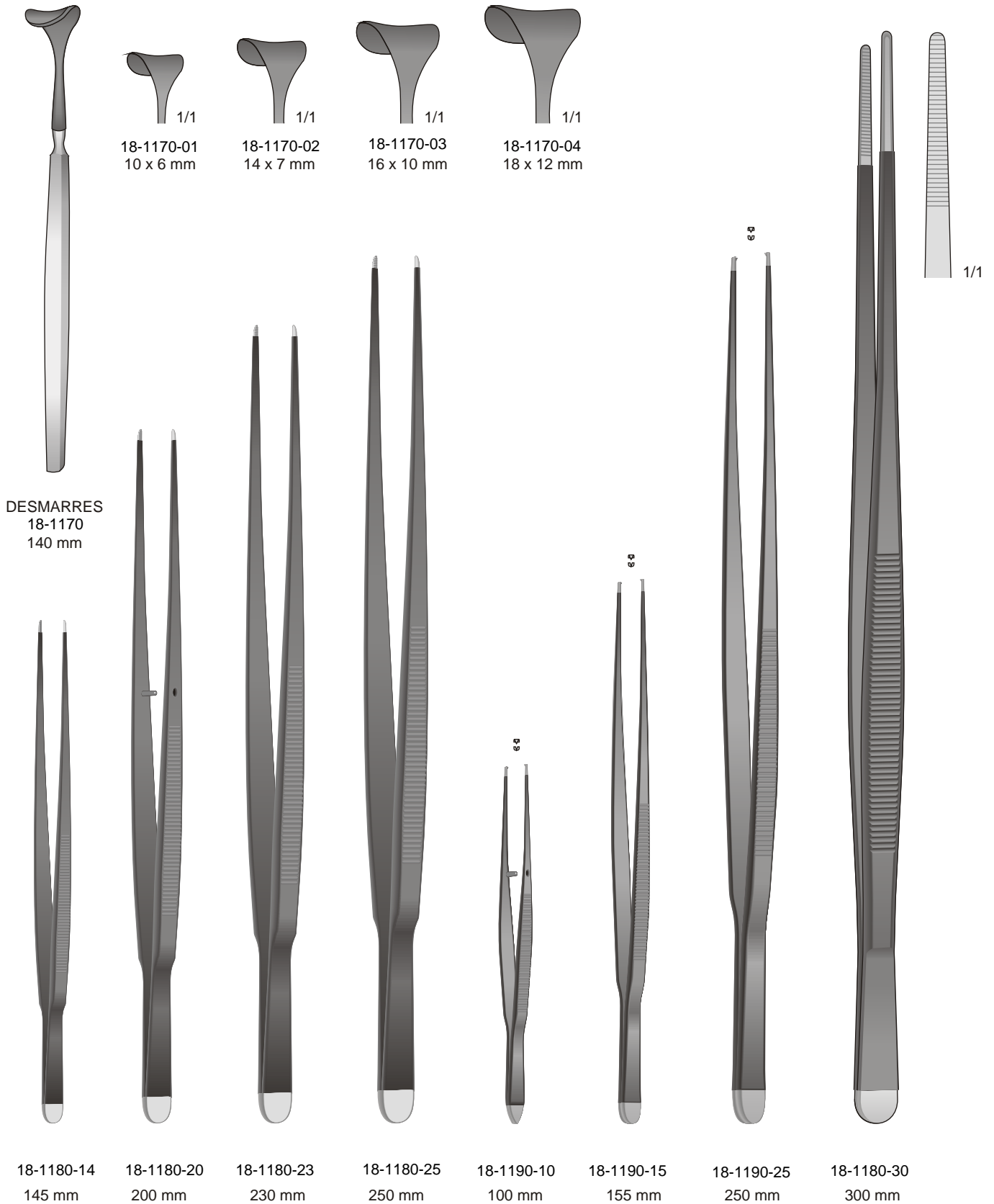

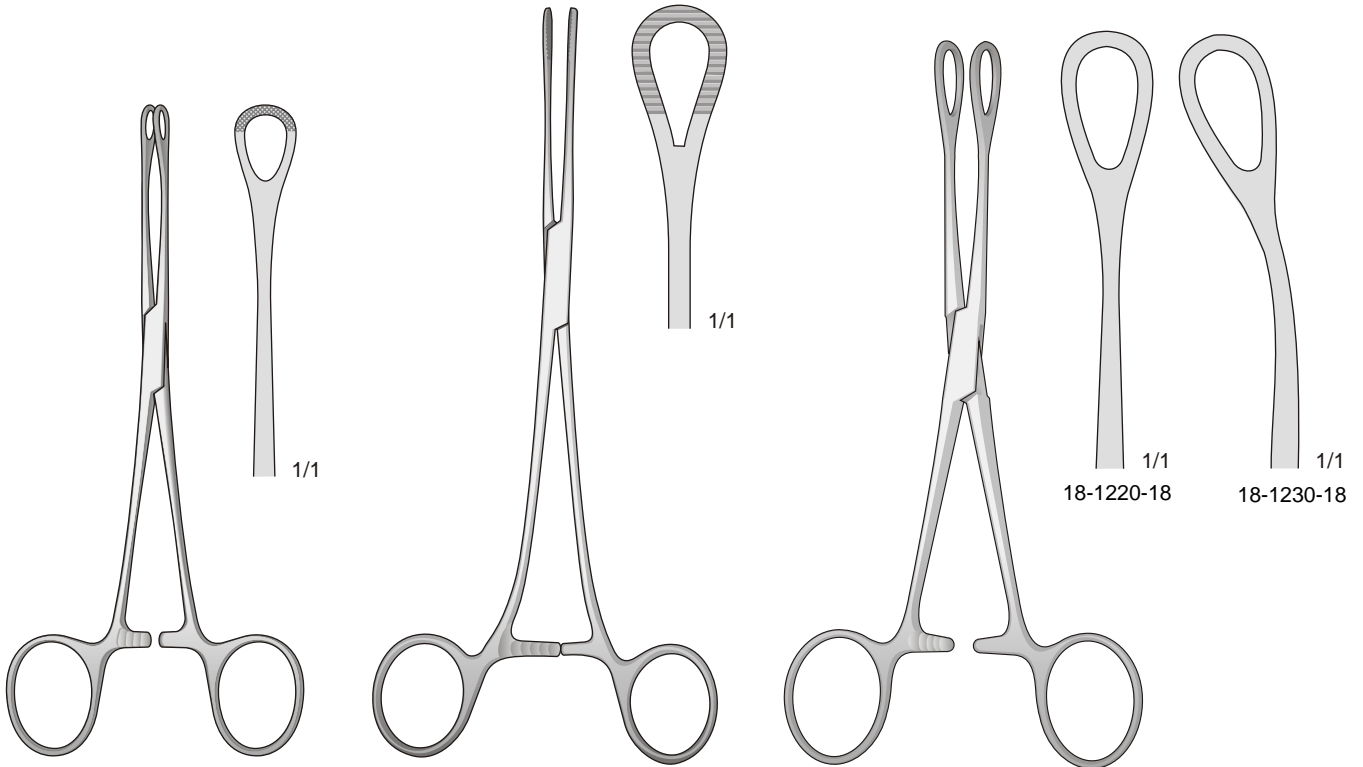

WILLIAMS
18-1200-16
165 mm

18-1210-20
200 mm

FOERSTER
18-1220-230
180 mm

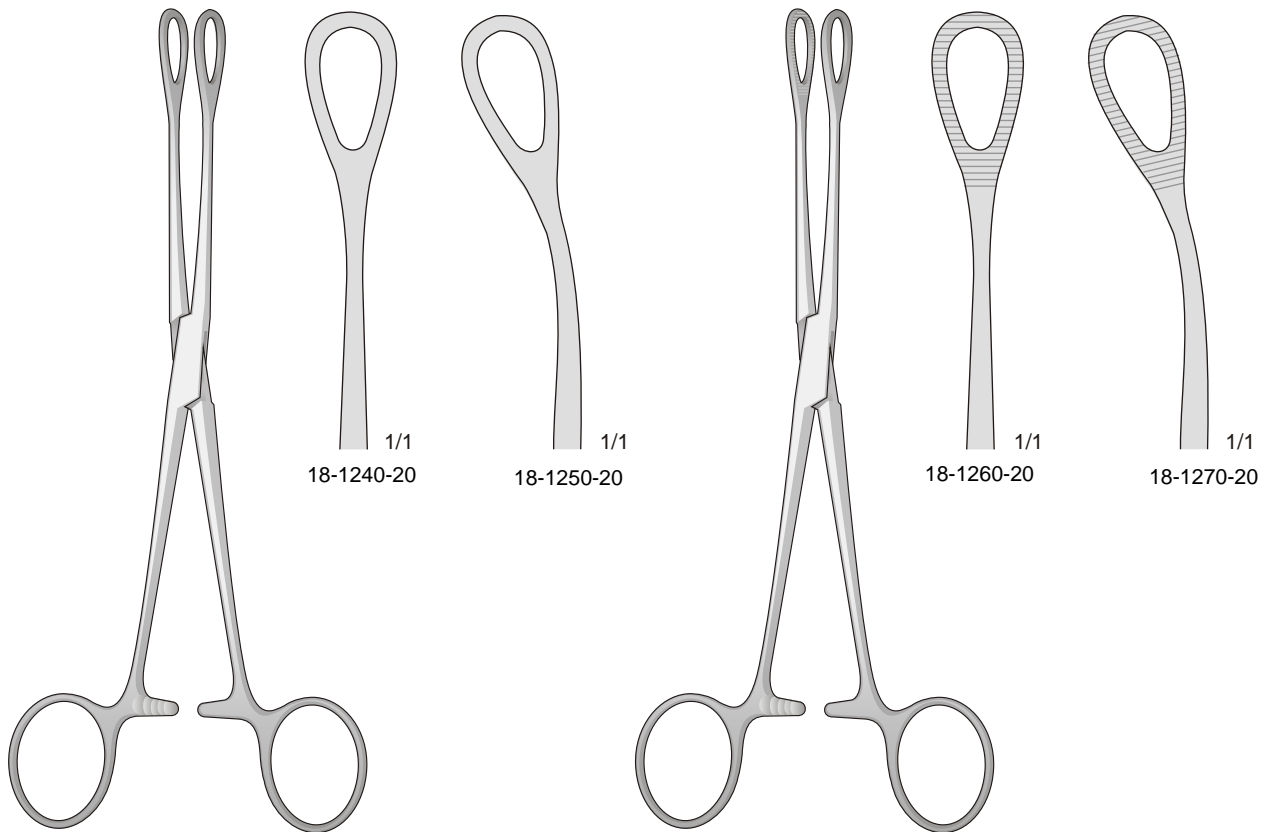

FOERSTER
18-1240-1250
200 mm

FOERSTER
18-1250/1270
200 mm

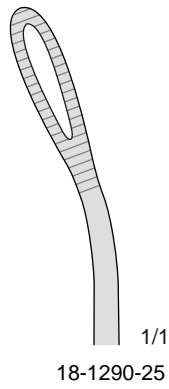
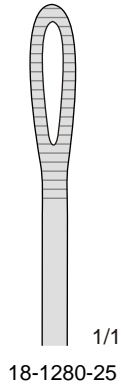
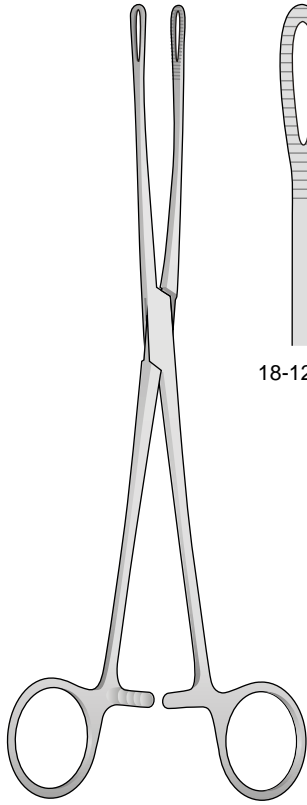

FOERSTER
18-1280/1290
250 mm

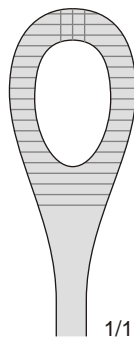
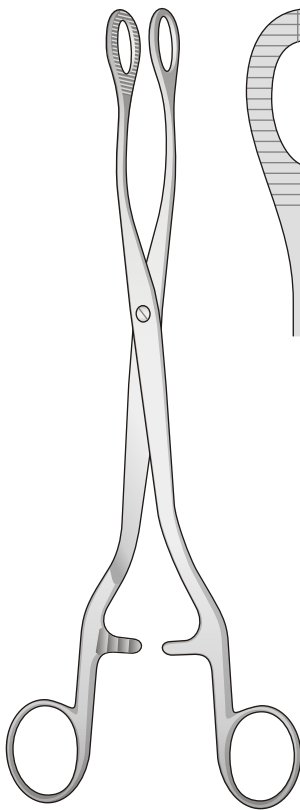

HEYWOOD-SMITH
18-1300-25
250 mm

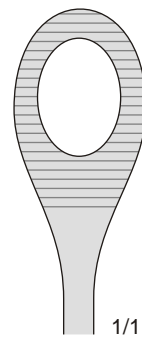
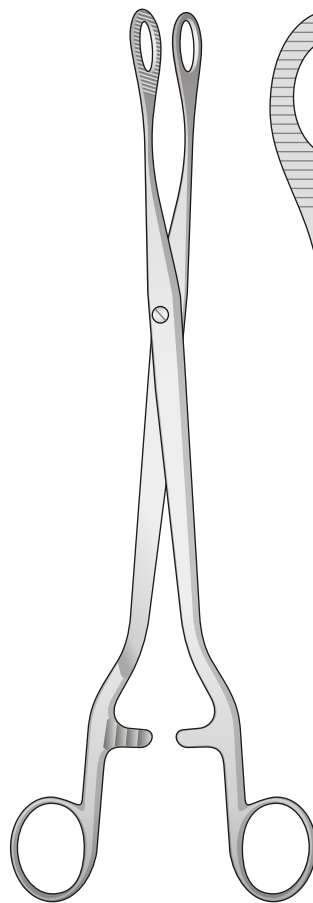

NOTO
18-1310-28
280 mm

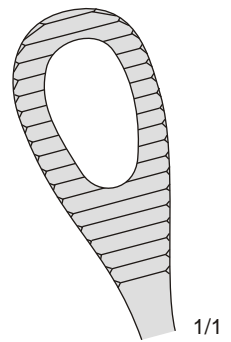
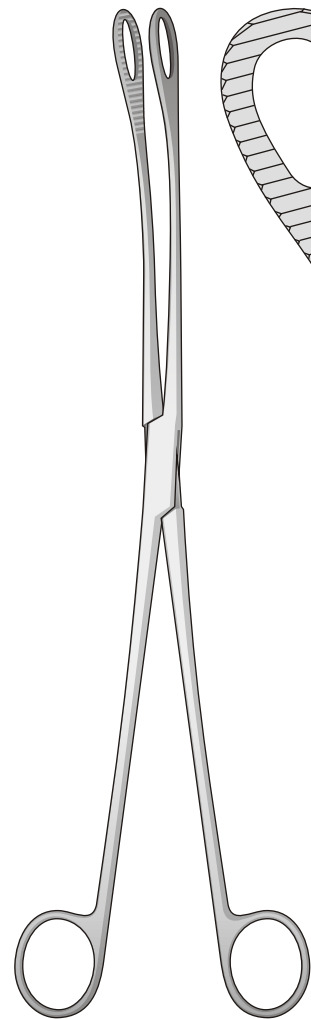

KELLY
18-1320-32
320 mm

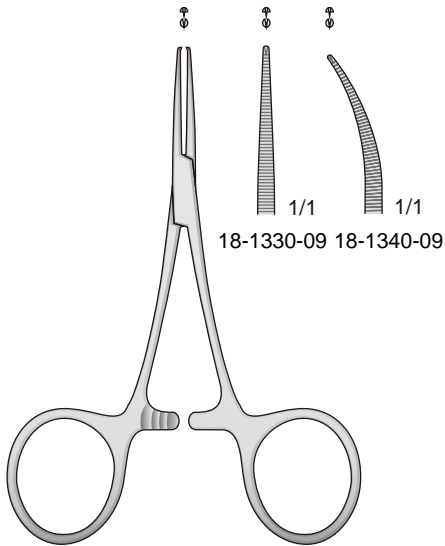

HARTMANN-BABY-MOSQUITO
18-1330/1340
95 mm

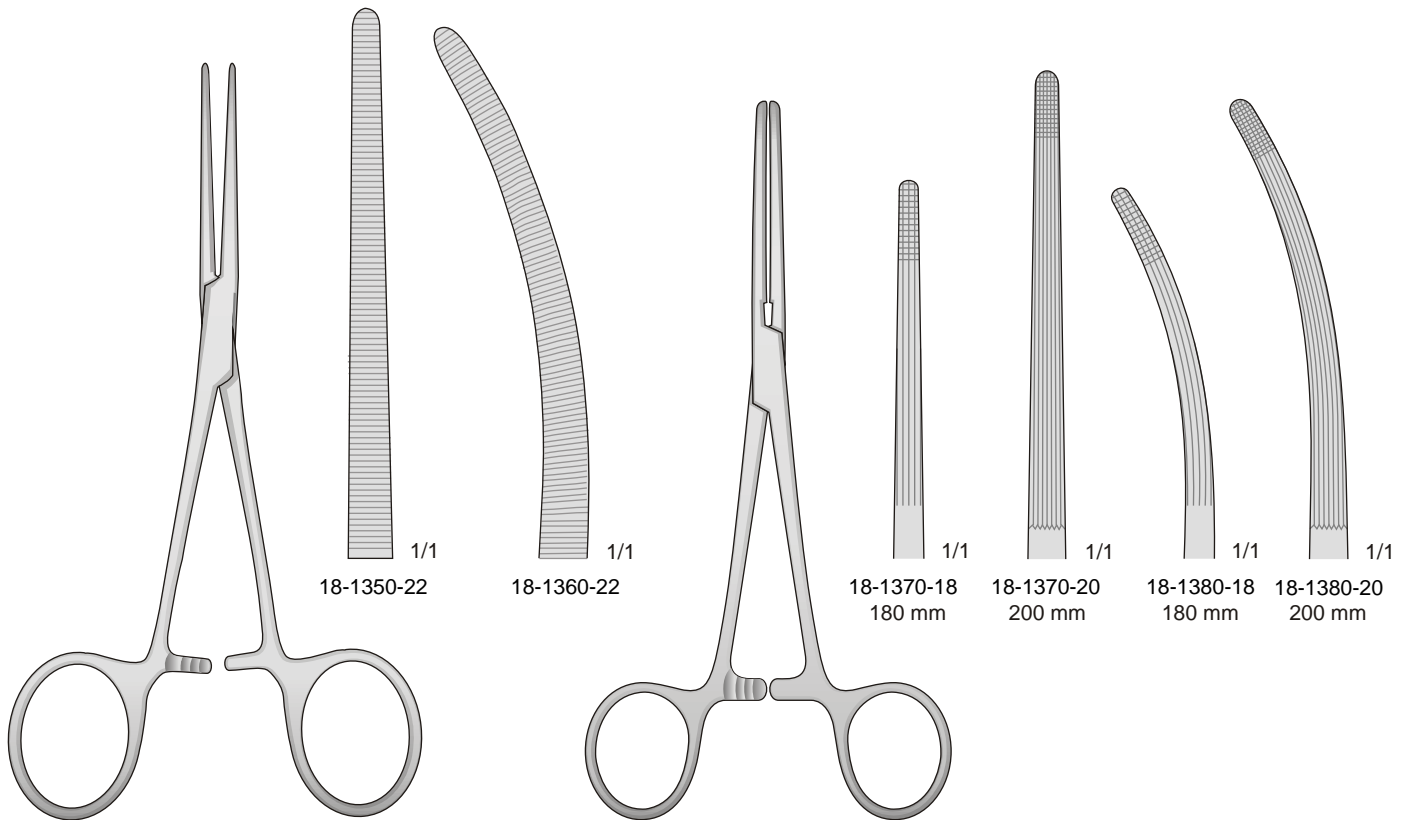

ROCHESTER-PEAN
18-1350/1360
225 mm

ROCHESTER-CARMALT
18-1370/1380

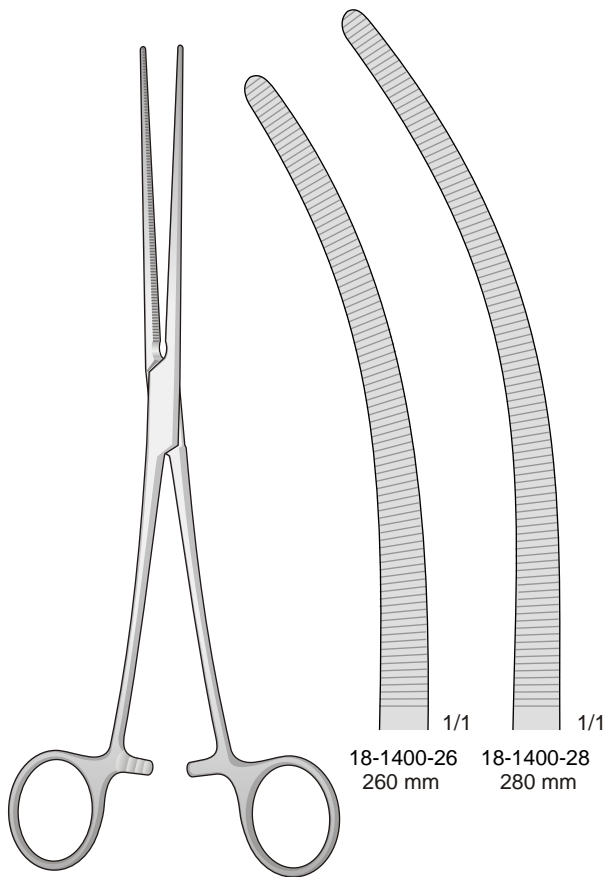
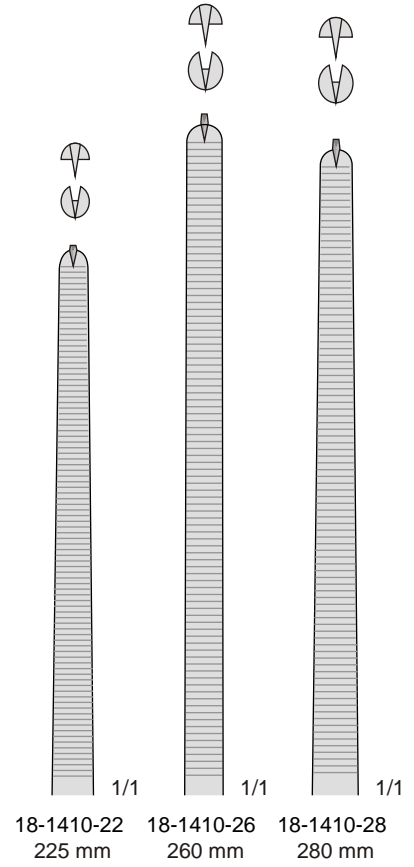
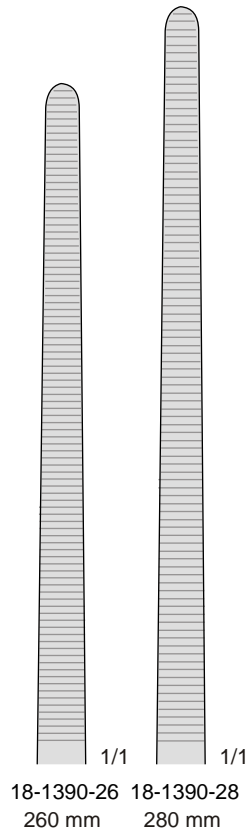

PEAN
18-1390/1400

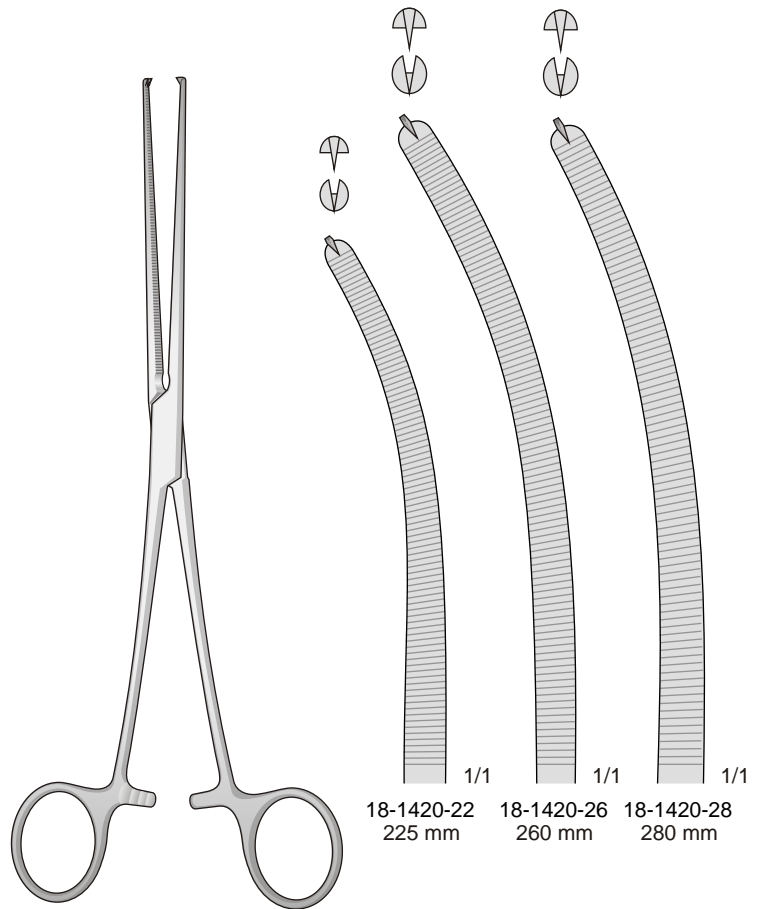

KOCHER-OCHSNER
18-1410/1420

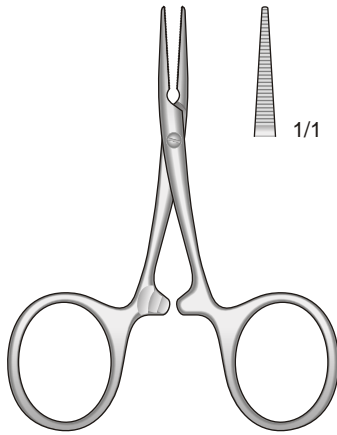

CARREL
18-1430-08
85 mm

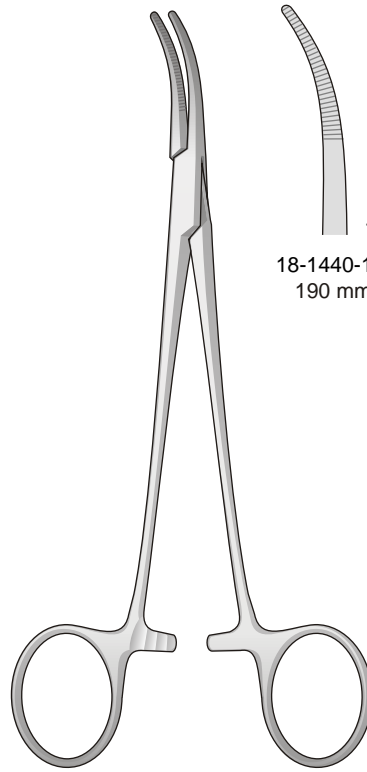

SCHNIDT
18-1440/1450
190 mm

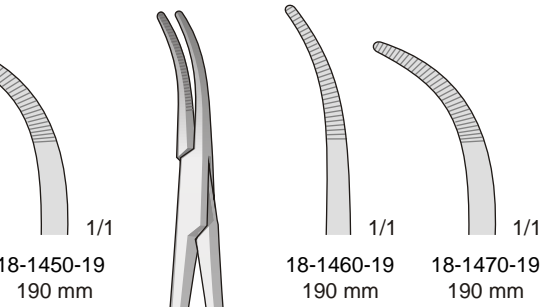
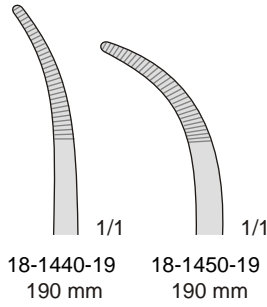

SCHNIDT
18-1460/1470
190 mm

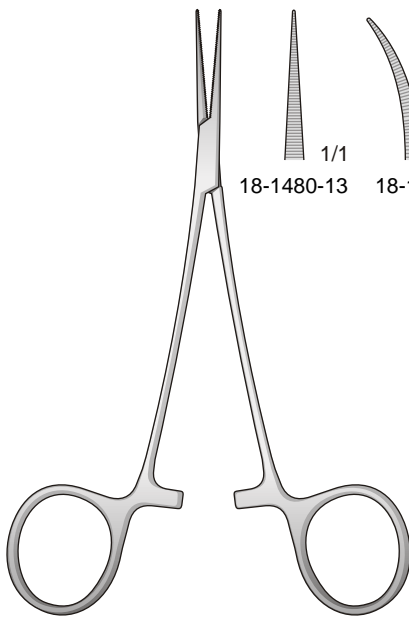

JACOBSON-MICRO
18-1480/1490
130 mm

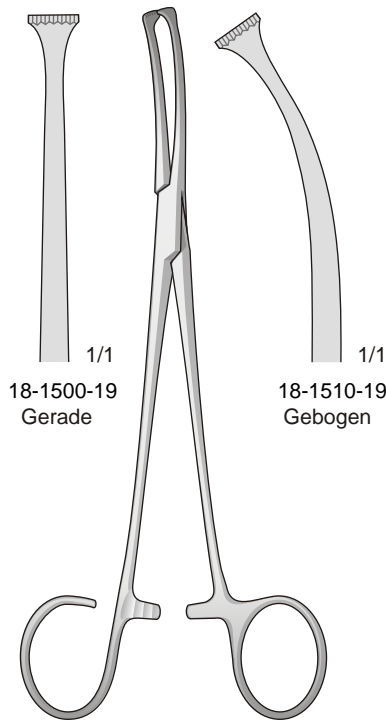
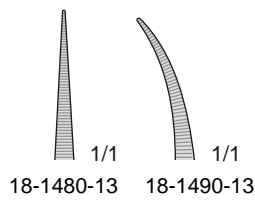

18-1500-19
Gerade

18-1510-19
Gebogen

COLVER
18-1500/1510
190 mm

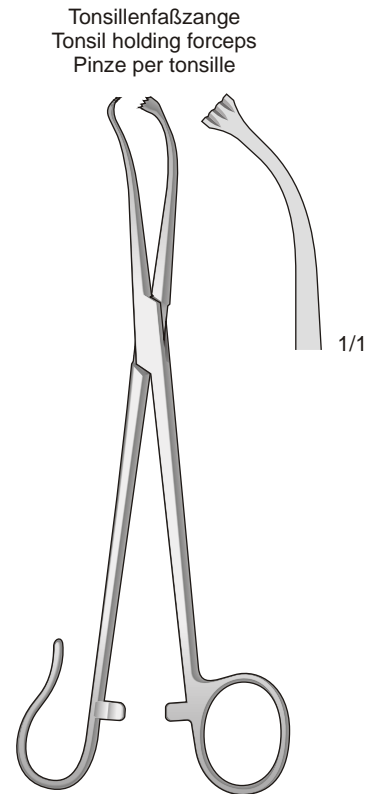

Tonsillenfaßzange
Tonsil holding forceps
Pinze per tonsille

WHITE
18-1520-18
180 mm

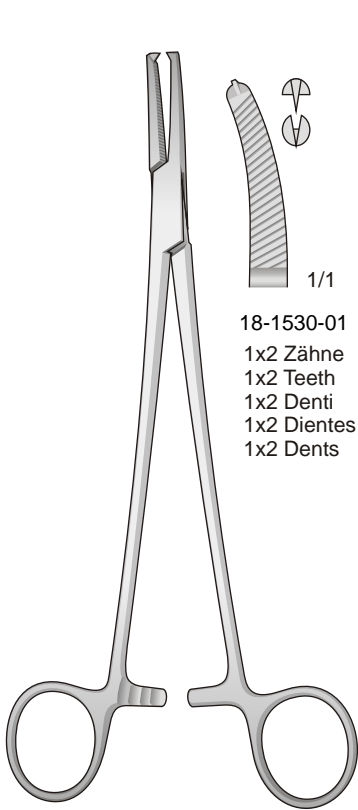

18-1530-01
1x2 Zähne
1x2 Teeth
1x2 Denti
1x2 Dientes
1x2 Dents

18-1530-02
1x2 Zähne
1x2 Teeth
1x2 Denti
1x2 Dientes
1x2 Dents

FAURE
18-1530
200 mm

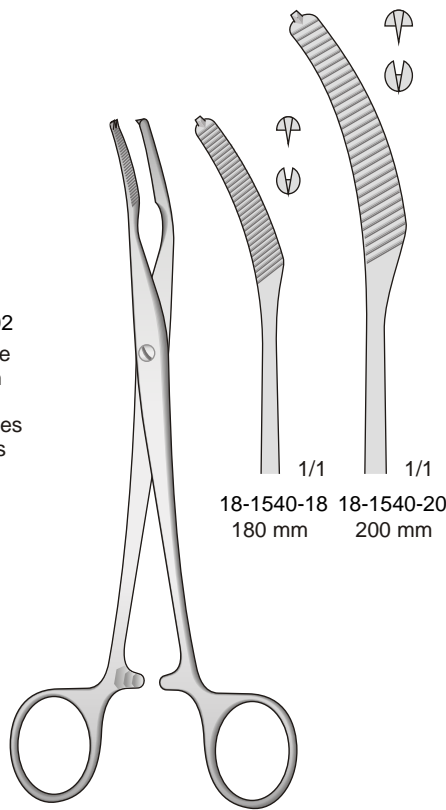

18-1540-18 18-1540-20
180 mm 200 mm

MIKULICZ
18-1540

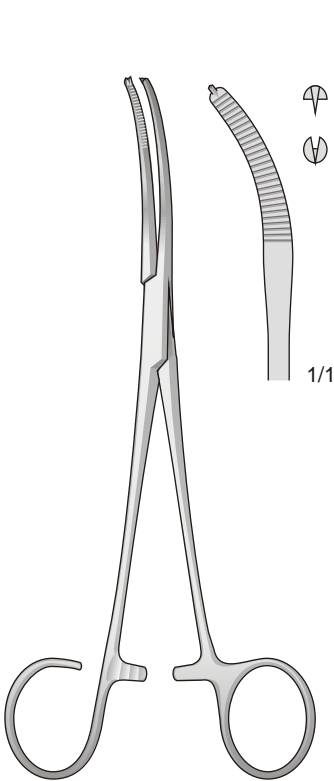

MIKULICZ
18-1550-18
185 mm

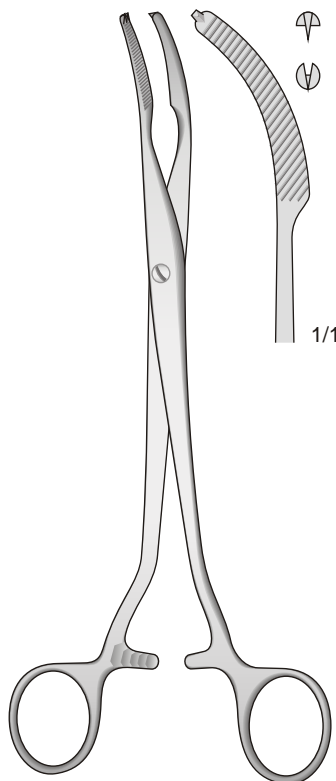

MIKULICZ
18-1560-20
200 mm

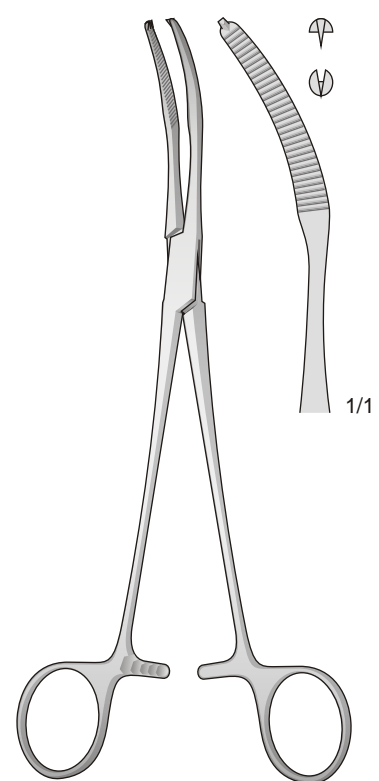

MIKULICZ
18-1570-20
200 mm

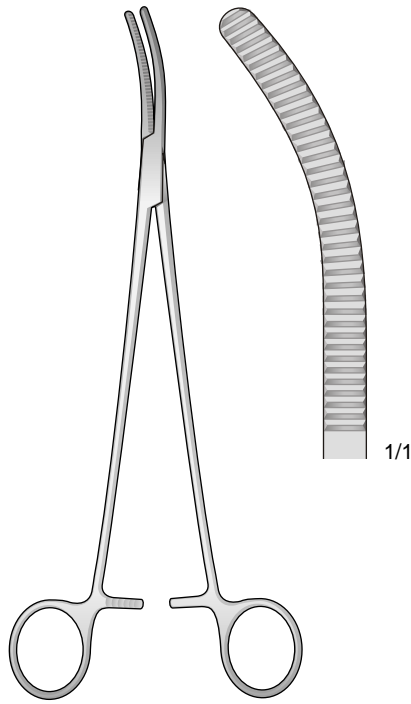

WERTHEIM
18-1580-25
250 mm

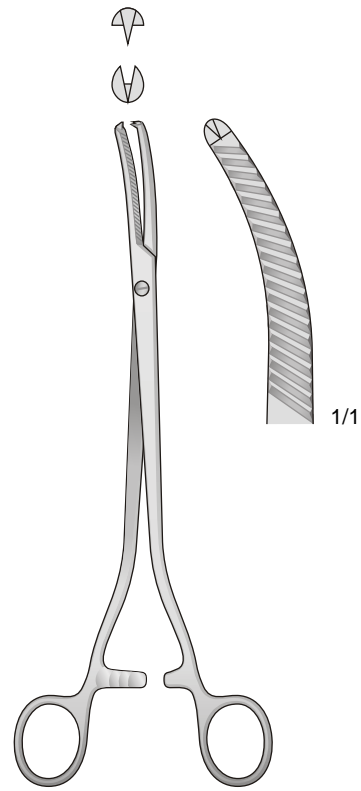

WERTHEIM
18-1590-23
230 mm

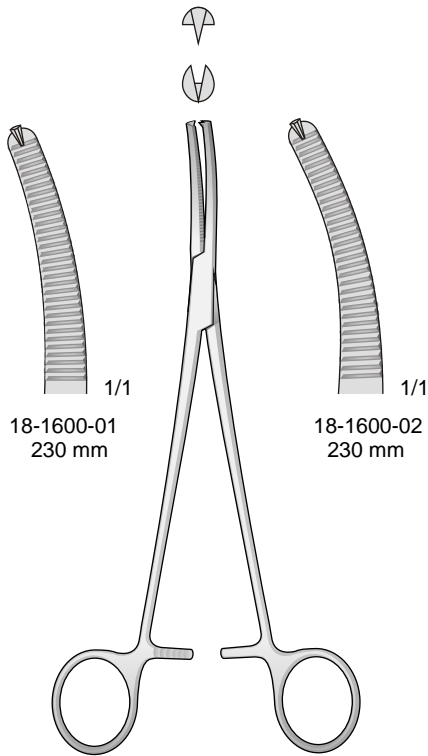

WERTHEIM
18-1600
230 mm

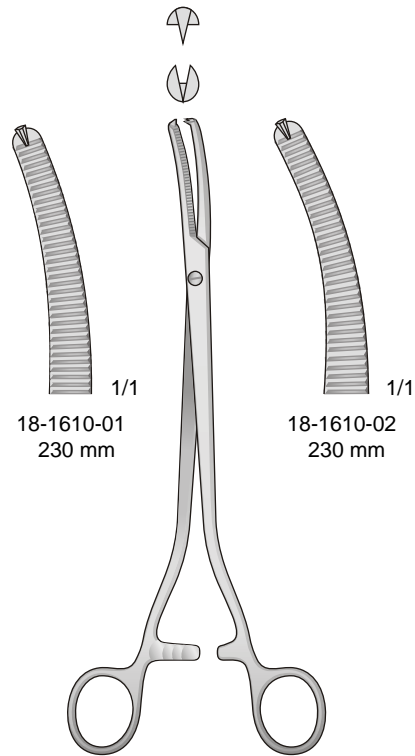

WERTHEIM
18-1610
230 mm

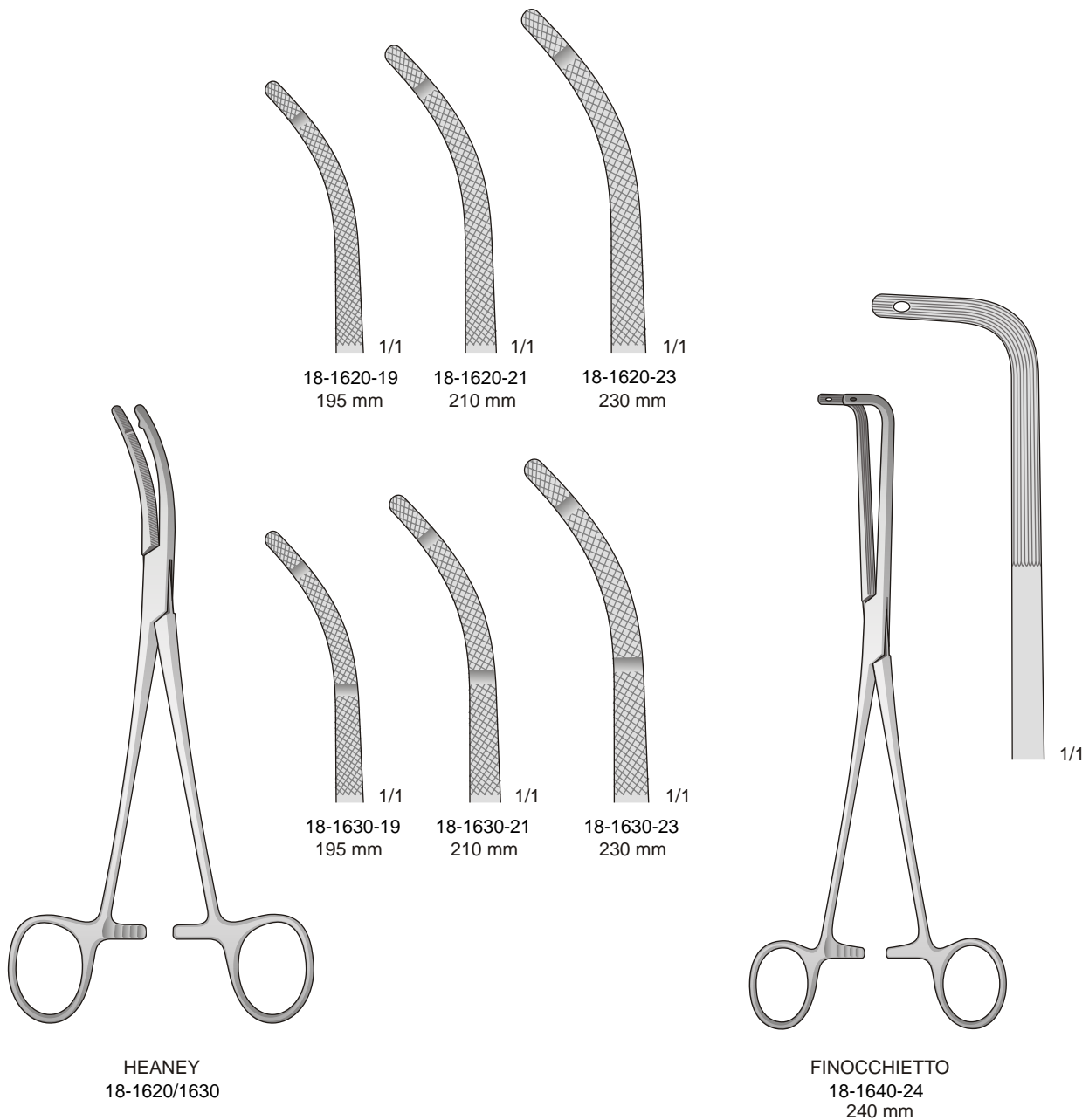

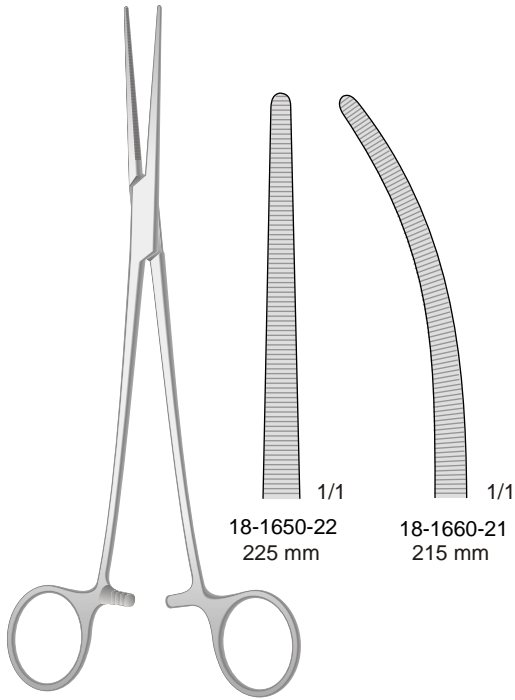

18-1650-22
225 mm

18-1660-21
215 mm

ROBERTS
18-1650/1660

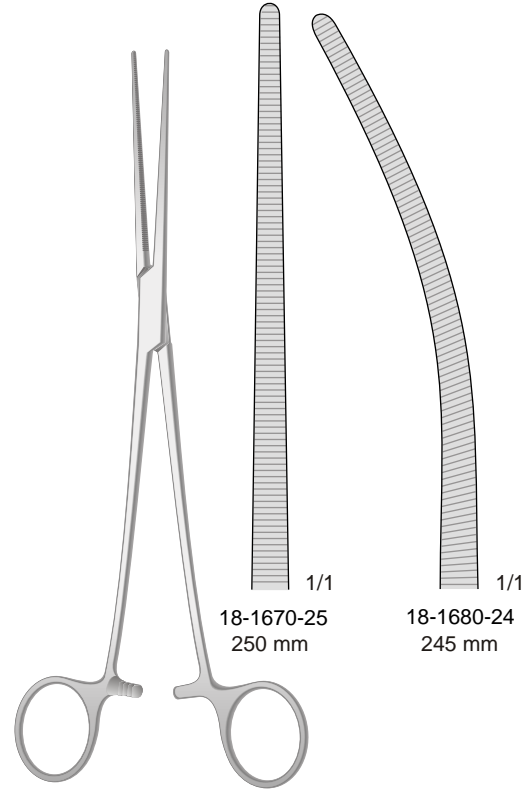

18-1670-25
250 mm

18-1680-24
245 mm

SAROT
18-1670/1680

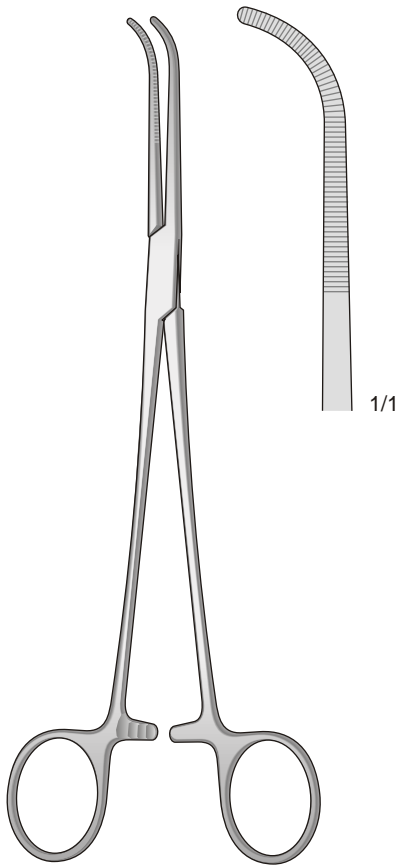

MIXTER
18-1690-22
225 mm

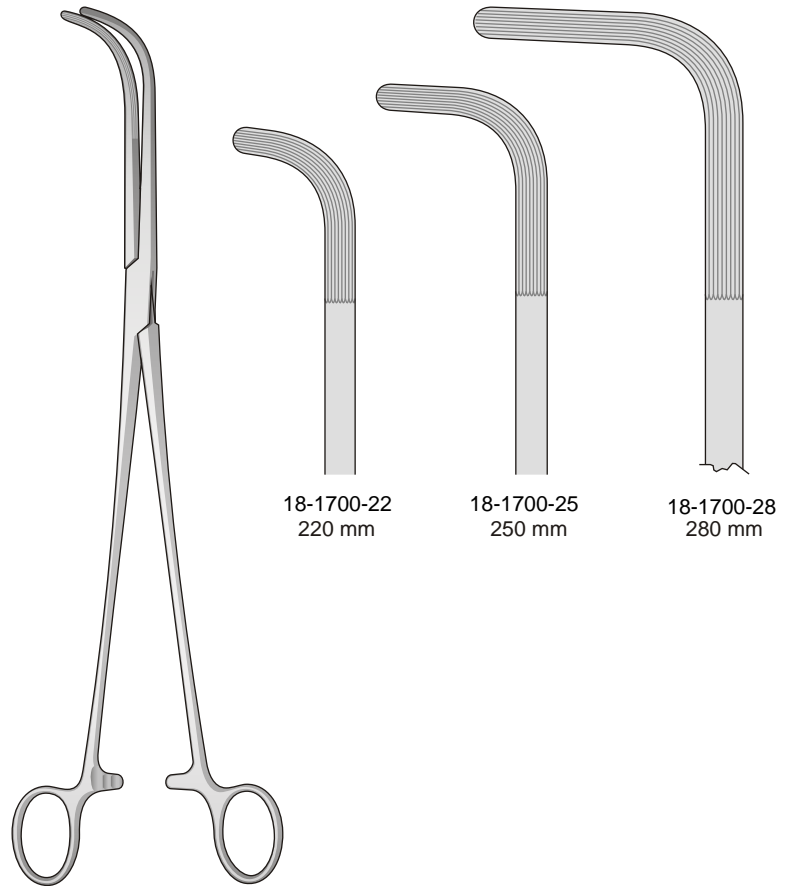

MIXTER
18-1700

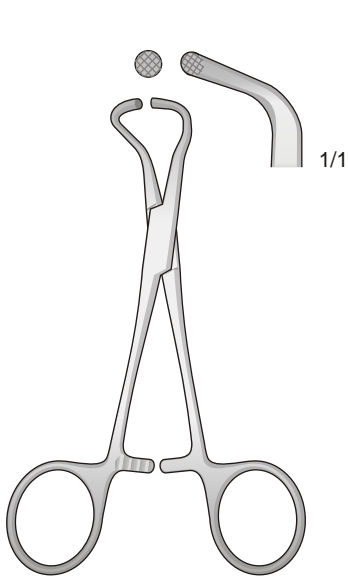

18-1710-10
100 mm

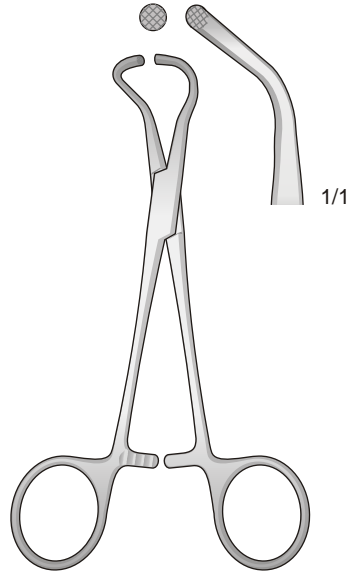

18-1710-12
125 mm

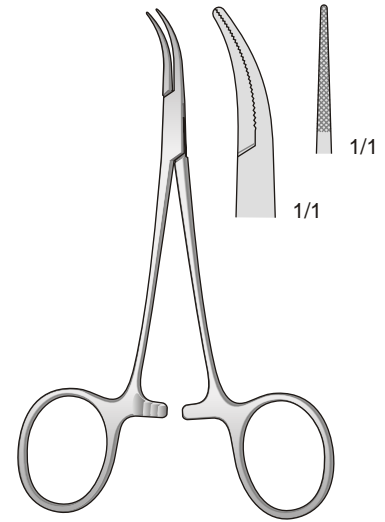

DANDY-MOSQUITO
18-1720-12
120 mm

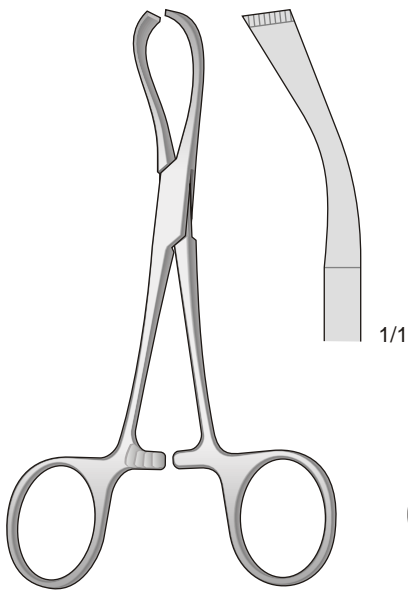

LORNA
18-1730-13
130 mm

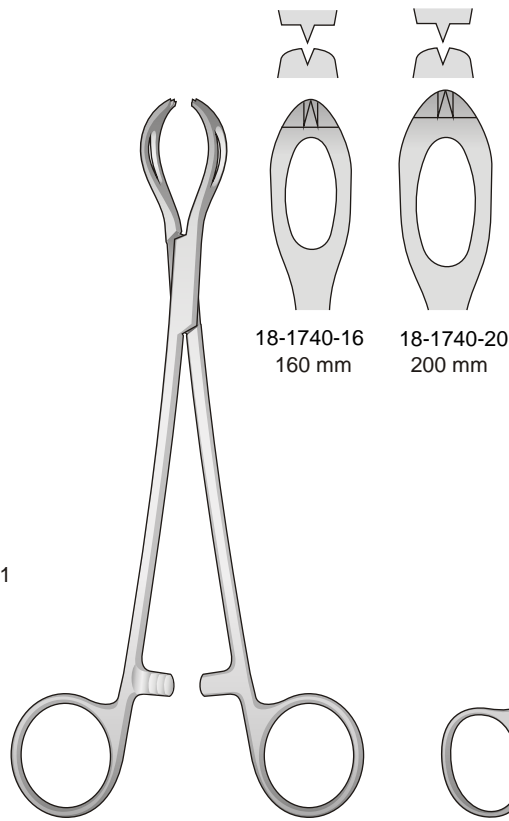

LANE
18-1740

18-1740-16
160 mm

18-1740-20
200 mm

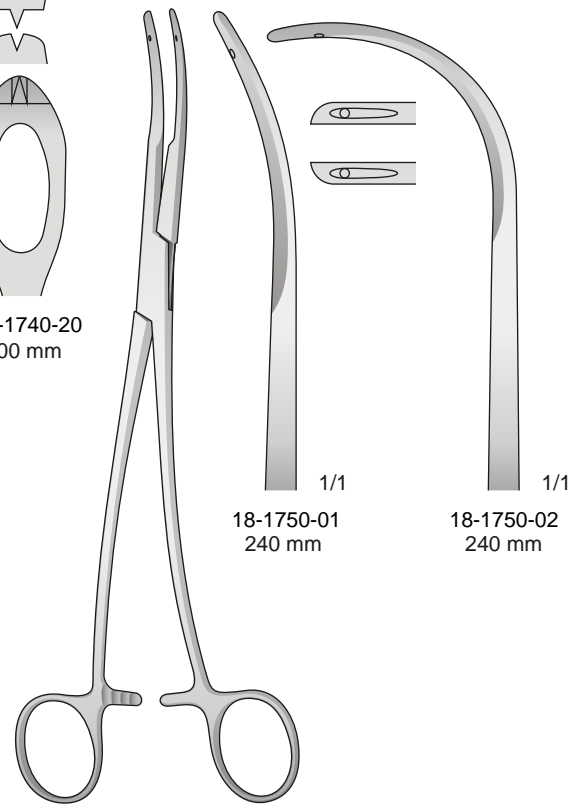

SEMB
18-1750
240 mm

18-1750-01
240 mm

18-1750-02
240 mm

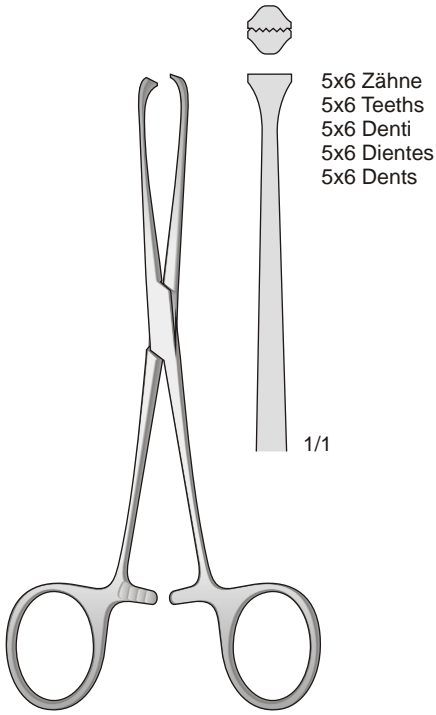

5x6 Zähne
5x6 Teeths
5x6 Denti
5x6 Dientes
5x6 Dents

1/1

BOYS-ALLIS
18-1760-15
150 mm

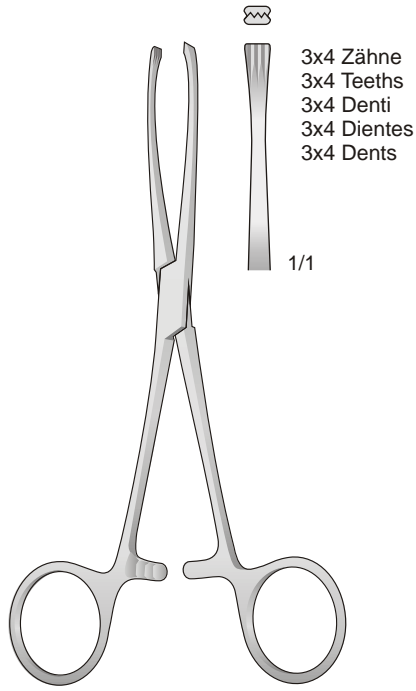

3x4 Zähne
3x4 Teeths
3x4 Denti
3x4 Dientes
3x4 Dents

1/1

JUDD-ALLIS
18-1770-15
155 mm

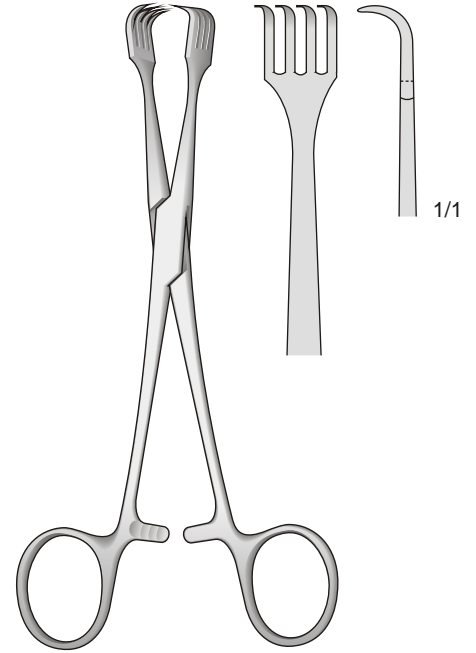

1/1

BRAUN
18-1780-15
155 mm

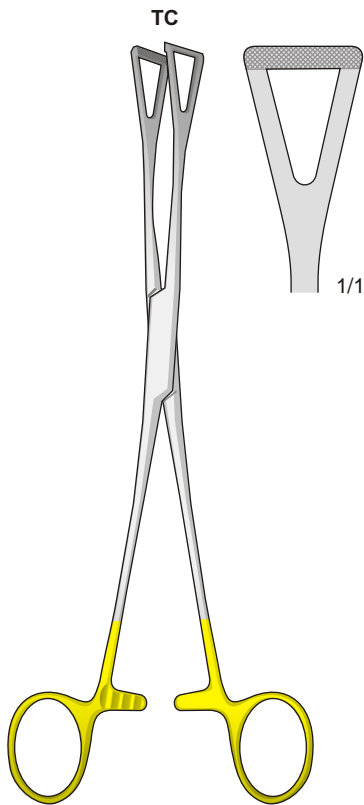

TC

1/1

DUVAL
18-1790-20
200 mm

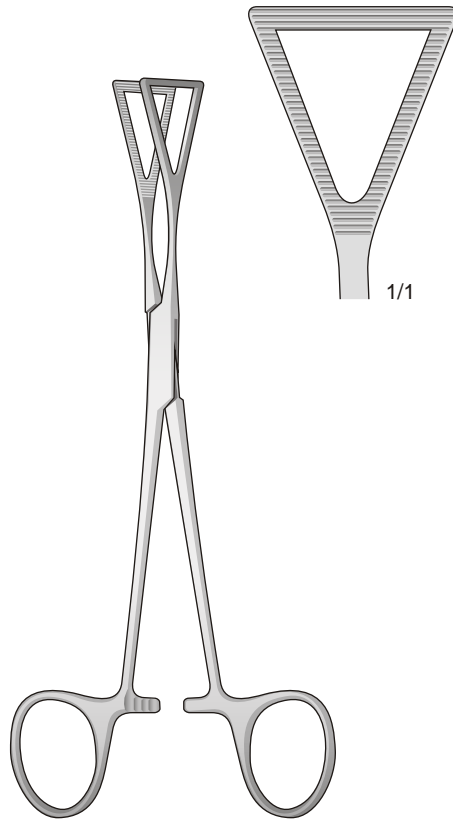

1/1

LOVELACE
18-1800-20
200 mm

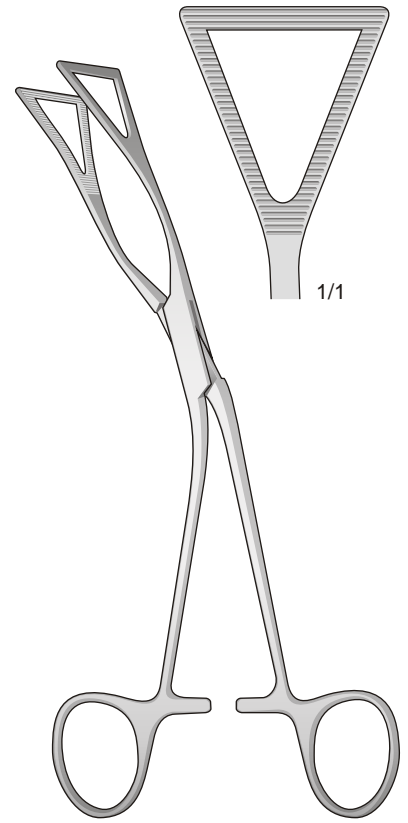

1/1

LOVELACE
18-1810-20
200 mm



PEET
18-1820-12
120 mm

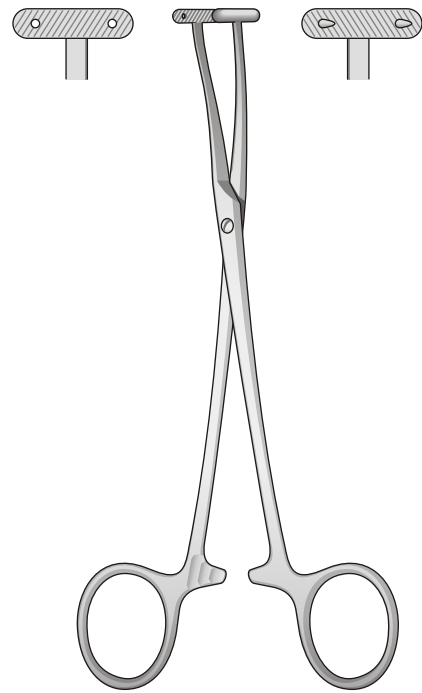

DE MARTEL
18-18230-18
180 mm



MIXTER
18-1840-22
220 mm

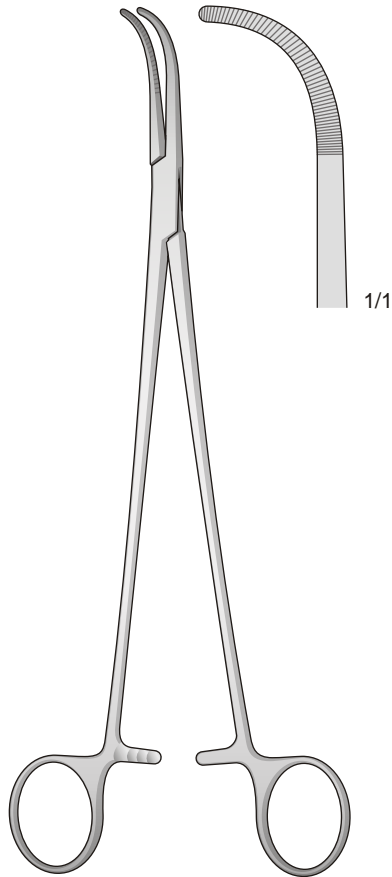

MIXTER
18-1850-23
230 mm

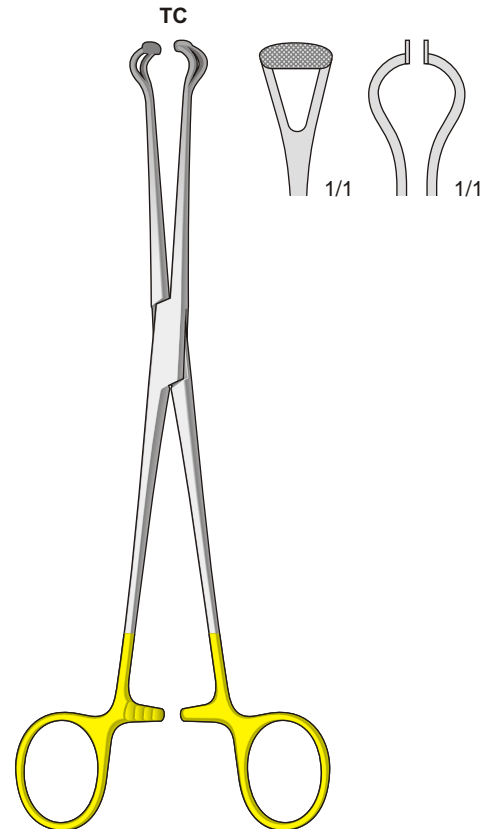

BABCOCK
18-1860-21
210 mm

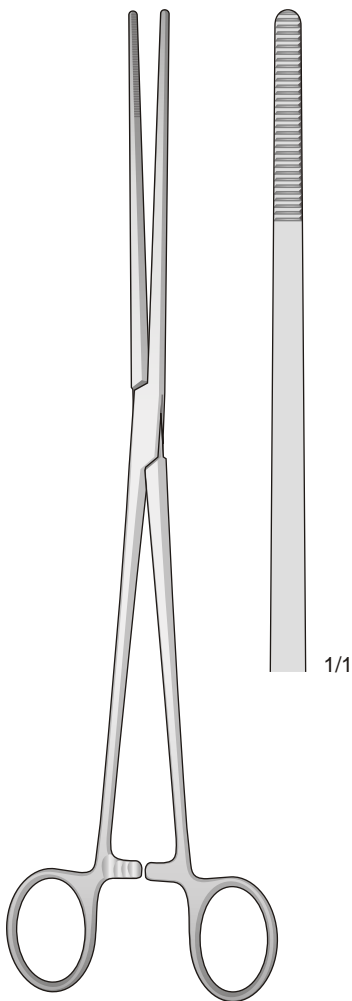

BOZEMANN
18-1870-26
260 mm

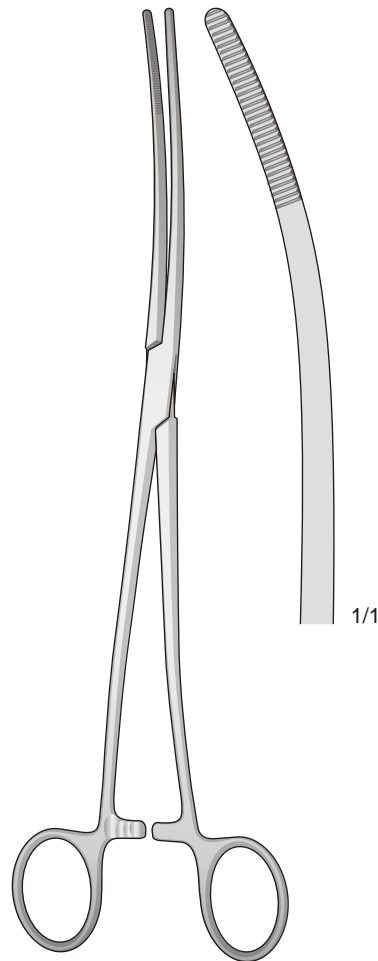

BOZEMANN
18-1880-26
260 mm

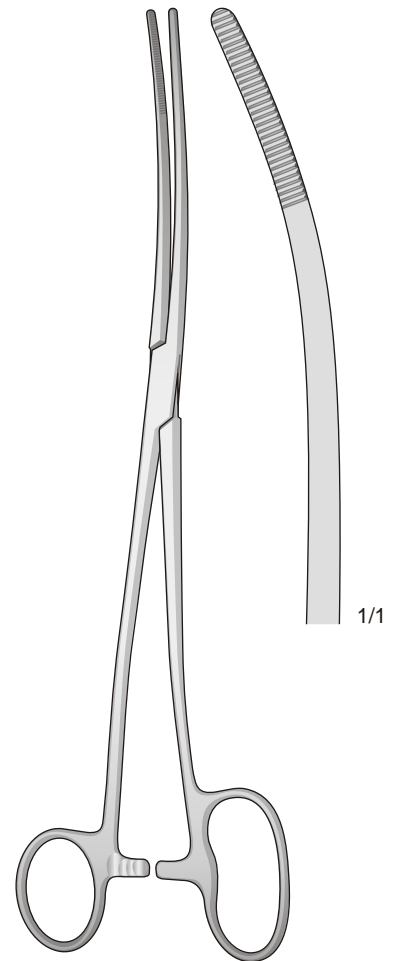

BOZEMANN-DOUGLAS
18-1890-26
260 mm



De BAKEY

Atraumatiche

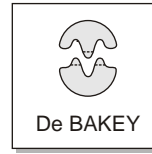

De BAKEY

Atraumatiche

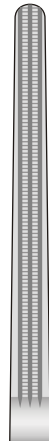

18-1900-01
250 mm

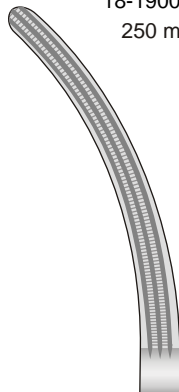

18-1900-02
245 mm

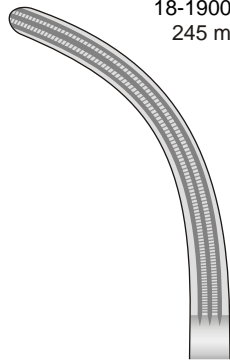

18-1900-03
240 mm

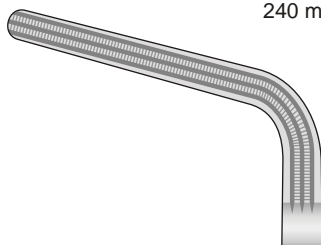

18-1900-04
230 mm

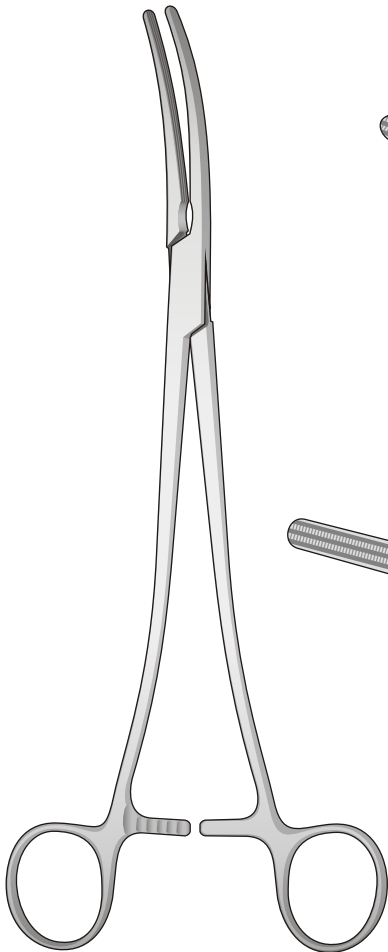

18-1900
WERTHEIM

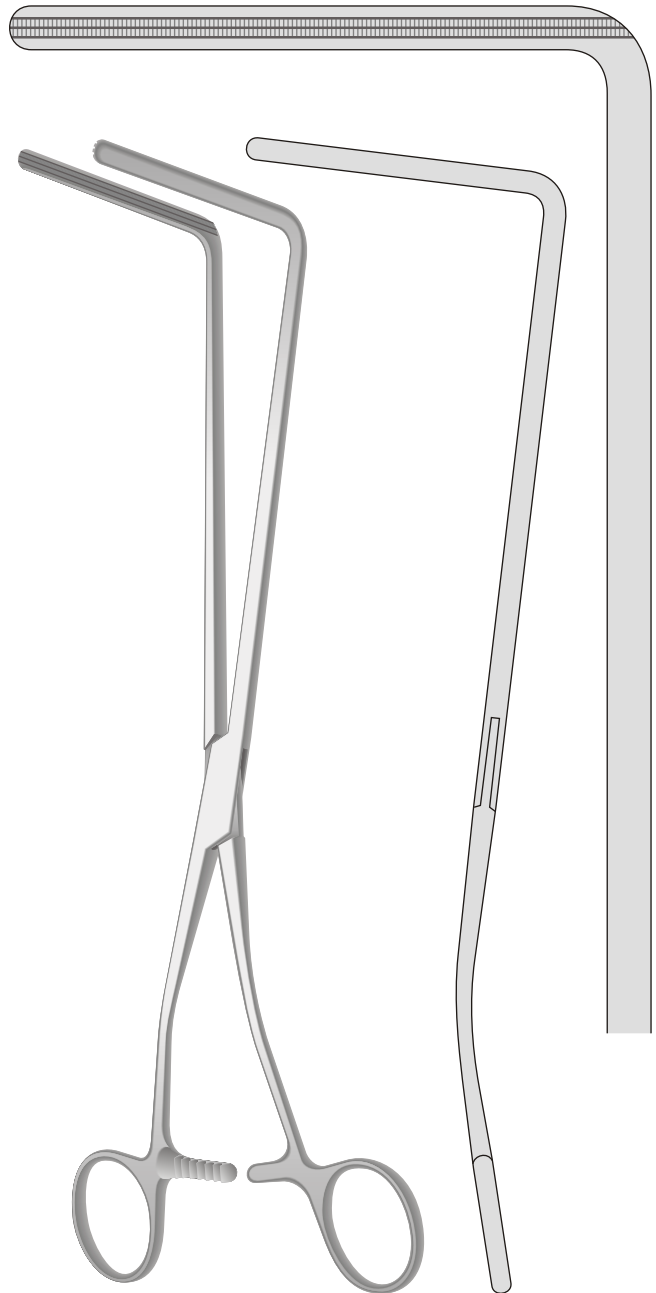

RESANO
18-1910
280 mm

1/1

Weich und elastisch
With soft and
elastic blades

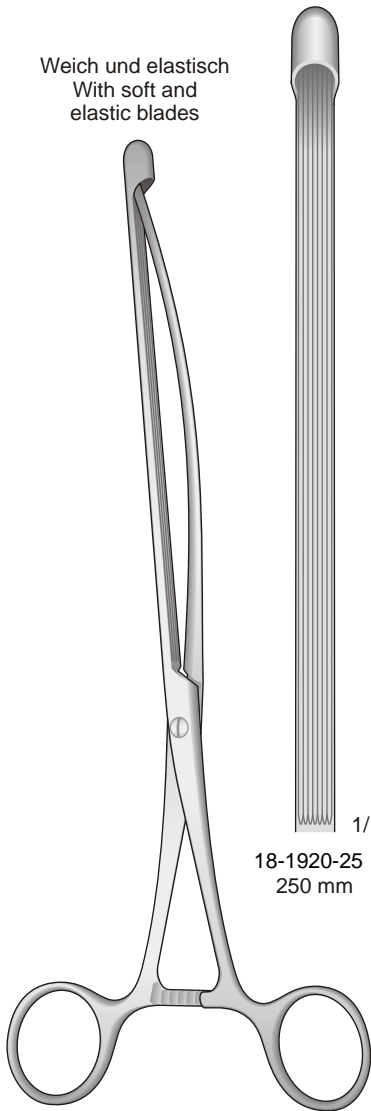

NUSSBAUM
18-1920/1930
250 mm

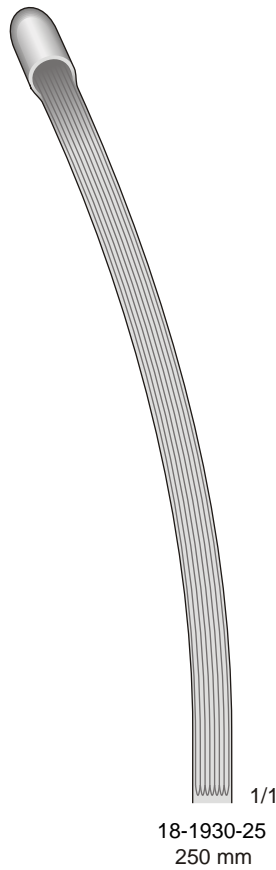
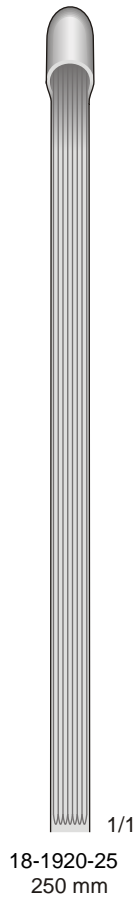

Atrauma

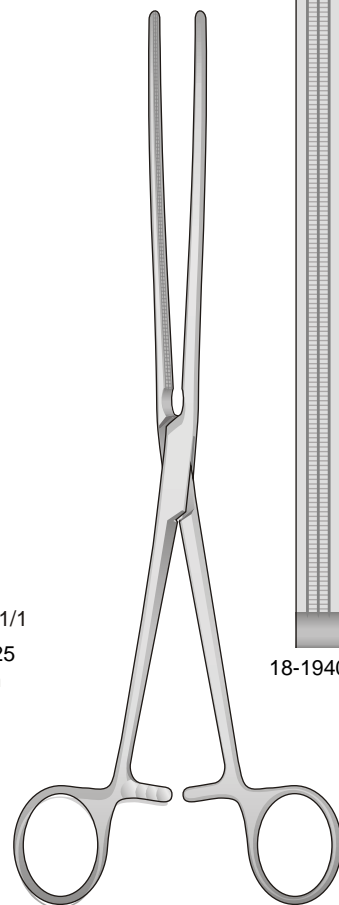

DOYEN
18-1940/1950
230 mm

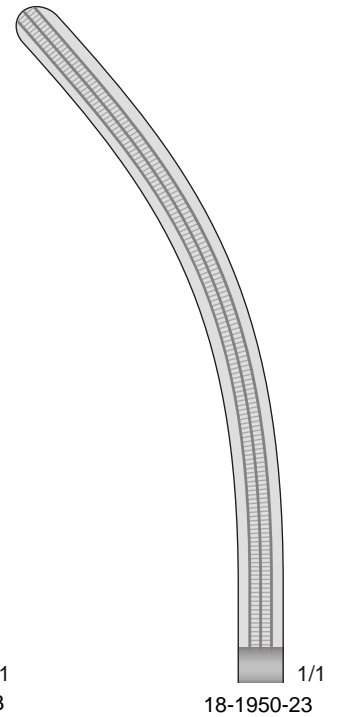
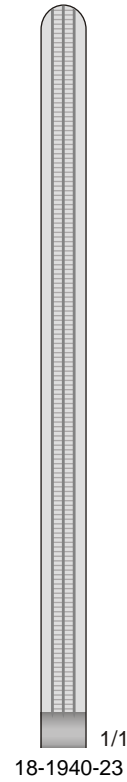

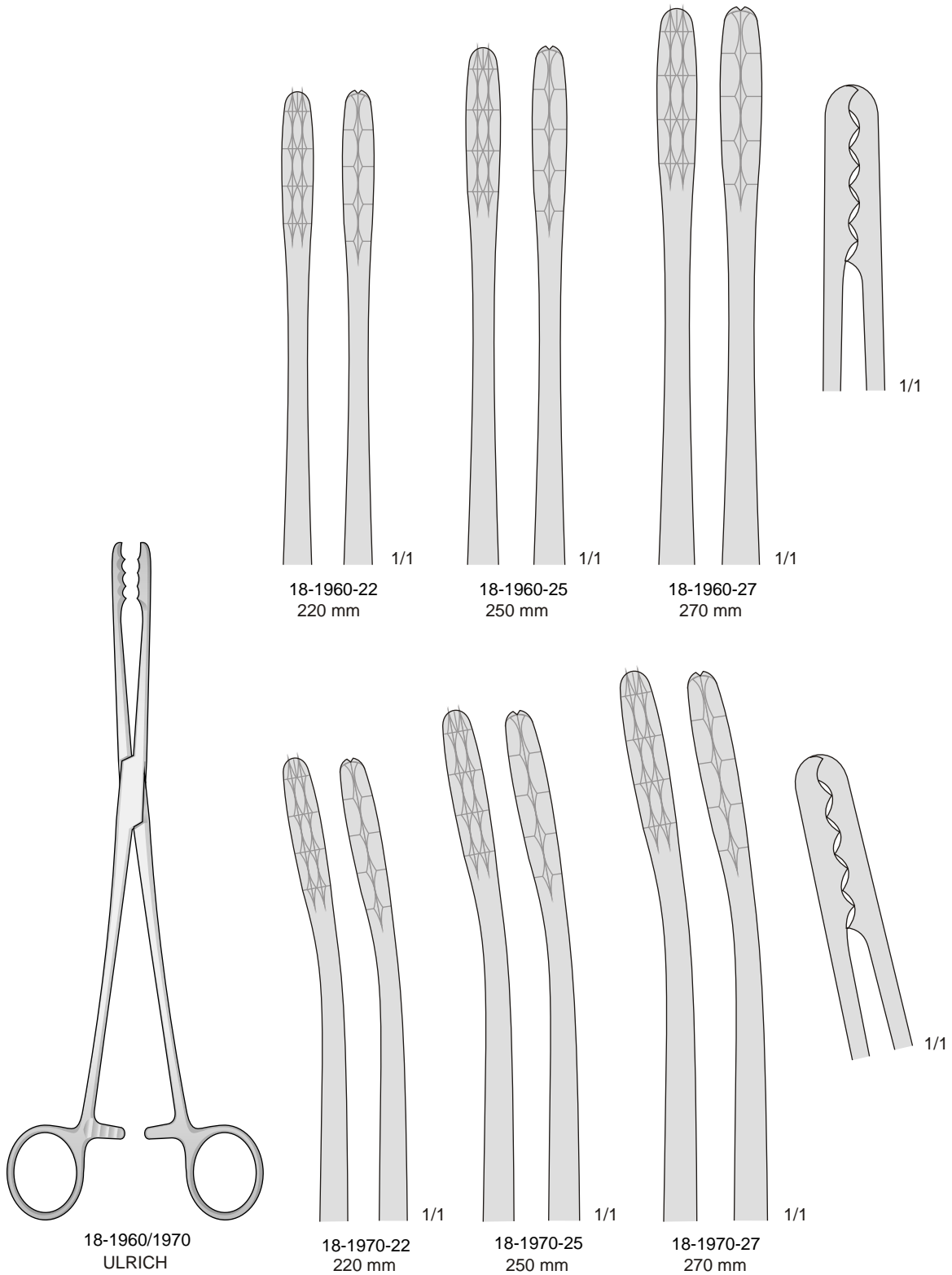

Titan - Titanium - Titanio - Titane

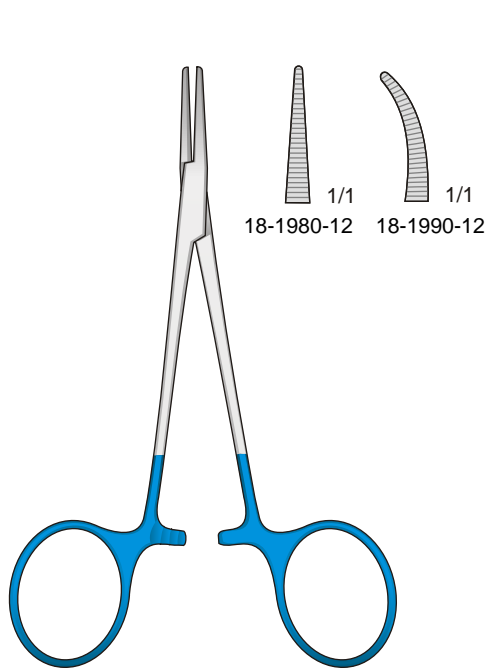

HALSTED-MOSQUITO
18-1980/1990
120 mm

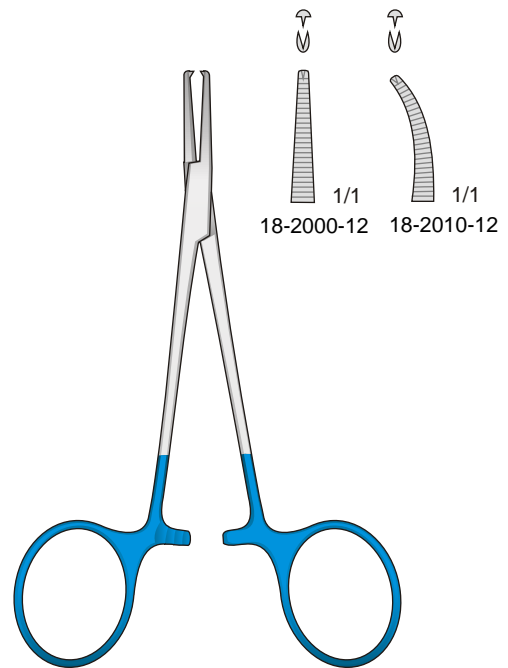

HALSTED-MOSQUITO
18-2000/2010
120 mm

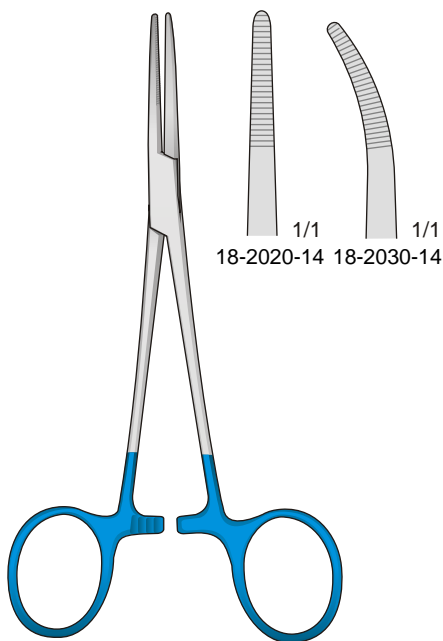

KELLY
18-2020/2030
140 mm

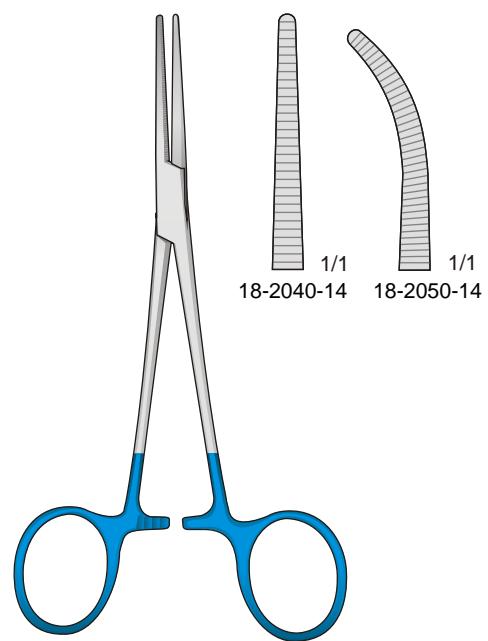

CRILE
18-2040/2050
140 mm

18-2060
Krampfaderbesteck komplett
Varicose Vein Probe Set complete
Set completo sonda per varici
Juego para varices completo
Trousse à varices complète

Metall-Sondenspitzen
Probe tip, metal
Punta per sonda
in metallo
Punta metálica
Pointe en métal

Ø 3 mm

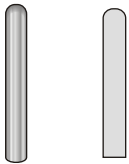

18-2080

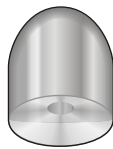

18-2070

Oliven - Olives - Olive - Oliva - Olive



18-2070-01



18-2070-02

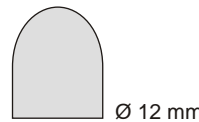

18-2070-03

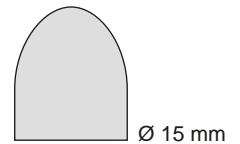

18-2070-04

Griff Allein
Handle only
Manico solo
Mango solo
Manche seule

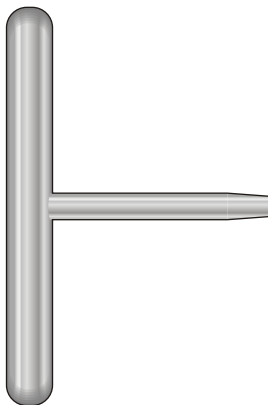

18-2090

Zugseil
Traction Cable
Cavo per trazione
Cable de tracción
Cable tracteur

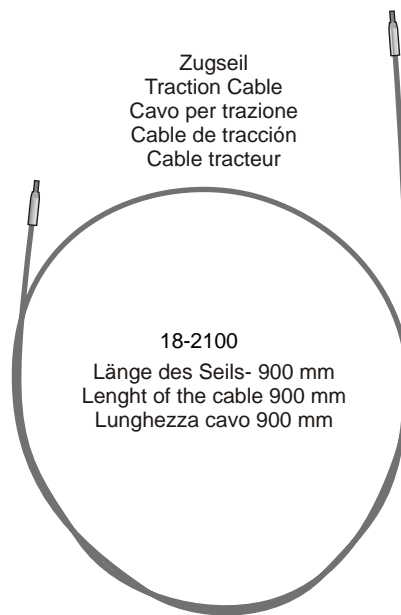

18-2100
Länge des Seils- 900 mm
Length of the cable 900 mm
Lunghezza cavo 900 mm

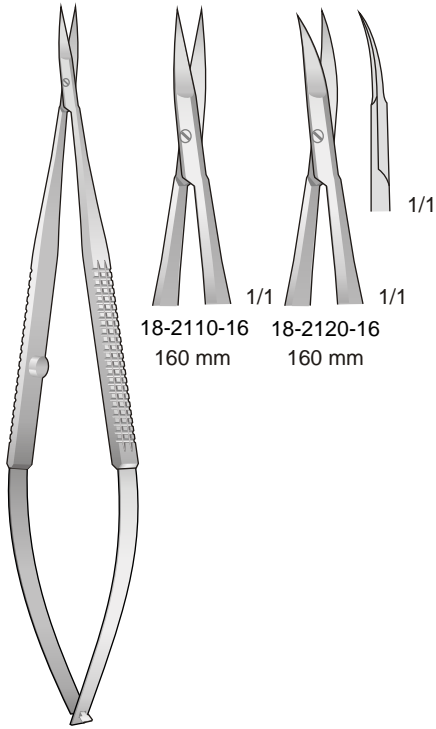

18-2110/2120
160 mm

18-2110-16
160 mm

18-2120-16
160 mm

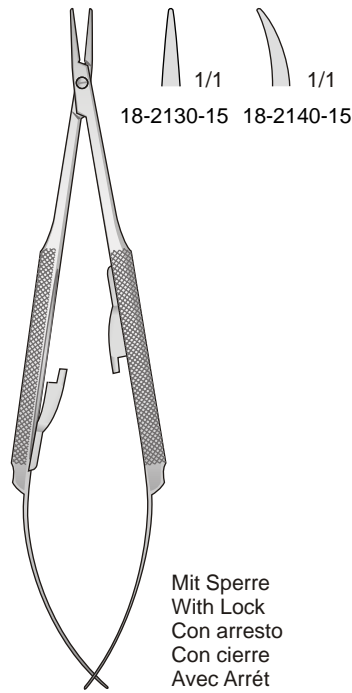

BARRAQUER
18-2130/2140
150 mm

Mit Sperre
With Lock
Con arresto
Con cierre
Avec Arrêt

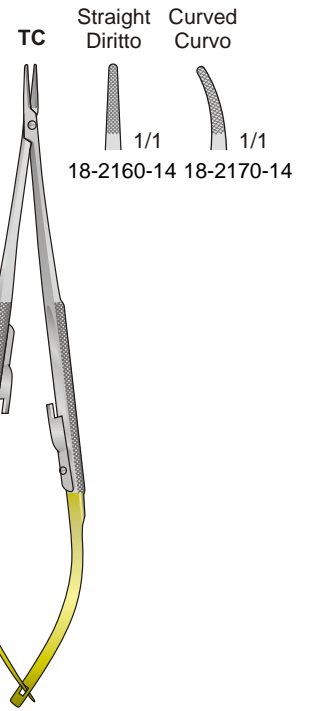

CASTROVIEJO
18-2150/2160
140 mm

Nadelhalter mit Hartmetalleinlagen - Needle Holders with tungsten-carbide inserts
Portaghi con inserti al tungsteno - Portaagujas con plaquitas de carburo de tungsteno
Porte aiguilles avec plaquettes en carbure de tungstène

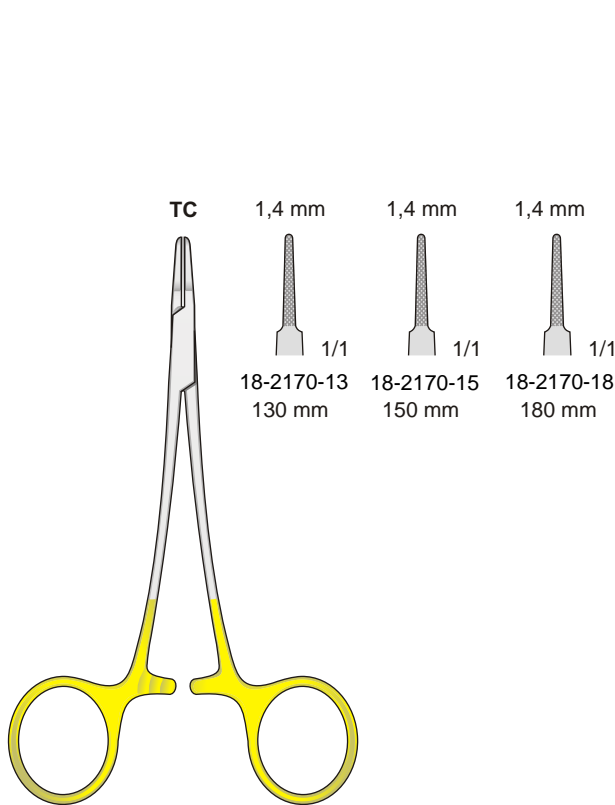

MICRO-RYDER
18-2170

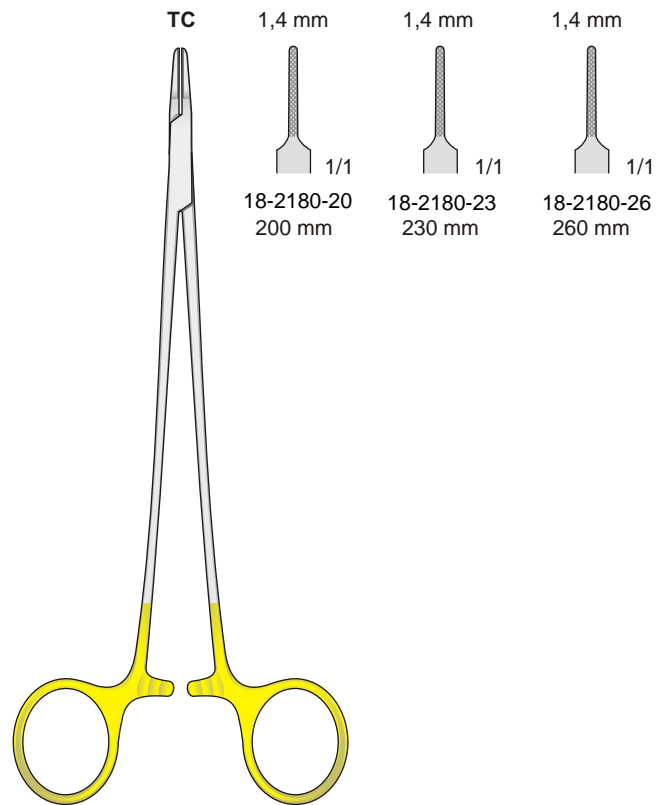

MICRO-RYDER
18-2180

Nadelhalter mit Hartmetalleinlagen - Needle Holders with tungsten-carbide inserts - Portaghi con inserti al tungsteno
Portaagujas con plaquitas de carburo de tungsteno - Porte aiguilles avec plaquettes en carbure de tungstène

Ein Ring abgewinkelt
One ring angled
Un anello angolato

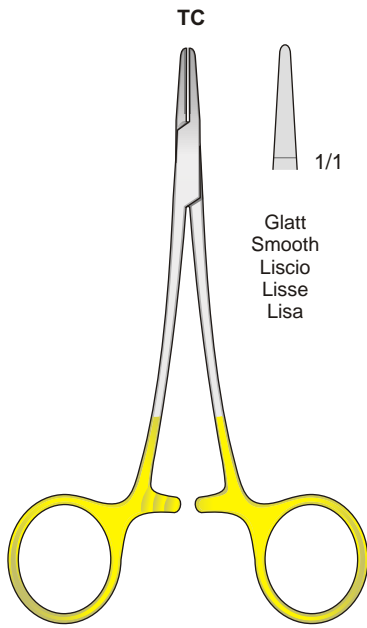

TC
HALSEY
18-2190-13
130 mm

Glatt
Smooth
Liscio
Lisse
Lisa

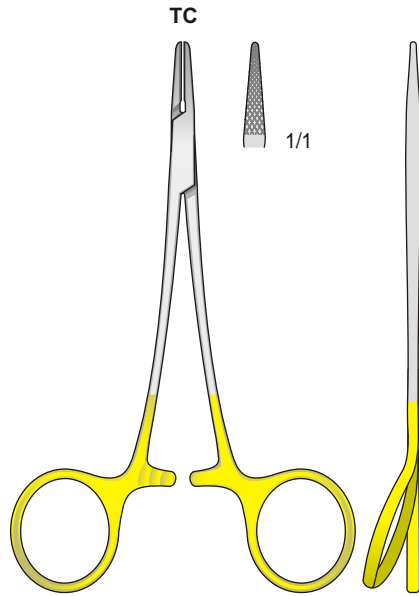

TC
18-2200-12
120 mm

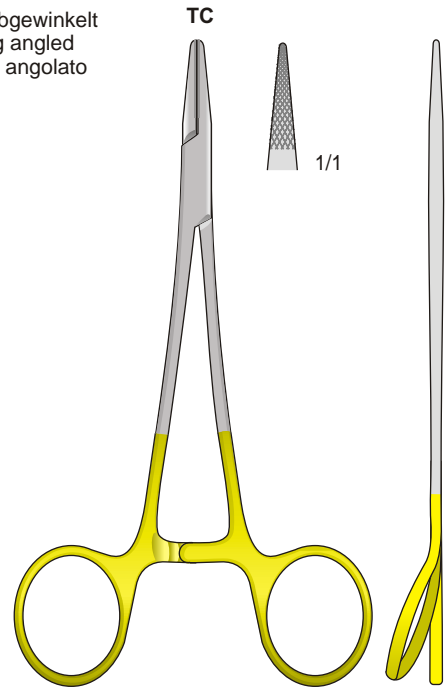

TC
CRILE-WOOD
18-2210-15
150 mm

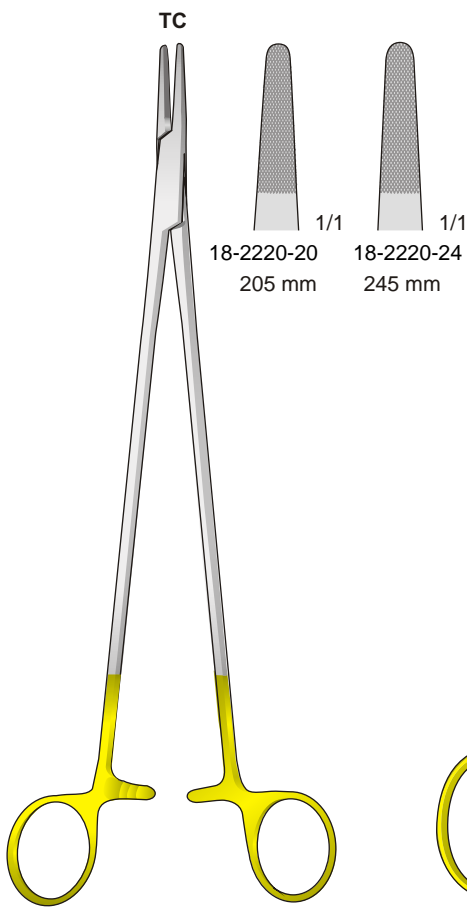

TC
HEGAR
18-2200

18-2220-20 205 mm
18-2220-24 245 mm

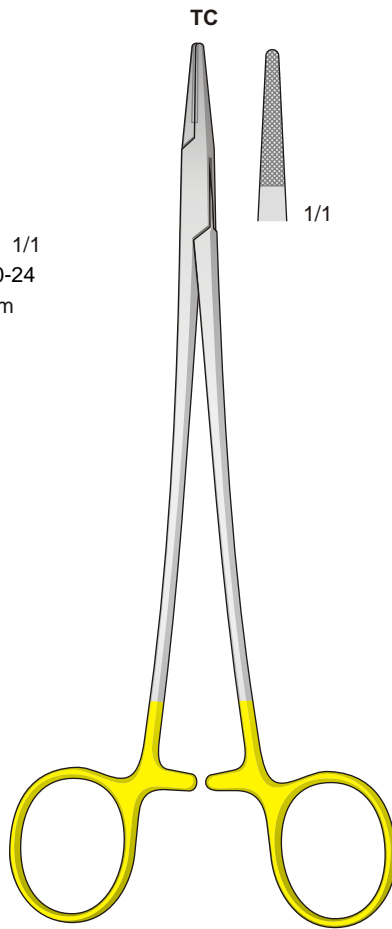

TC
DE BAKEY
18-2230-37
370 mm

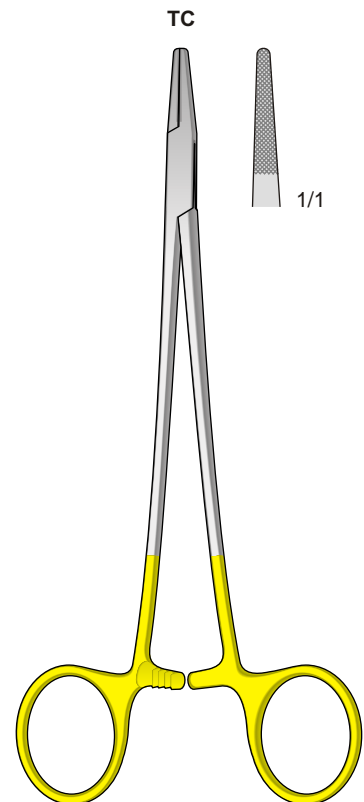

TC
DeBAKEY
18-2240-20
200 mm

Für Linkshänder - Left Handed
Per mancini - Pour gauche - Para zurdos

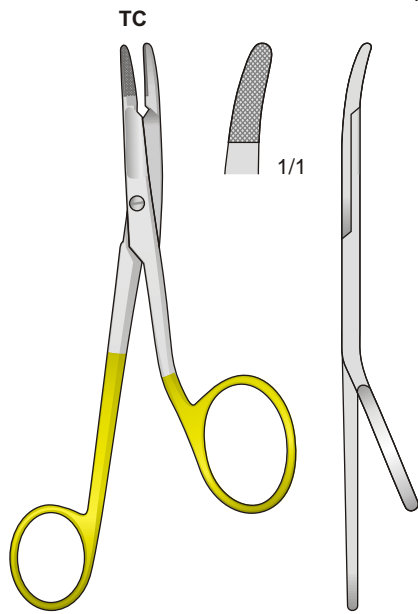

GILLIES
18-2250-16
160 mm

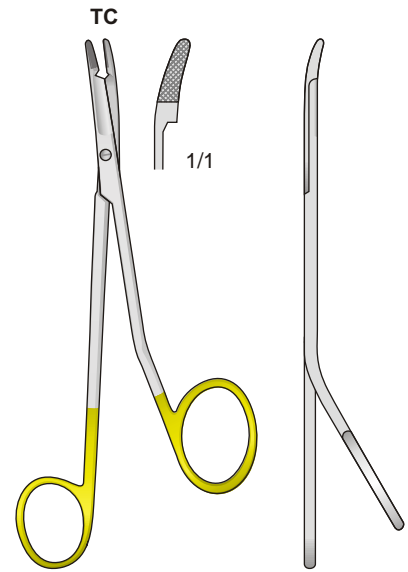

MINI-GILLIES
18-2250-14
145 mm

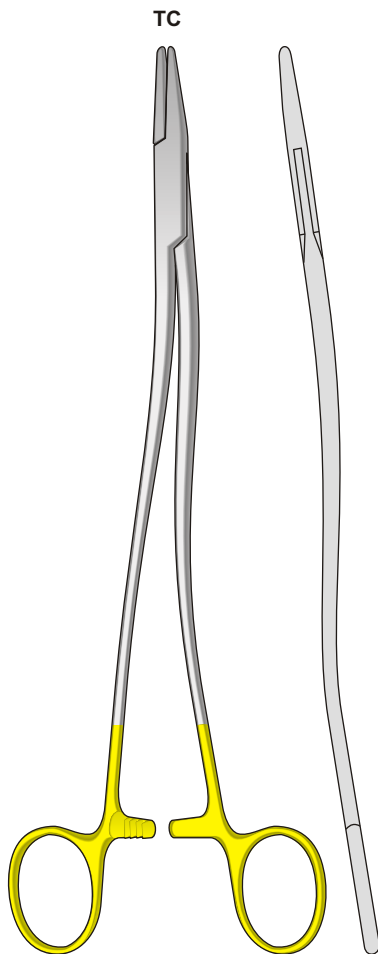

BOZEMANN
18-2260

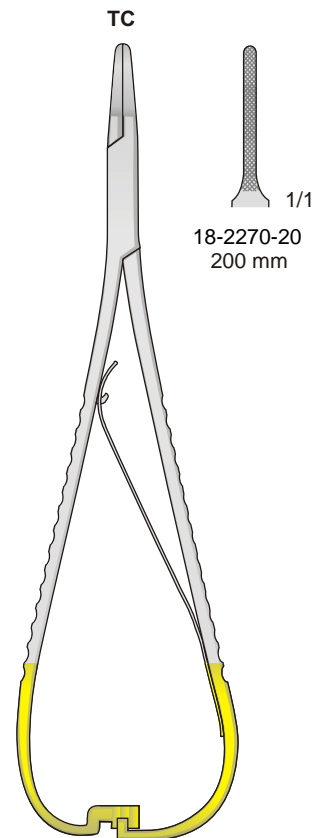
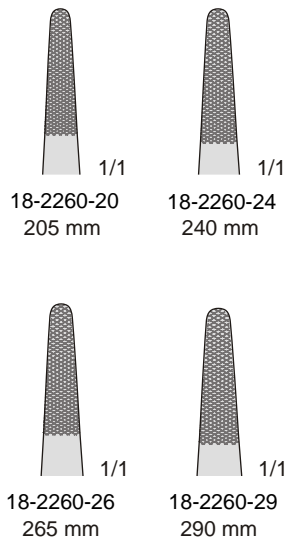

LICHTENBERG
18-2270
175 mm

Kräftiges Modell
Heavy pattern
Modello robusto
Modèle robuste

TC

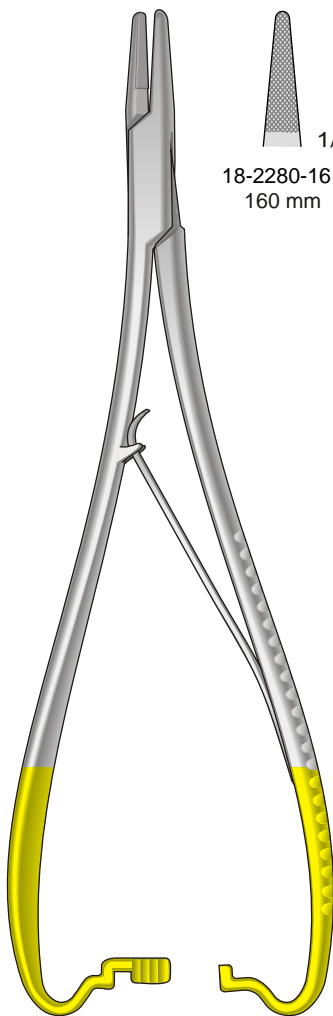

MATHIEU
18-2280

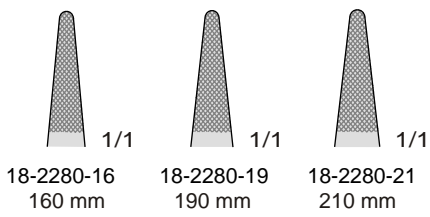

Atraumatiche - Atraumatic
Atraumatiche - Atraumáticas
Atraumatique

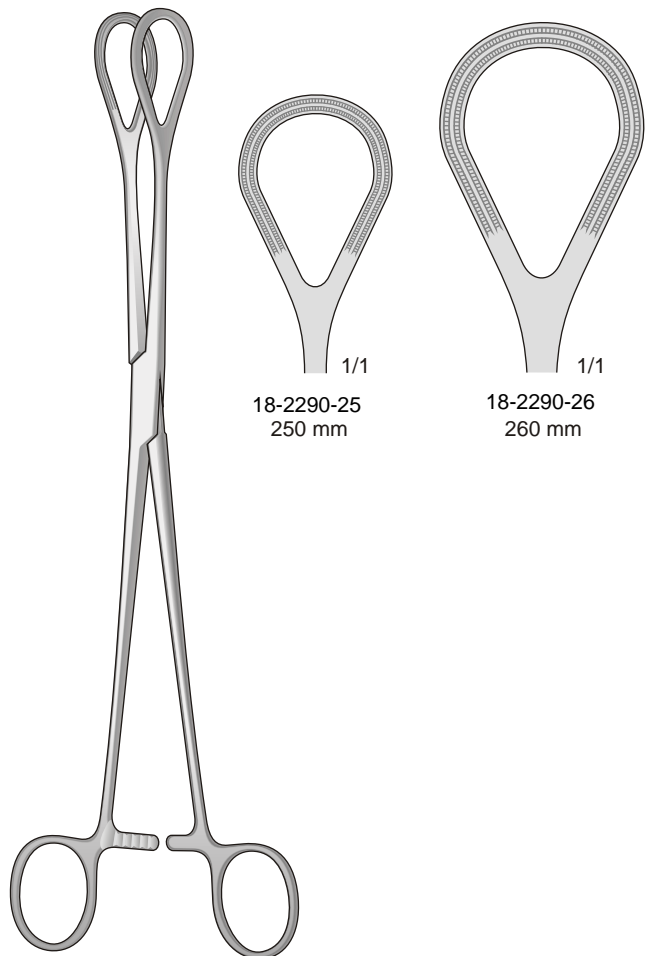

18-2290

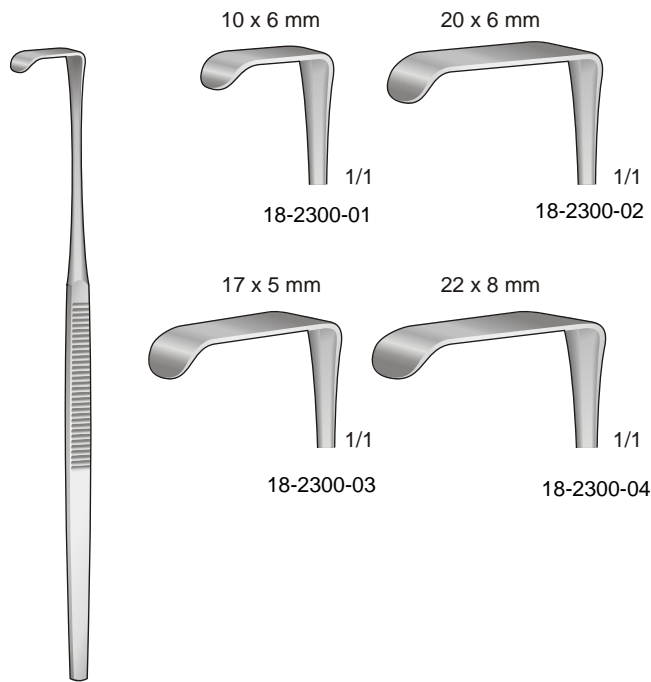

MINI-LANGENBECK
18-2300
160 mm

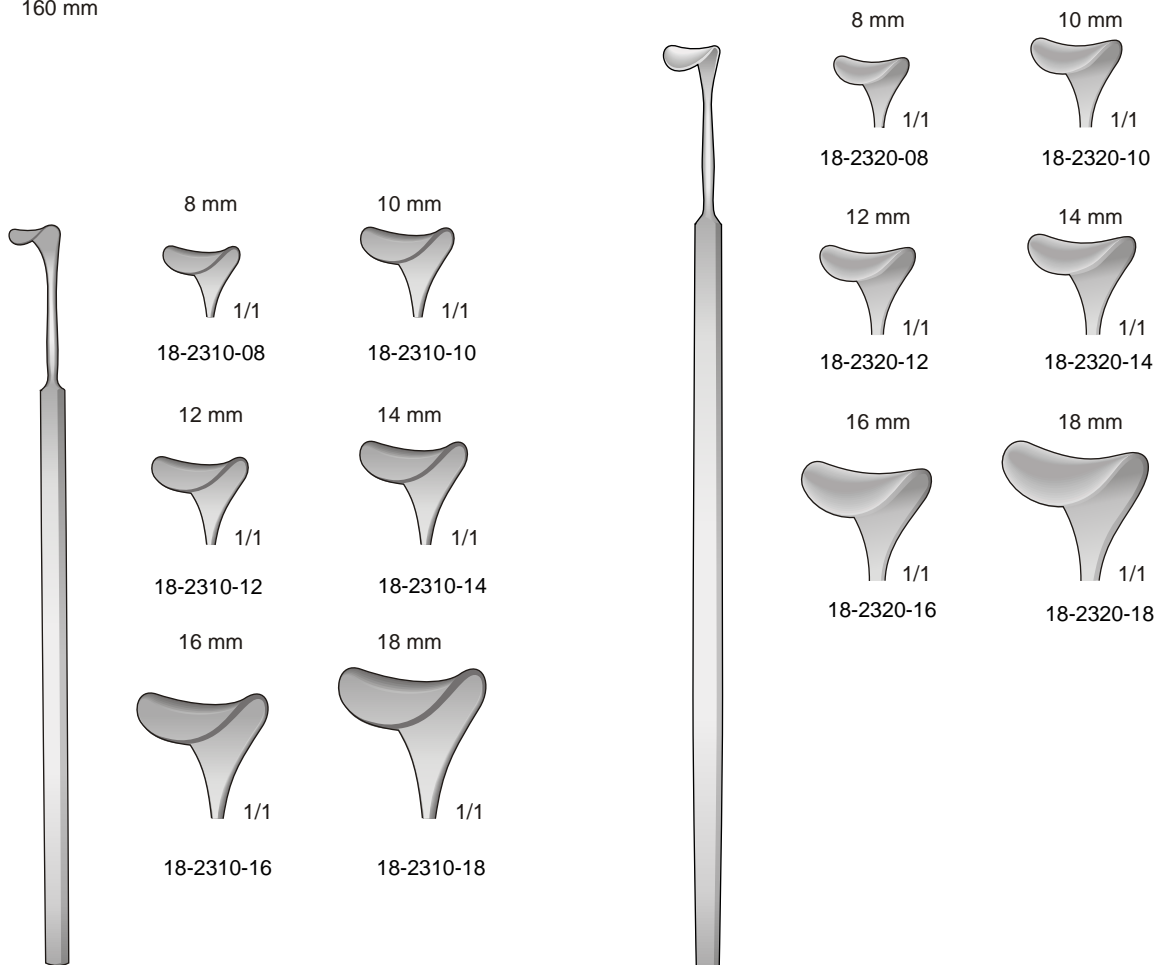

CUSHING
18-2310
200 mm

CUSHING
18-2320
240 mm

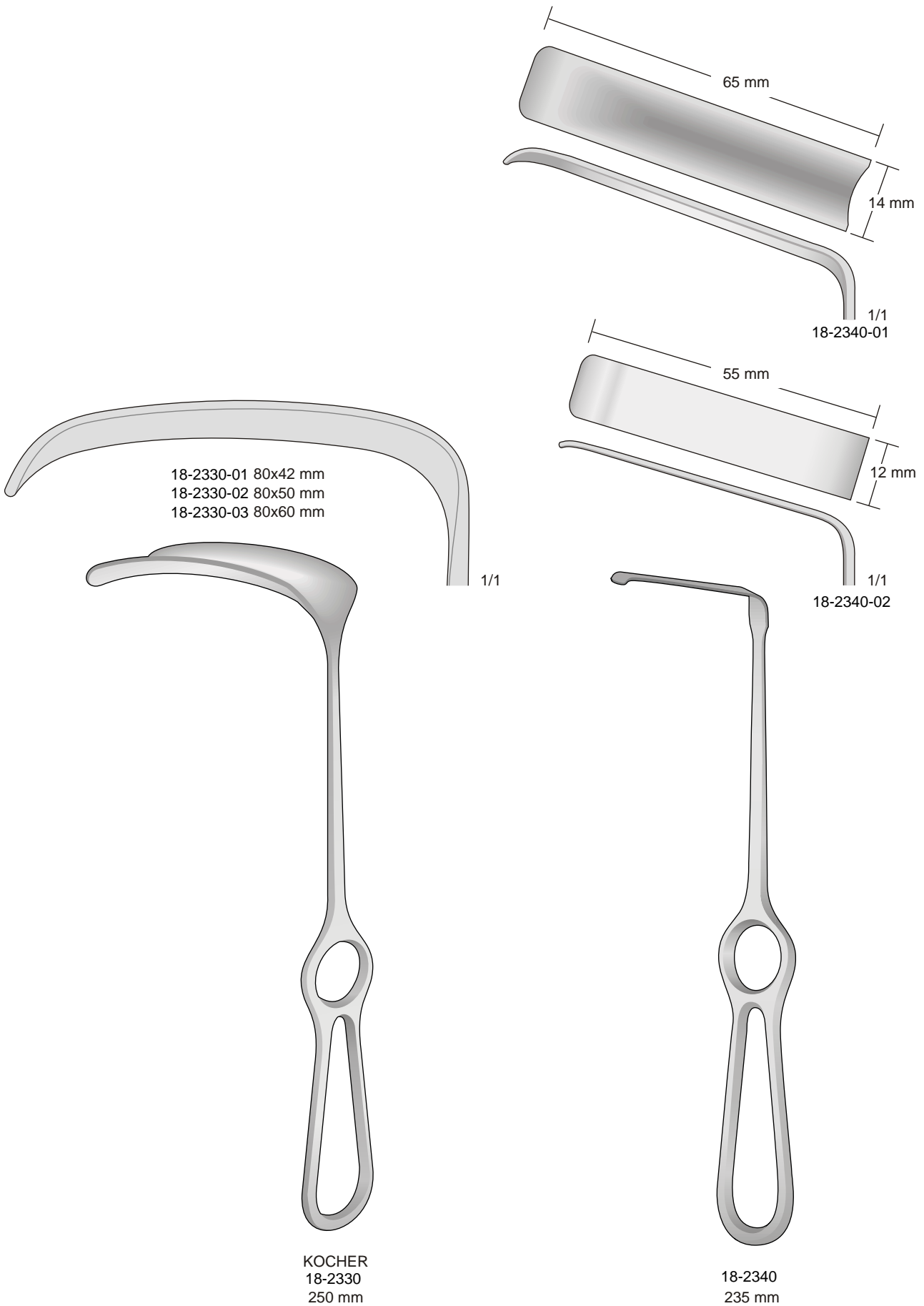

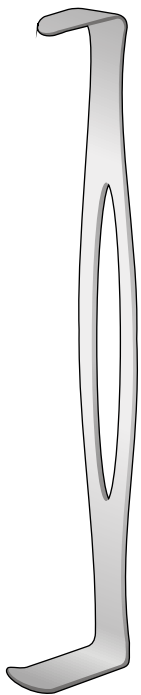
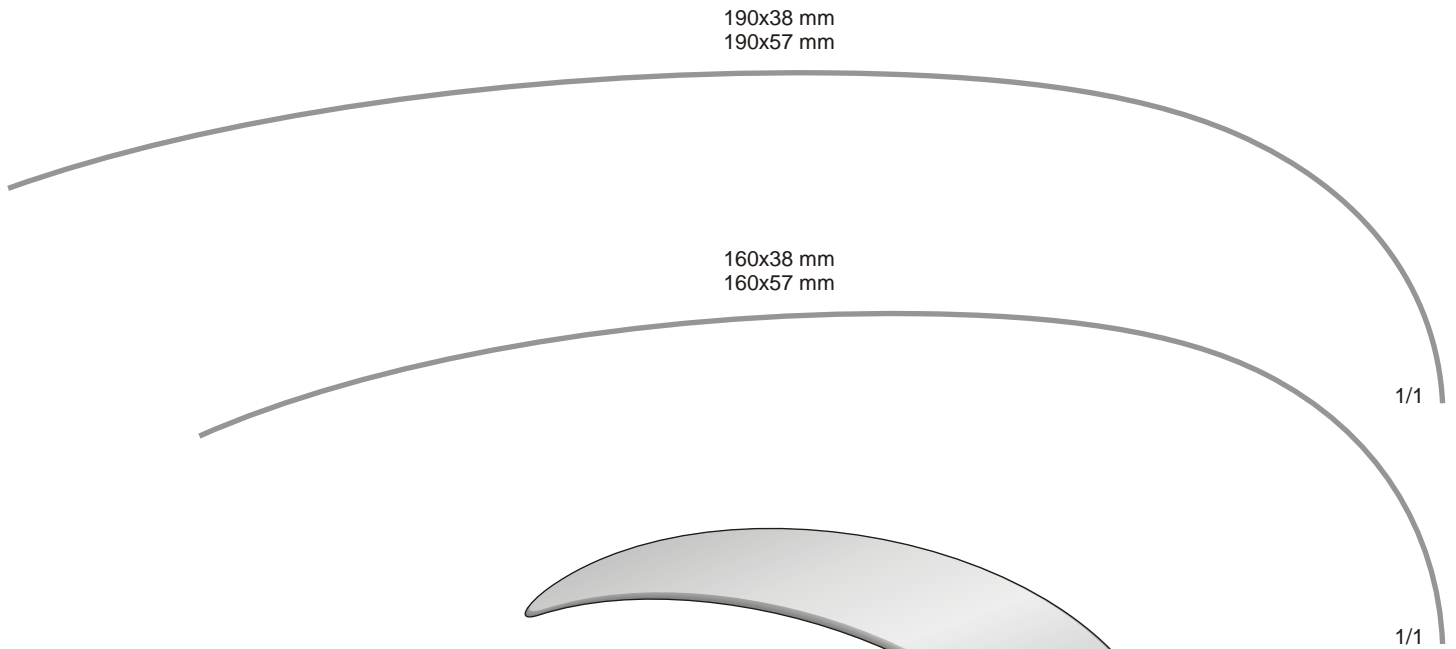

18-2350-01
21 x 24 mm
40 x 15 mm

PARKER-LANGENBECK
18-2350
210 mm

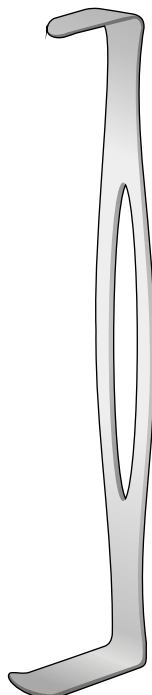

18-2350-02
25 x 24 mm
45 x 15 mm

PARKER-LANGENBECK
18-2350
210 mm

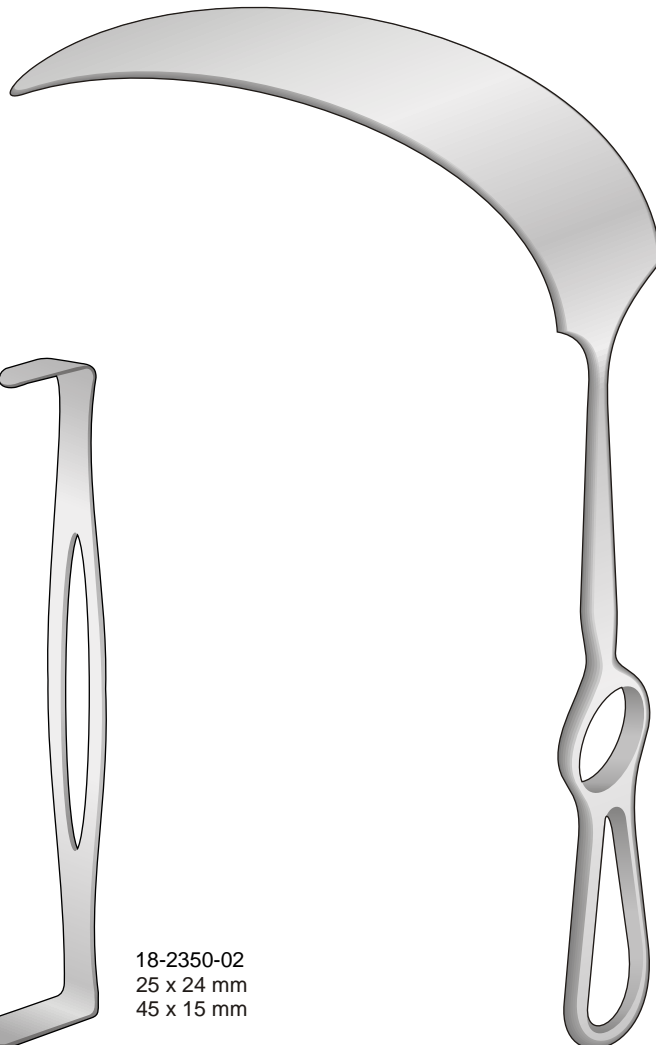

18-2360-01 160x38 mm
18-2360-02 160x57 mm
18-2360-03 190x38 mm
18-2360-04 190x57 mm

KELLY
18-2360
270 mm

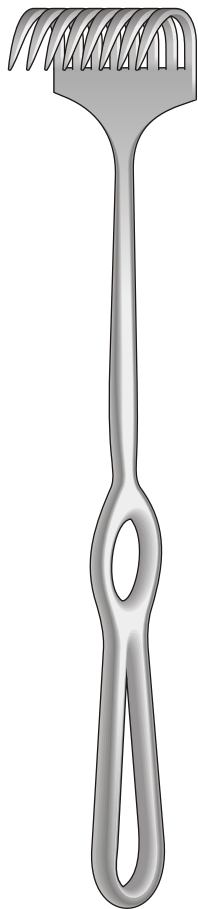
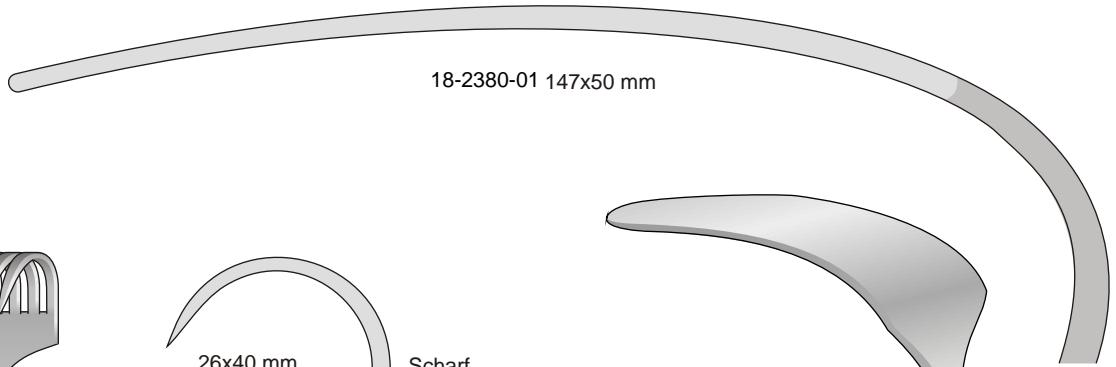
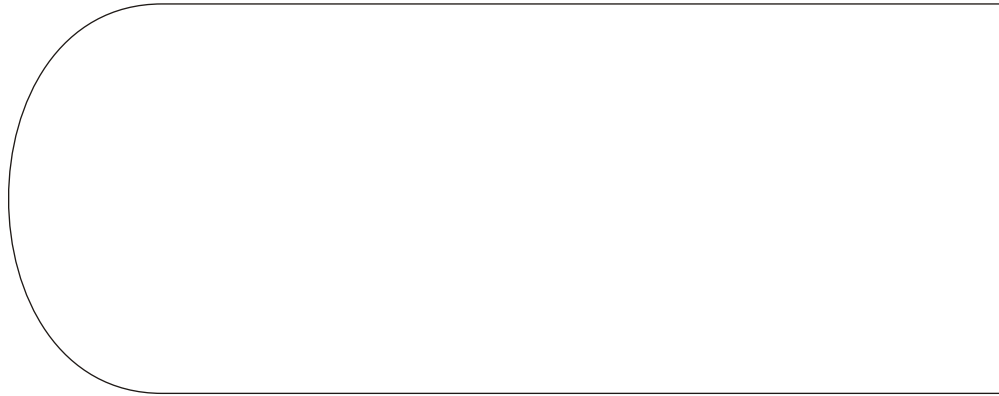

KÖRTE
18-2370
240 mm

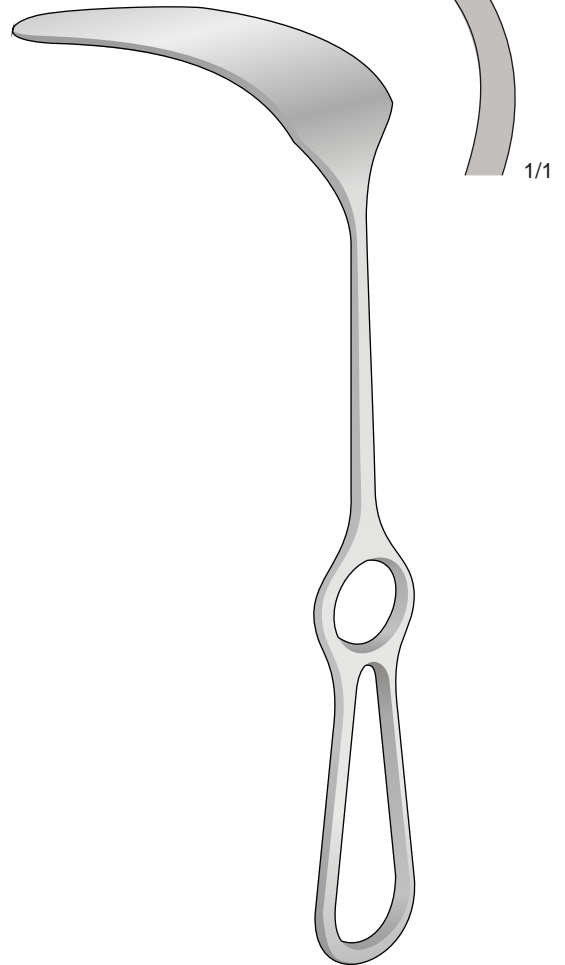
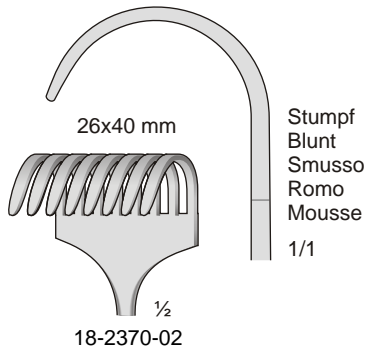
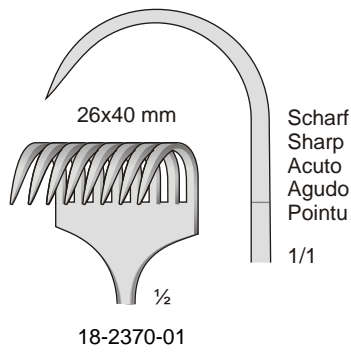

MIKULICZ
18-2380
260 mm

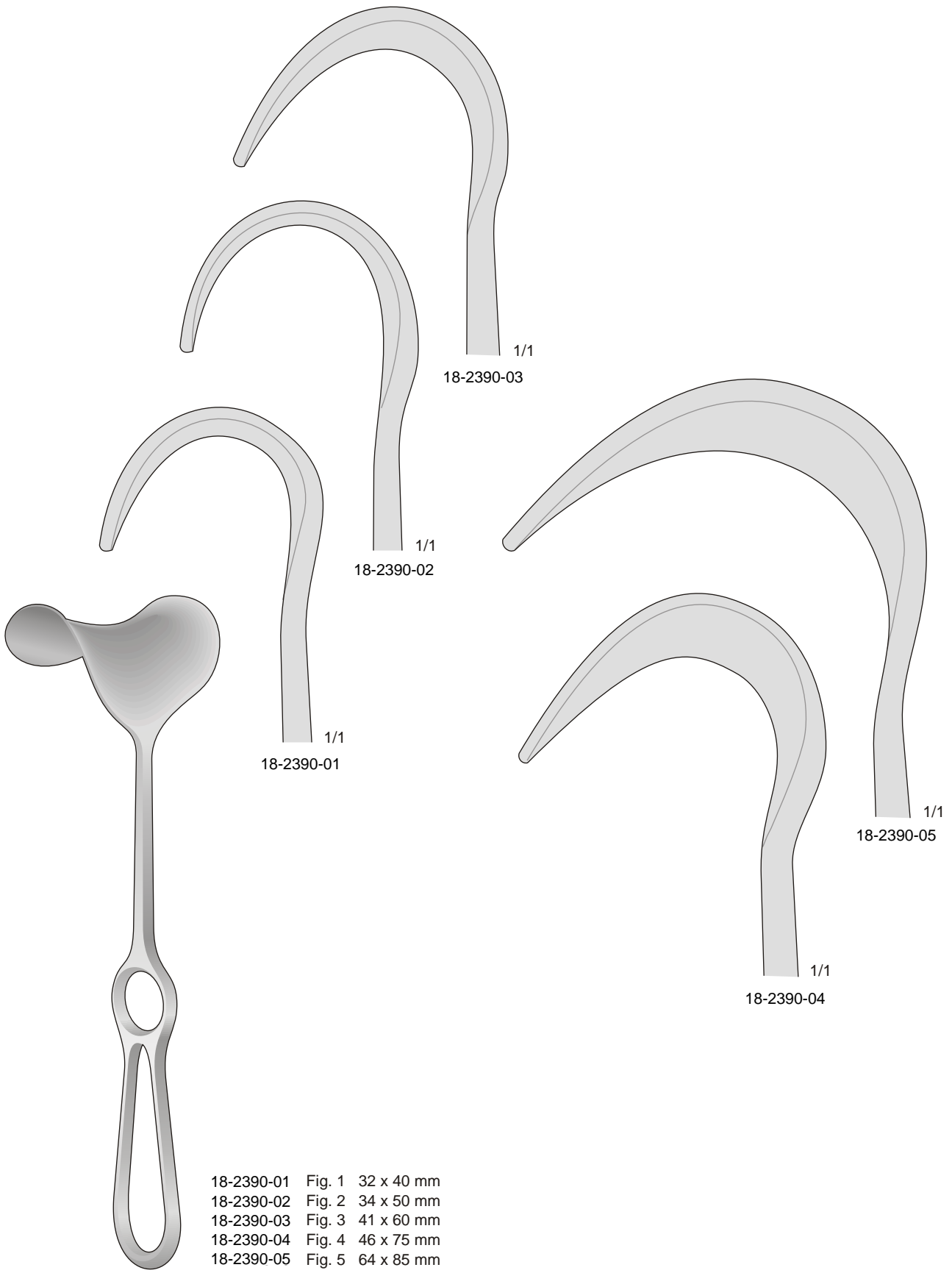

18-2390-01 Fig. 1 32 x 40 mm
 18-2390-02 Fig. 2 34 x 50 mm
 18-2390-03 Fig. 3 41 x 60 mm
 18-2390-04 Fig. 4 46 x 75 mm
 18-2390-05 Fig. 5 64 x 85 mm

FRITSCH
18-2390
240 mm

Pelvishaken
Pelvis retractors

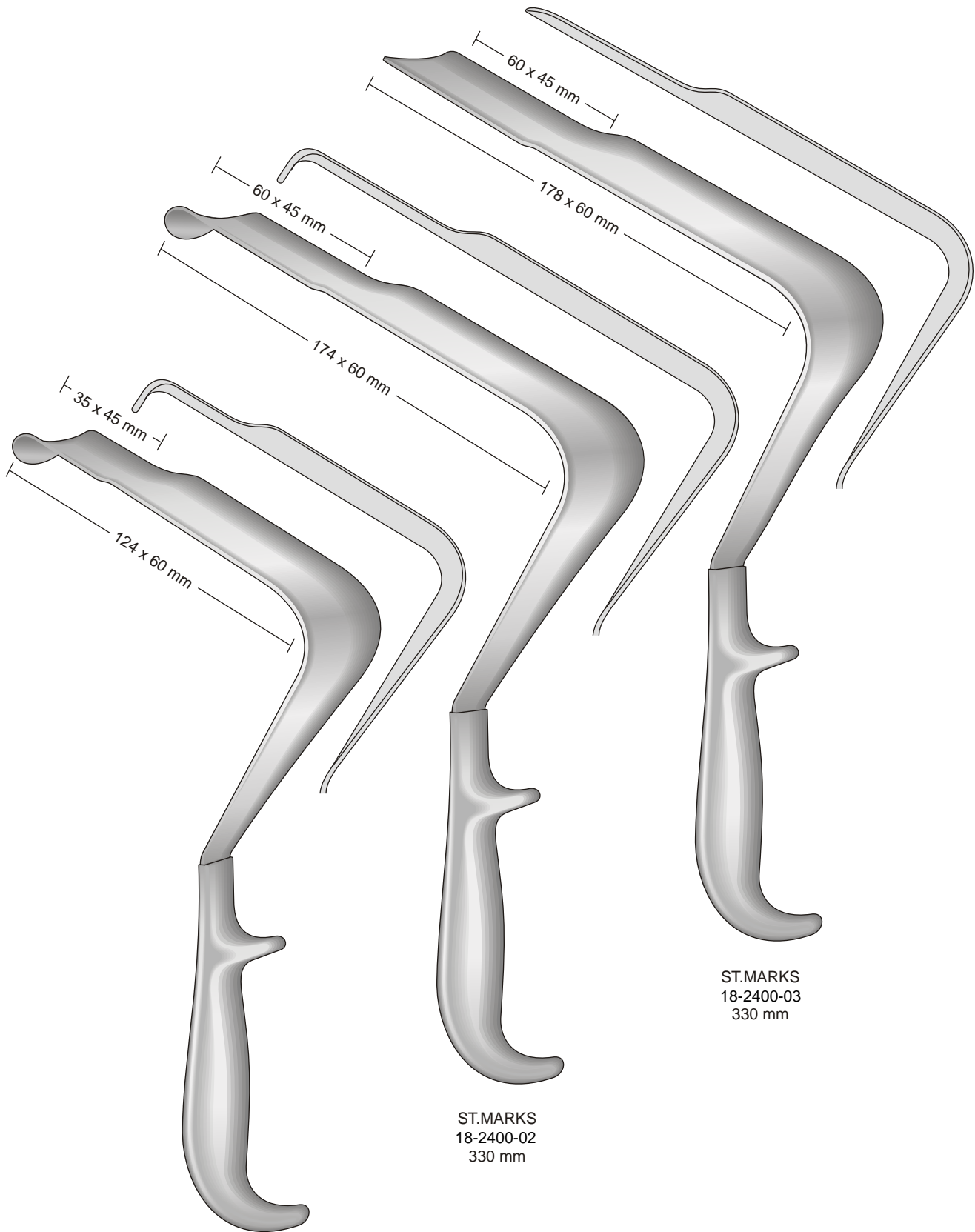

ST.MARKS
18-2400-01
290 mm

ST.MARKS
18-2400-02
330 mm

ST.MARKS
18-2400-03
330 mm

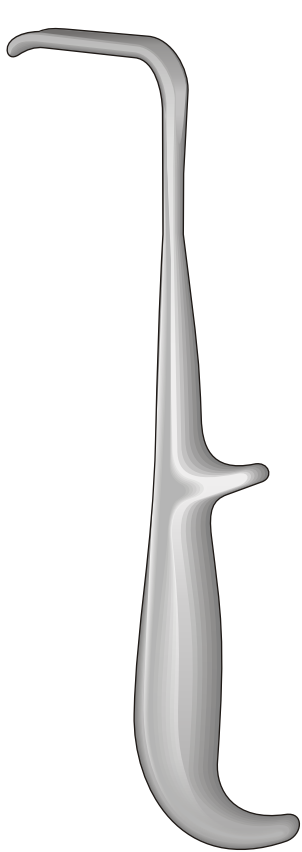
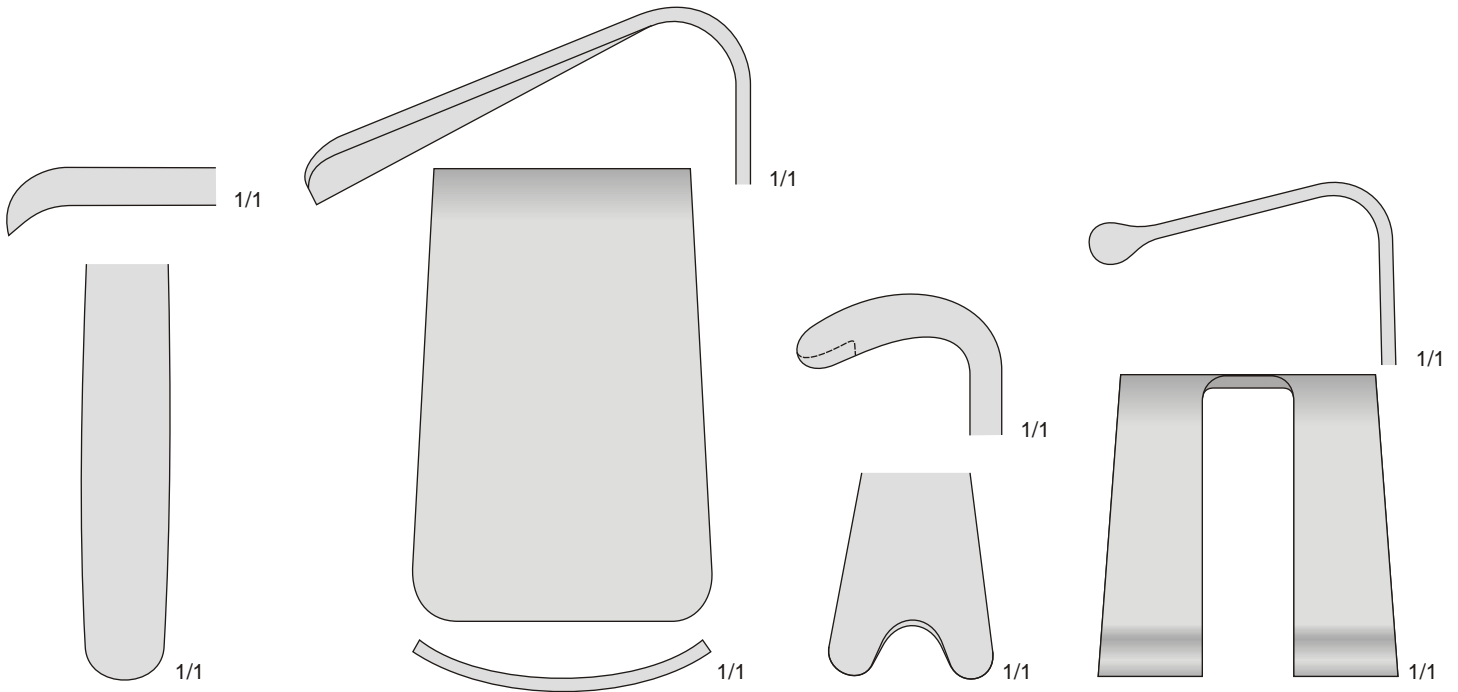

YOUNG
18-2410-01
215 mm

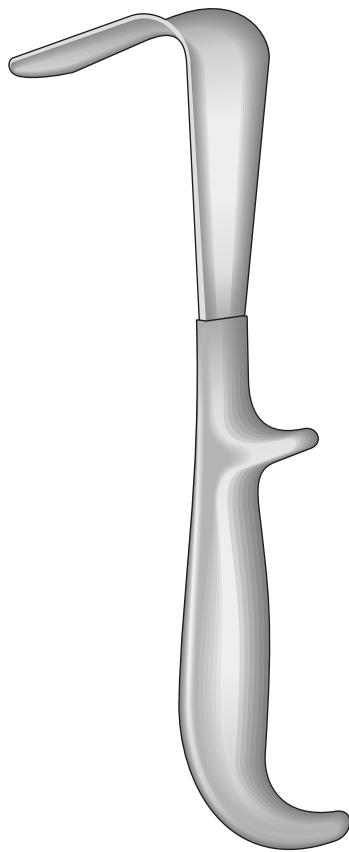

YOUNG
18-2410-02
210 mm

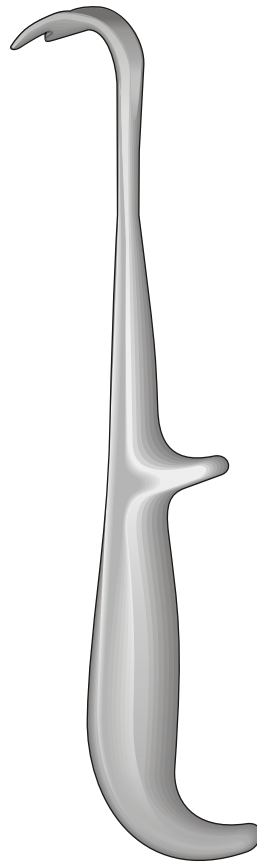

YOUNG
18-2420-01
220 mm

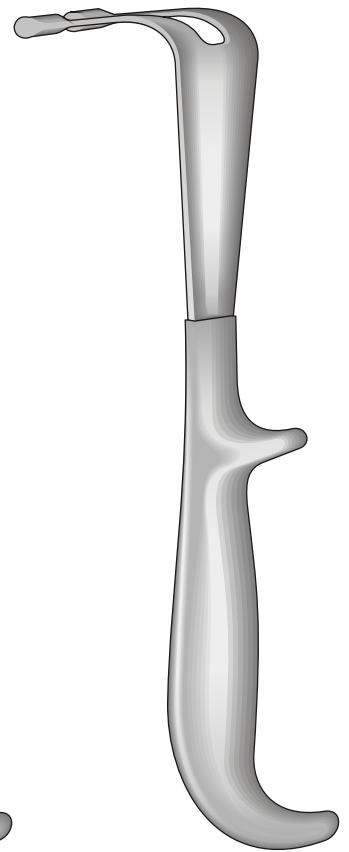

YOUNG
18-2420-02
210 mm

new

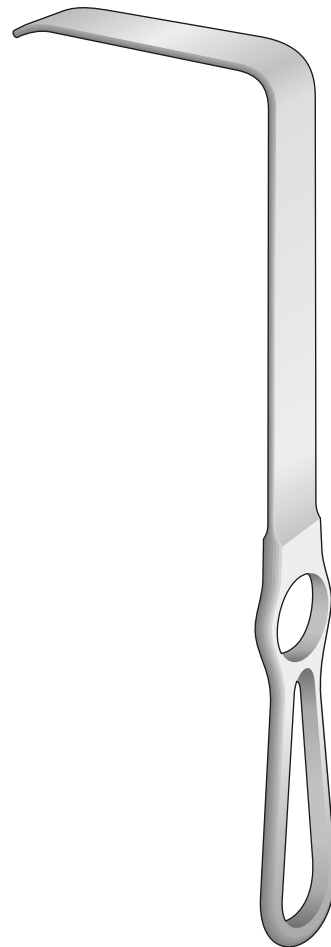
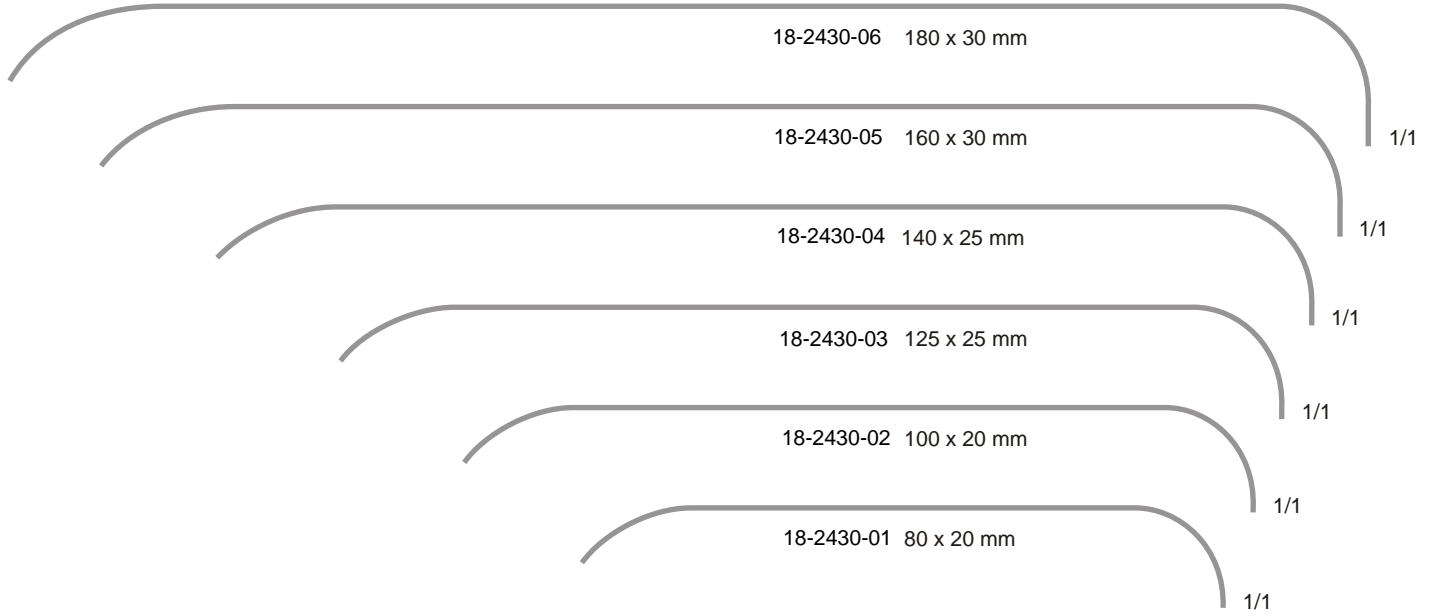

BRUNNER
18-2430
250 mm

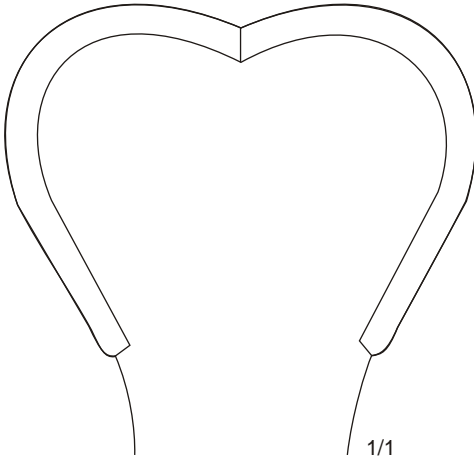

HARRINGTON-PEMBERTON
18-2440-29 175 x 64 mm
295 mm

← 137 mm →

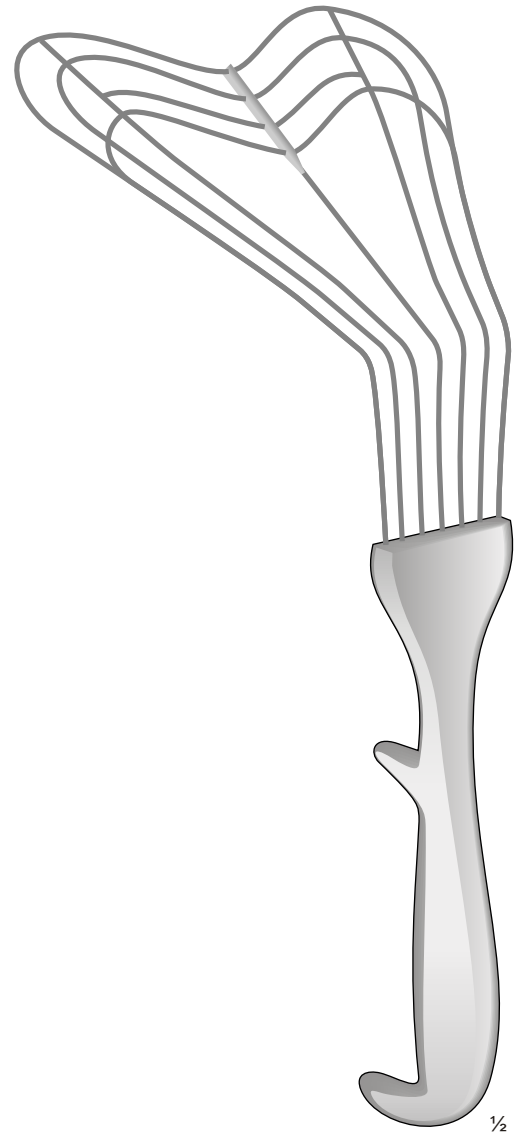

18-2450-30
300 mm

Gefaßclips - Vessel Clips
Clamps vascolari - Clamps vasculares
Clamps vasculaires

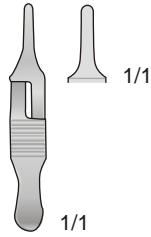

DIEFFENBACH
18-2460-01
30 mm

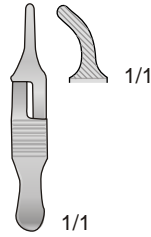

DIEFFENBACH
18-2460-02
30 mm

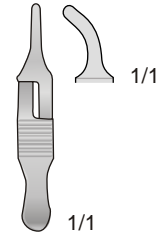

DIEFFENBACH
18-2460-03
30 mm

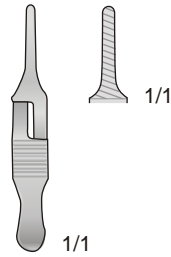

DIEFFENBACH
18-2460-04
30 mm

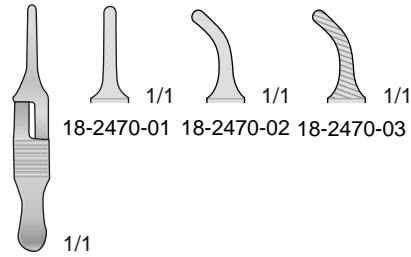

DIEFFENBACH
18-2470
35 mm

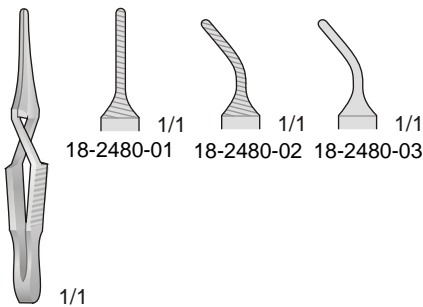

18-2480
40 mm

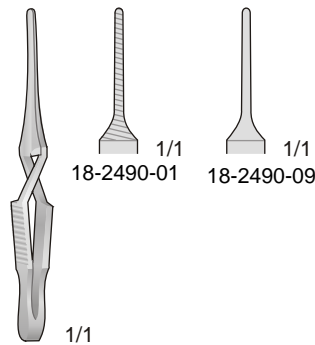

18-2490
45 mm

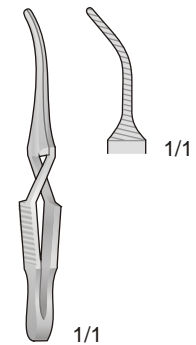

45 mm

Komplettsset mit 3 Haken Stripper - Set complete with 3 Vein Stripper
Set completo con 3 uncini per vene - Set completo con 3 sondas para verices
Set complete avec 3 stripper a anneau

Fig. 1

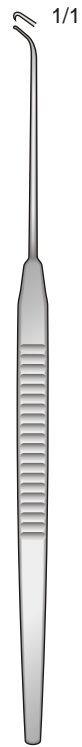

18-2500-01
140 mm

Fig. 2

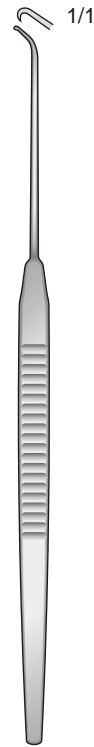

18-2500-02
140 mm

Fig. 3

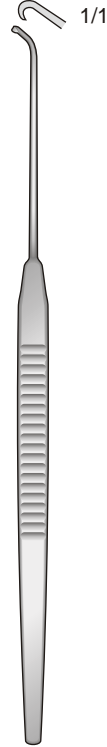

18-2500-03
140 mm

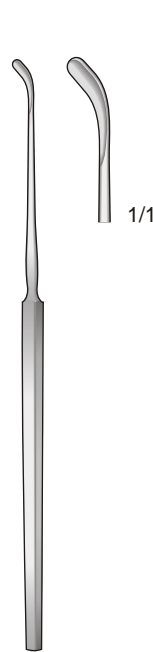

ZAUFAL
18-2510-16 160 mm
18-2510-20 200 mm
18-2510

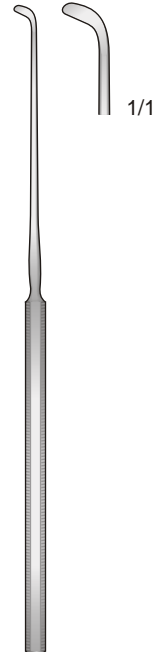

JANSEN-NEWHART
18-2520-17
170 mm

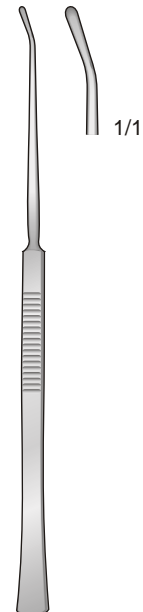

YANKAUER
18-2530-16
160 mm

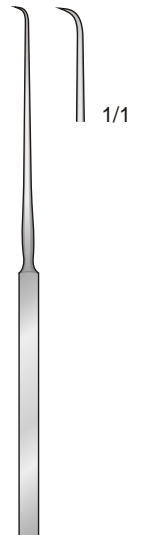

WAGNER
18-2510-14
140 mm

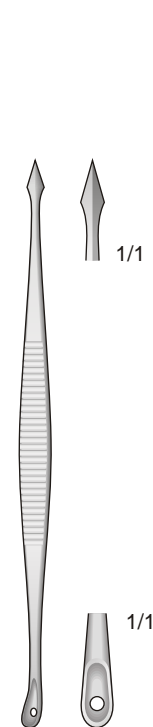

SAALFELD
18-2550-10
100 mm

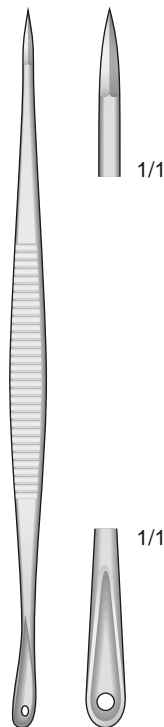

SAALFELD
18-2550-14
140 mm

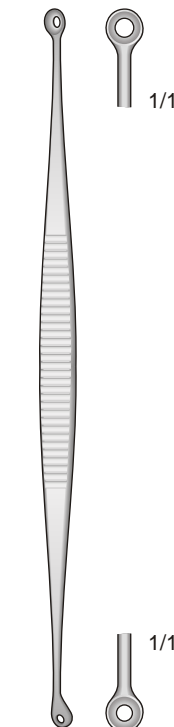

UNNA
18-2560-01
140 mm

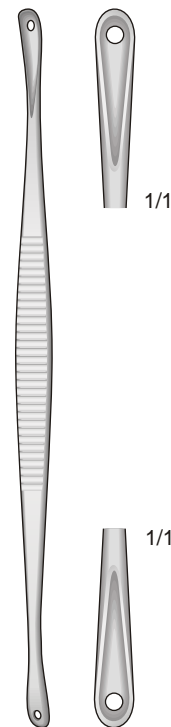

UNNA
18-2560-02
140 mm

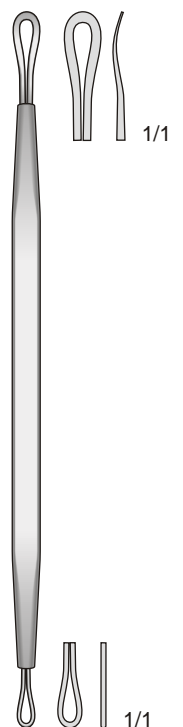

18-2570-13
130 mm

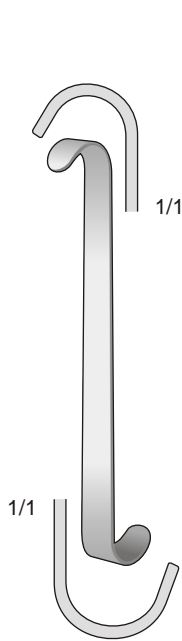

LUER
18-2620-11
110 mm

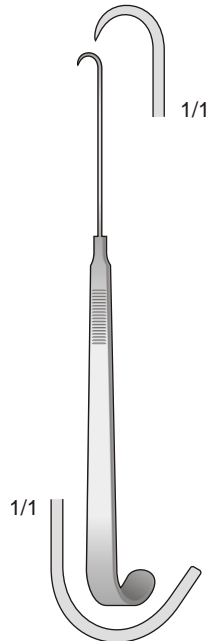

NEWS
18-2630-15
150 mm

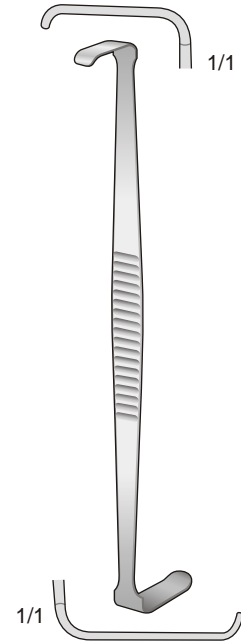

HOUSE
18-2640-15
150 mm

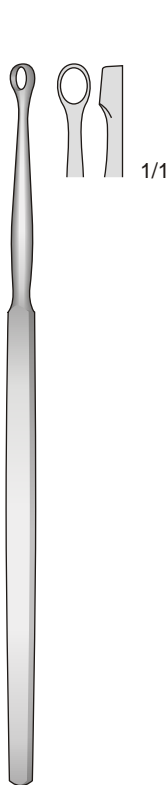

FOX
18-2650
140 mm

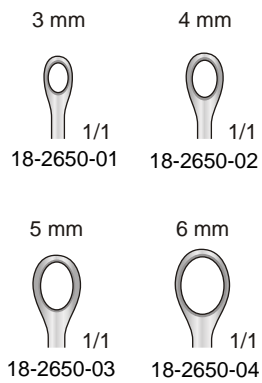

WOLF
18-2660
140 mm

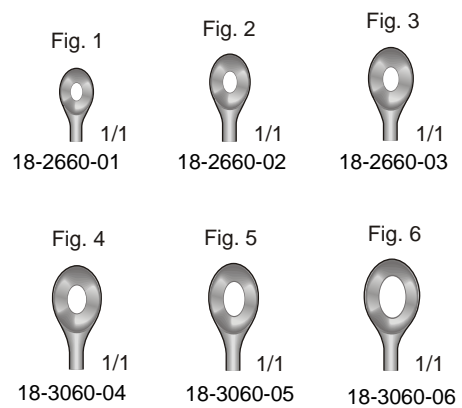

Raspatorien
Periosteal Elevators
Raspatori - Elevatori

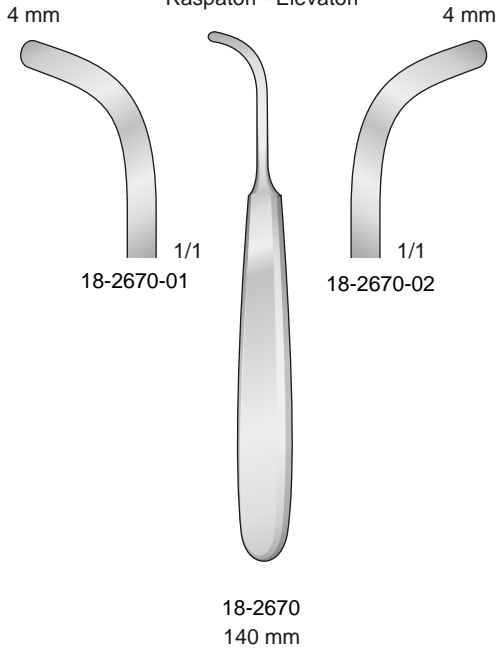

new

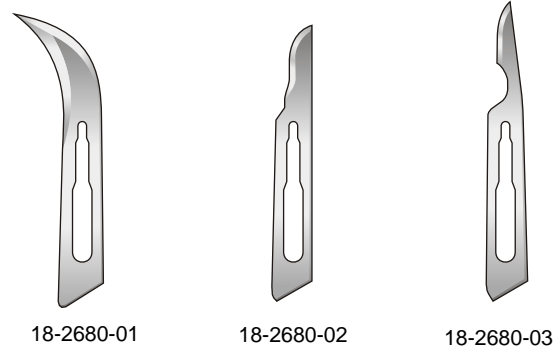

Stumpf
Blunt
Smussa
Romas
Mousse

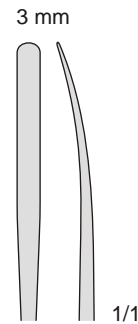

Stumpf
Blunt
Smussa
Romas
Mousse

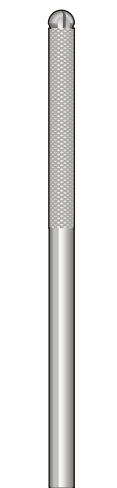
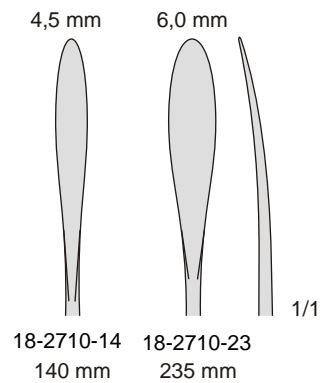

18-2690-01
100 mm

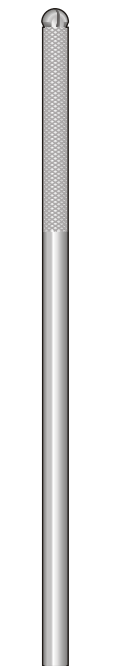

18-2690-02
130 mm

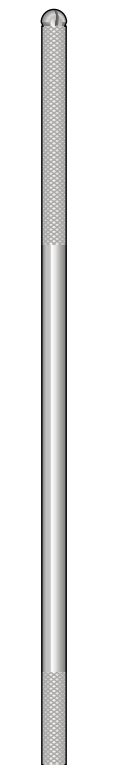

18-2690-03
150 mm

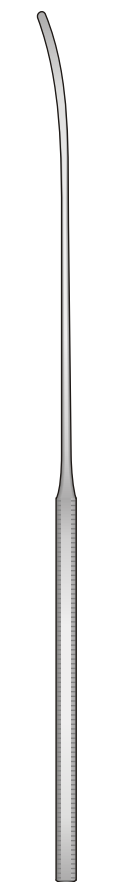

18-2700-18
180 mm

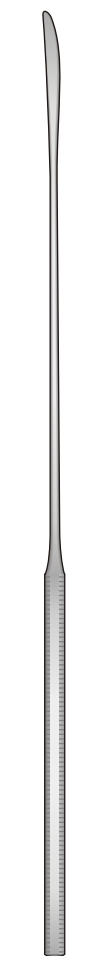

18-2710

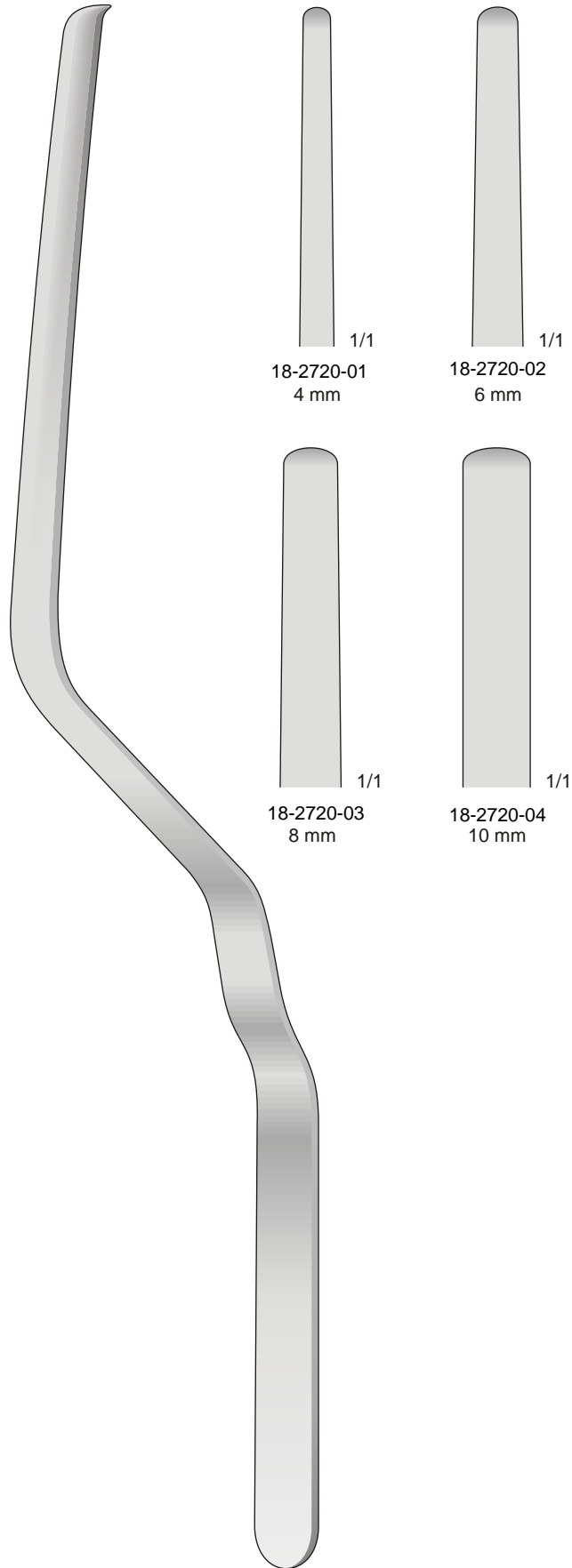

18-2720-01
4 mm

18-2720-02
6 mm

18-2720-03
8 mm

18-2720-04
10 mm

CASPAR
18-2720
240 mm

Femur-Wundspreizer für kinder
Femur Retractor for children
Divaricatore femorale per bambini

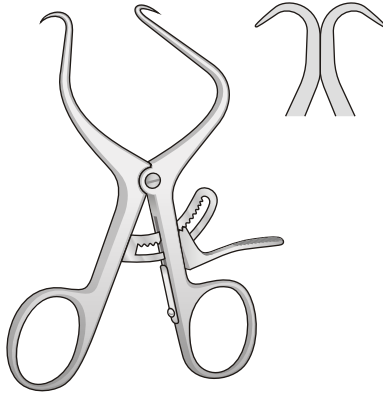

DE BAKEY
18-2730-10
100 mm

Femur-Wundspreizer
Femur Retractor
Divaricatore femorale

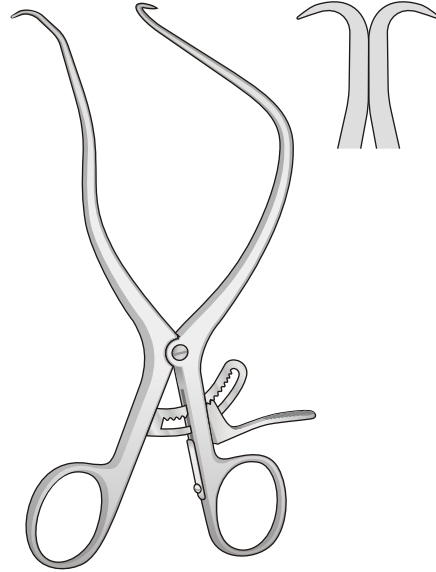

DE BAKEY
18-2730-17
170 mm

Wundspreizer
Retractors for shoulder
Divaricatori da spalla
Separadores
Ecarteurs

Stumpf - Blunt
Smusso - Romo
Mousse

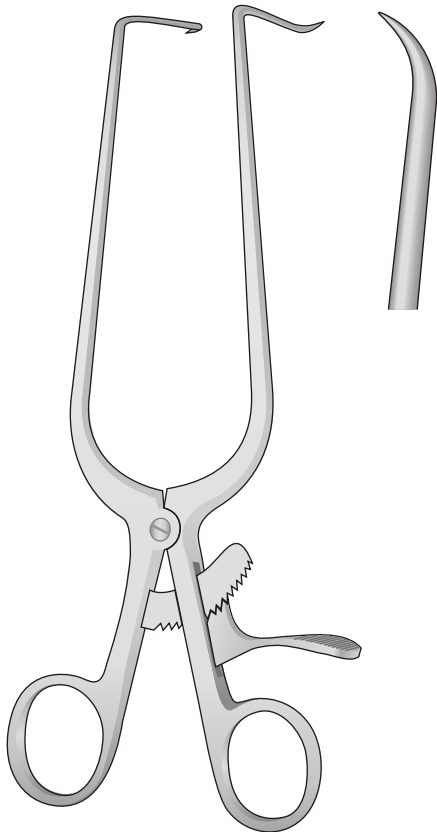

18-2740-21
215 mm

Stumpf - Blunt
Smusso - Romo
Mousse

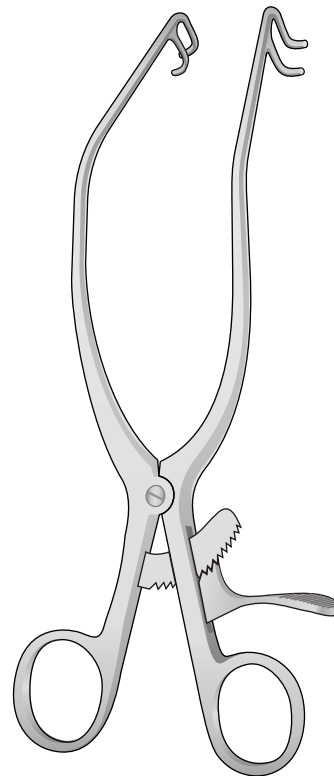

KÖLBEL
18-2750-18
180 mm



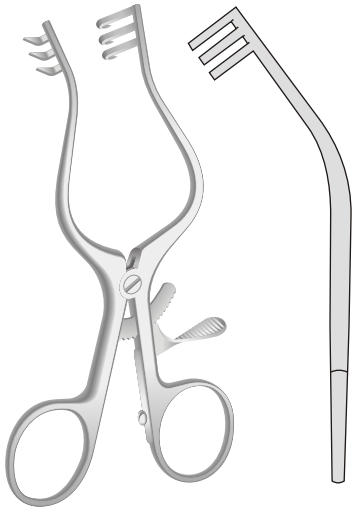
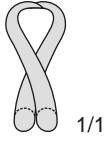

Scharf
Sharp
Acuto
Agudo
Pointu

WULLSTEIN
18-2760-01
130 mm

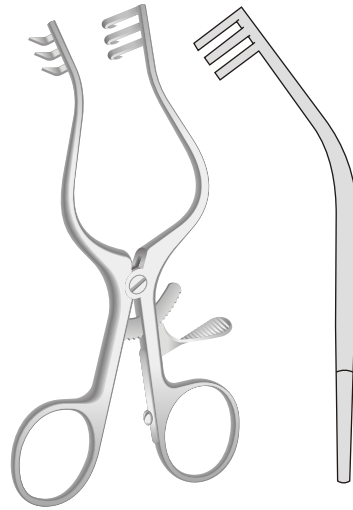

Stumpf
Blunt
Smusso
Romo
Mousse

WULLSTEIN
18-2760-02
130 mm

Scharf
Sharp
Acuto
Agudo
Pointu

Stumpf
Blunt
Smusso
Romo
Mousse

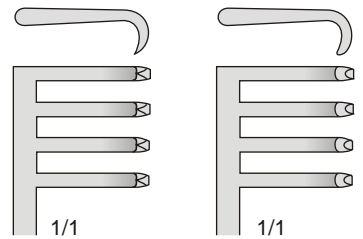

18-2770-01

18-2770-02

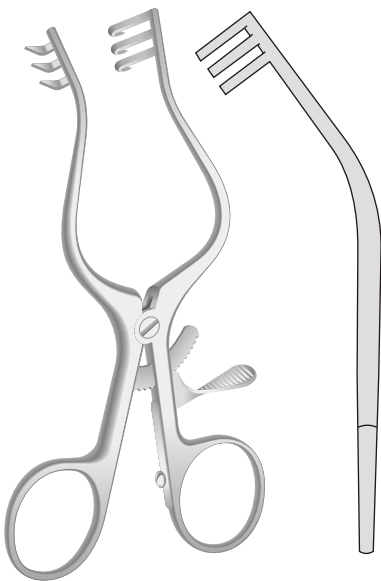
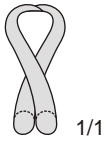

Scharf
Sharp
Acuto
Agudo
Pointu

WULLSTEIN
18-2760-03
160 mm

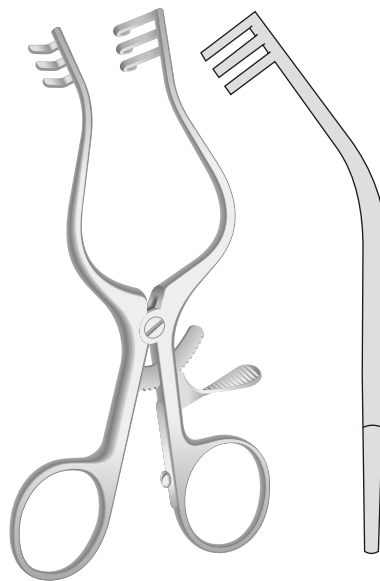

Stumpf
Blunt
Smusso
Romo
Mousse

WULLSTEIN
18-2760-04
160 mm



SCALP-CONTOUR
18-2770
135 mm

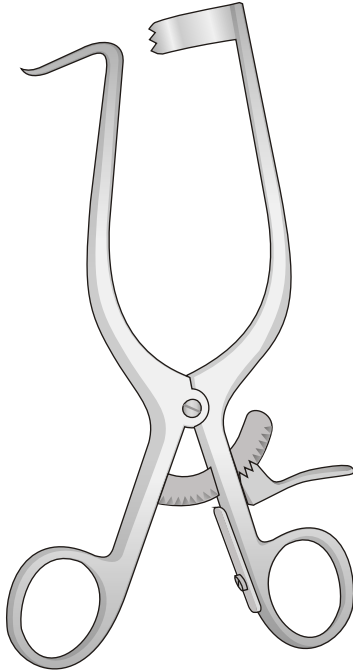

WILLIAMS
18-2780
170 mm

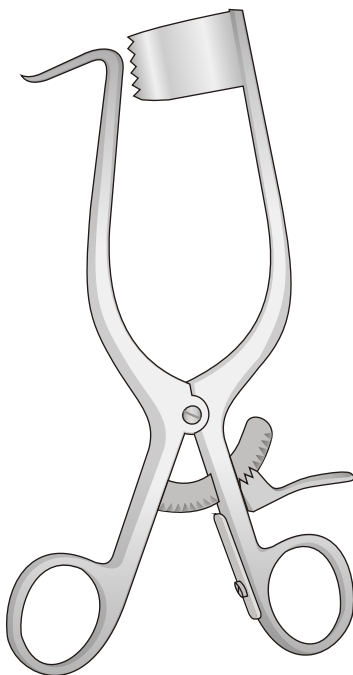
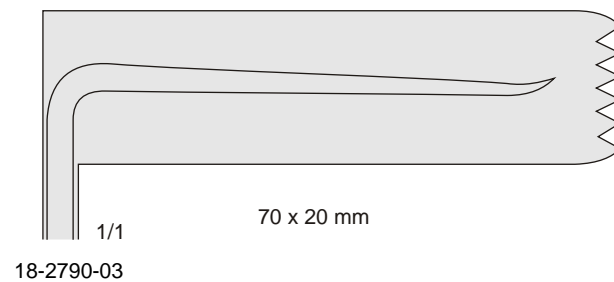
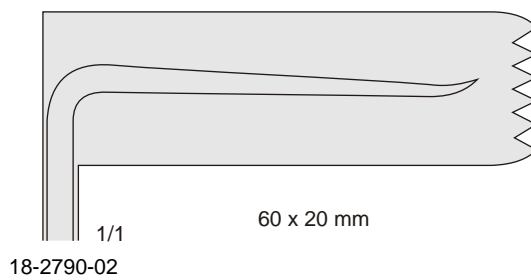
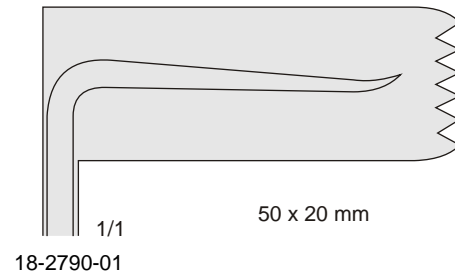
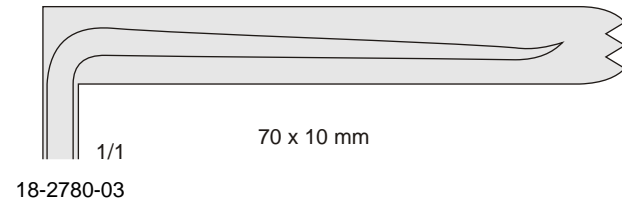
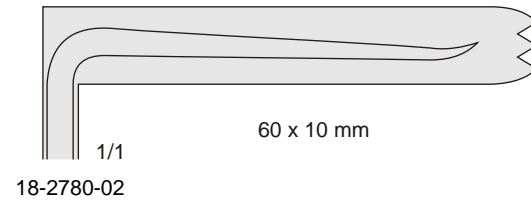
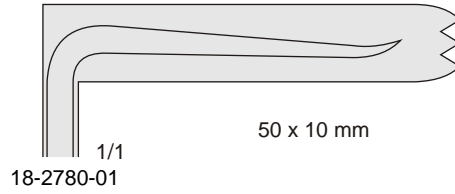

WILLIAMS
18-2790
170 mm

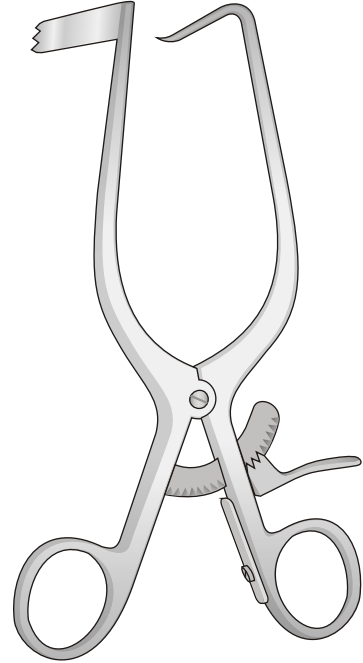
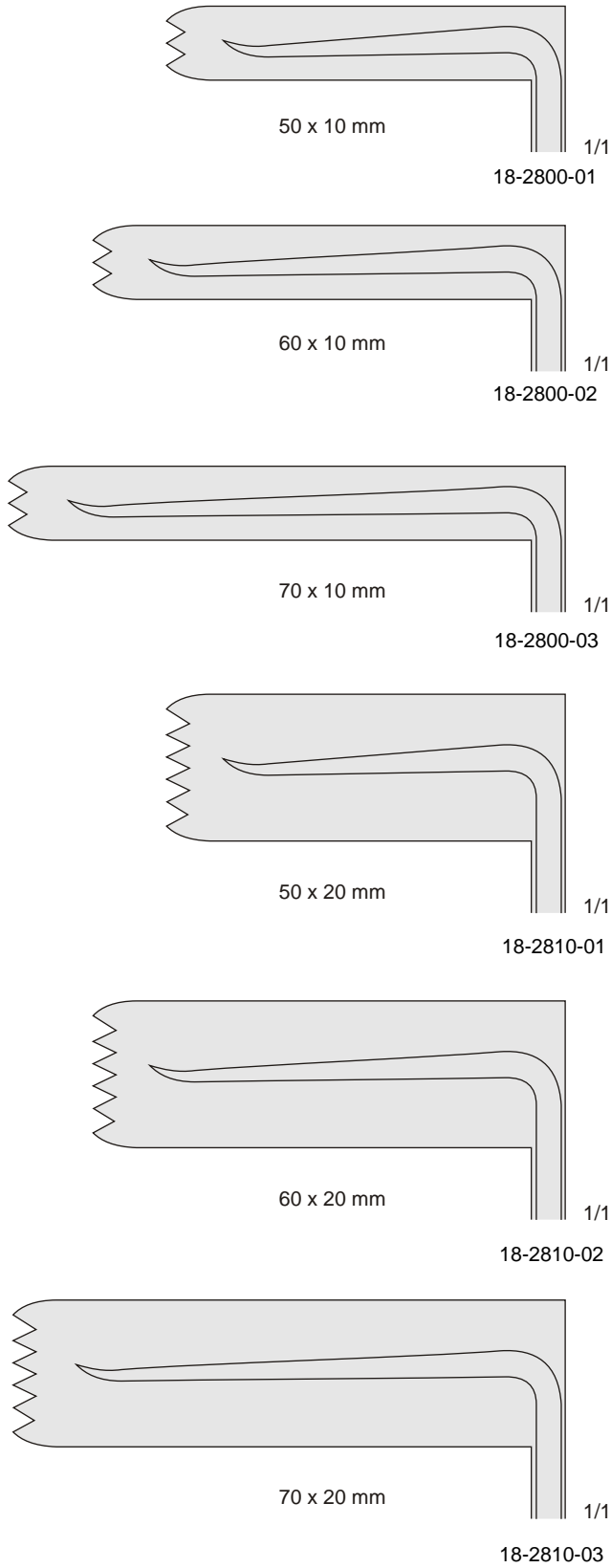

WILLIAMS
18-2800
170 mm

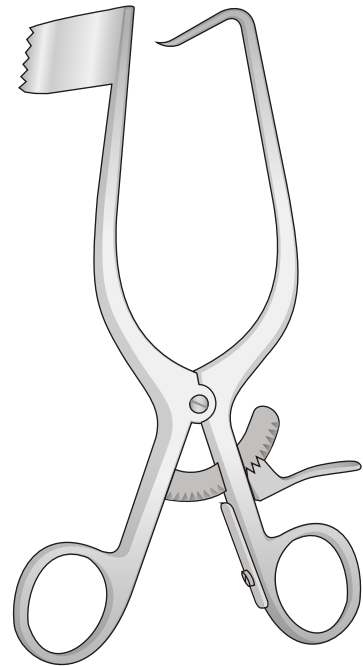

WILLIAMS
18-2810
170 mm

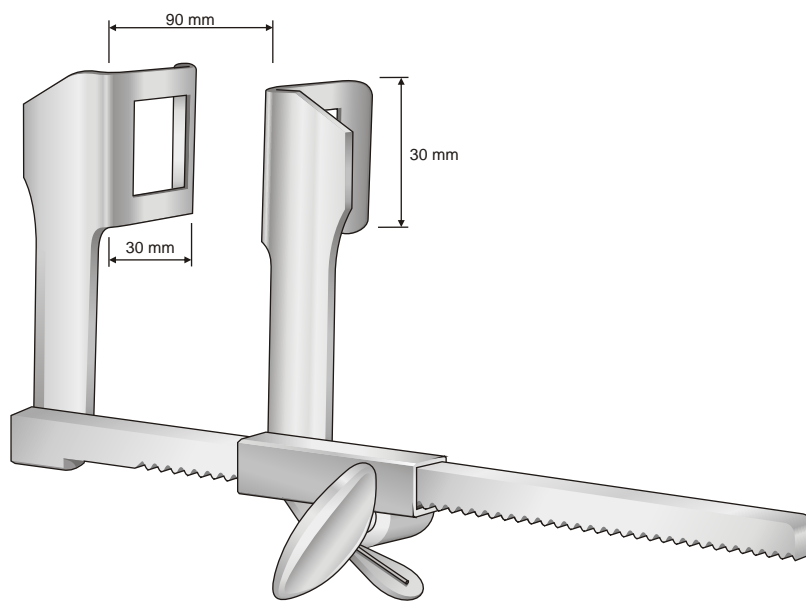

HAIGHT
18-2820

CASPAR
18-2830
Distraktor komplett rechts
Distractor complete right
Distrattore completo destro
18-2840-01 1 Distraktor allein - 1 Distractor only
18-2850-01 1 Bohrbüchse - 1 Drilling Guide
18-2860-01 1 Spezialbohrer - 1 Special Drill
18-2860-02 2 Distraktionsschrauben - 2 Distraction Screws
18-2860-03 1 Schraubendreher - 1 Screw Driver

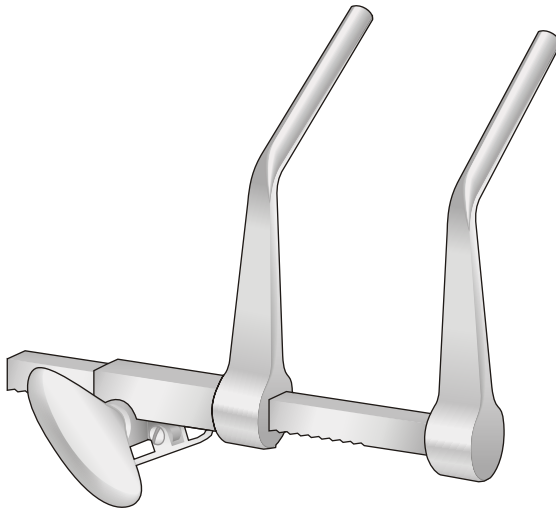

CASPAR
18-2840-01
Distraktor rechts, Allein
Distractor right, Only
Distrattore destro, solo

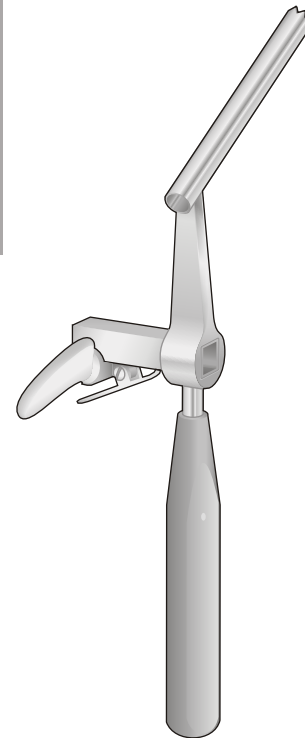

18-2850-01
Bohrbüchse rechts, Allein
Drilling Guide right, Only
Guida punte destro, solo

CASPAR
18-2840
Distraktor komplett links
Distractor complete left
Distrattore completo sinistro
18-2840-02 1 Distraktor allein - 1 Distractor only
18-2850-02 1 Bohrbüchse - 1 Drilling Guide
18-2860-01 1 Spezialbohrer - 1 Special Drill
18-2860-02 2 Distraktionsschrauben - 2 Distraction Screws
18-2860-03 1 Schraubendreher - 1 Screw Driver

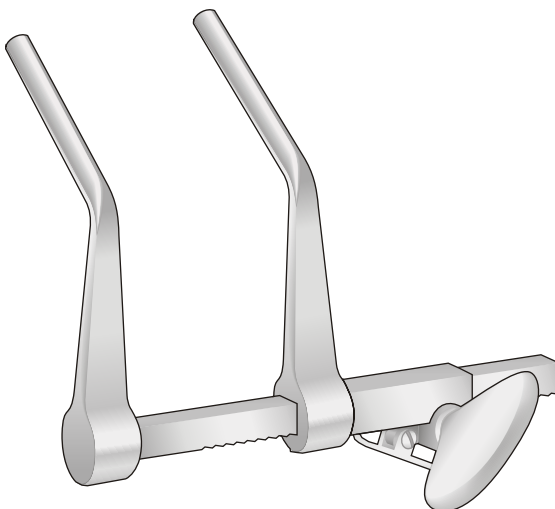

CASPAR
18-2840-02
Distraktor links, Allein
Distractor left, Only
Distrattore sinistro, solo

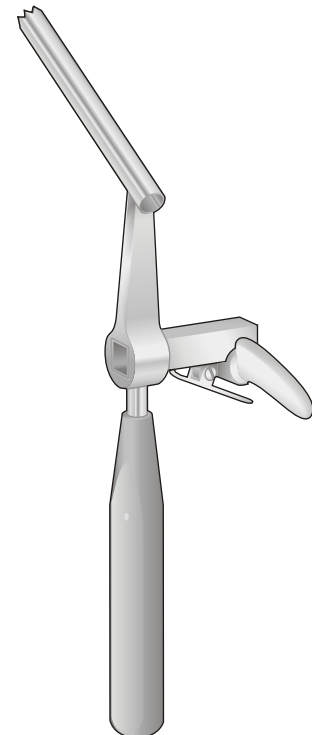

18-2850-02
Bohrbüchse links, Allein
Drilling Guide left, Only
Guida punte sinistro, solo

Screw Driver
Schraubendreher



CASPAR
18-2860-20
200 mm

Special Drill
Spezialbohrer
Ø 1,7 mm

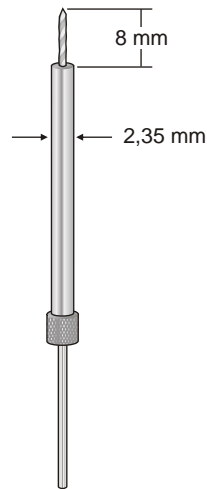

CASPAR
18-2860-01
145 mm

Distraction Screw
Distractionsschrauben

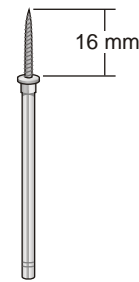

CASPAR
18-2860-02
70 mm

CASPAR

Distraktor komplett links
Distractor complete left
Distrattore completo sinistro

- 1 Distraktor allein - 1 Distractor only
- 1 Bohrbüchse - 1 Drilling Guide
- 1 Spezialbohrer - 1 Special Drill
- 2 Distractionsschrauben - 2 Distraction Screws
- 1 Schraubendreher - 1 Screw Driver

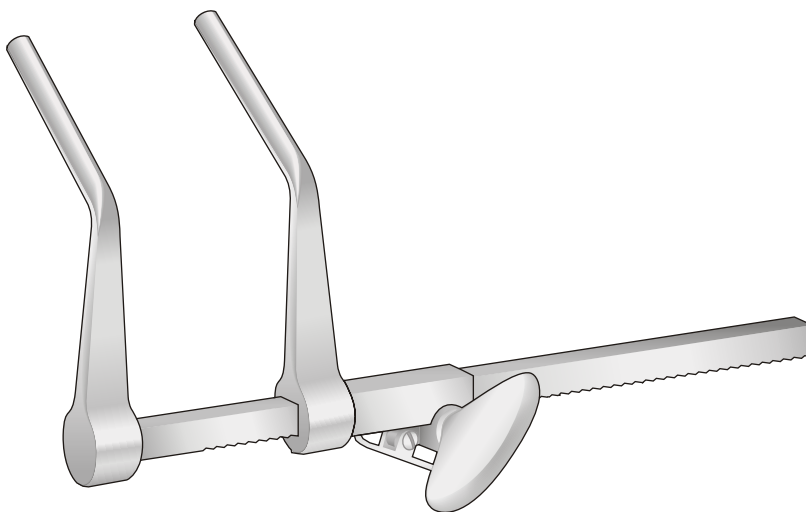

CASPAR
18-2840-02
Distraktor links, Allein
Distractor left, Only
Distrattore sinistro, solo

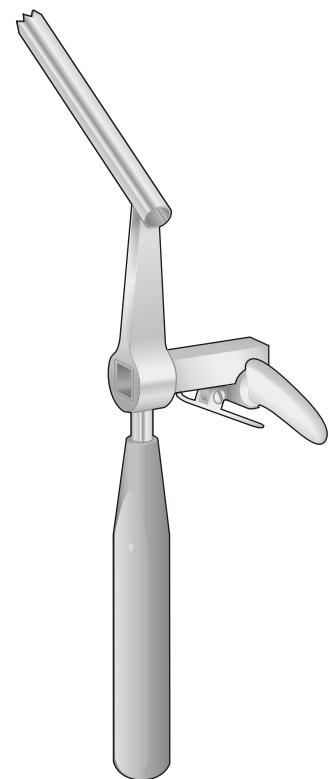

18-2850-02
Bohrbüchse links, Allein
Drilling Guide left, Only
Guida punte sinistro, solo

Special Drill
Spezialbohrer
Ø 1,7 mm

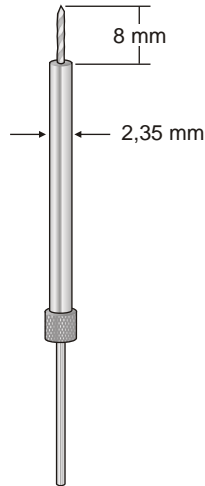

CASPAR
18-2860-01
145 mm

Distraction Screw
Distraktionsschrauben

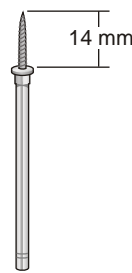

CASPAR
18-2860-02
70 mm

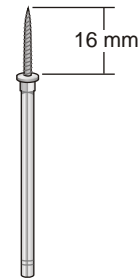

CASPAR
18-2860-03
70 mm

Screw Driver
Schraubendreher



CASPAR
18-2860-20
200 mm

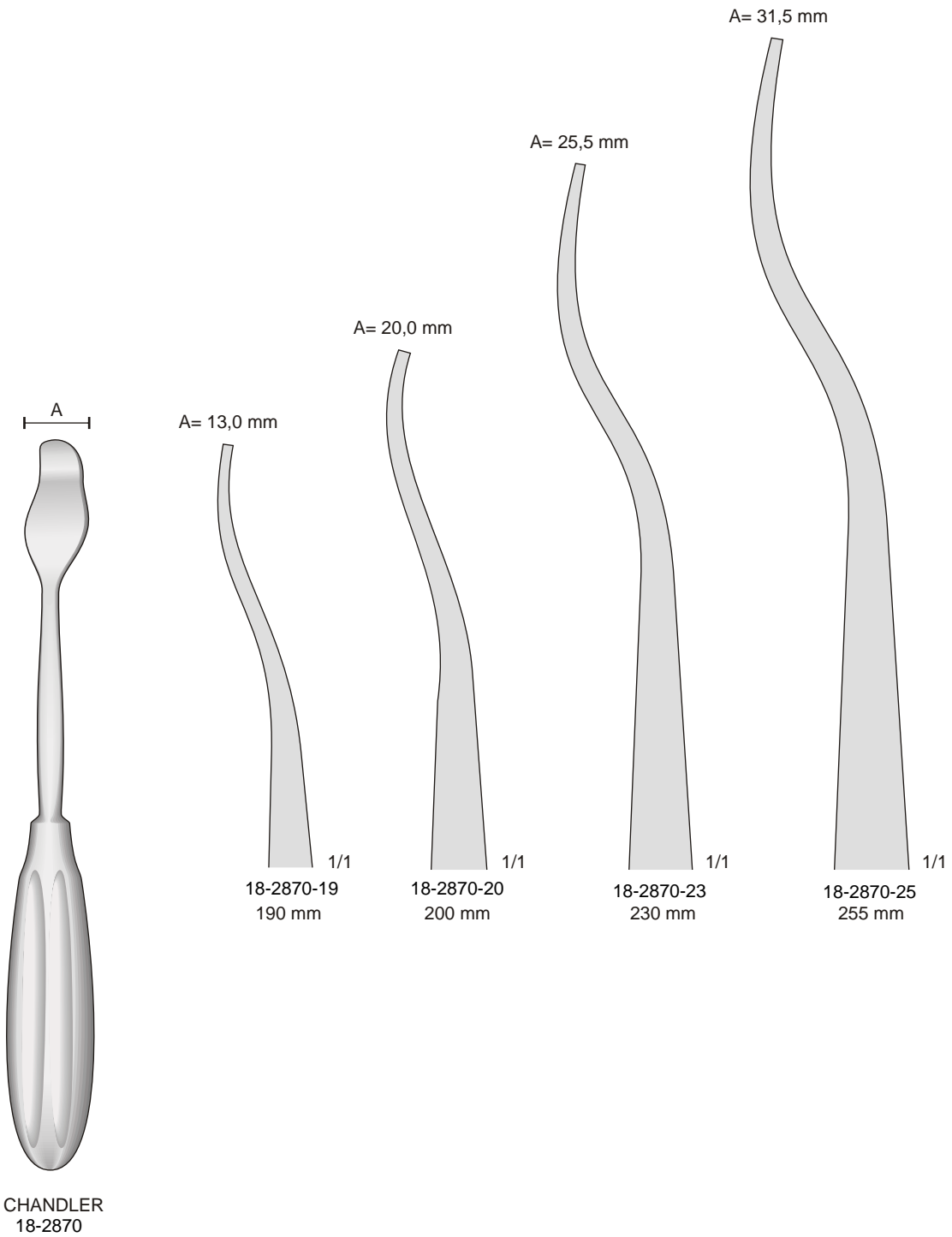

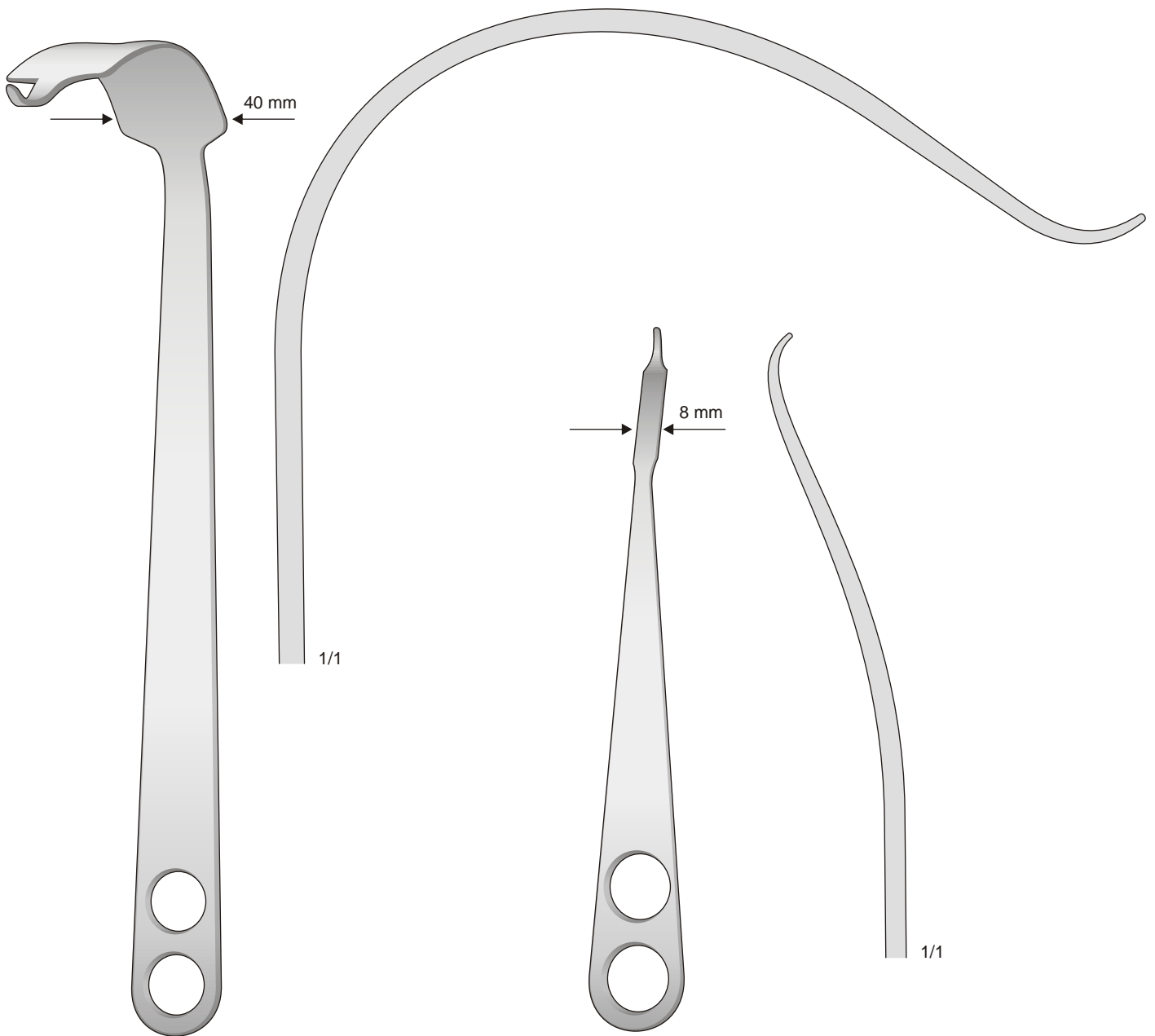

HOHMANN
18-2880-30
330 mm

HOHMANN
18-2880-22
225 mm

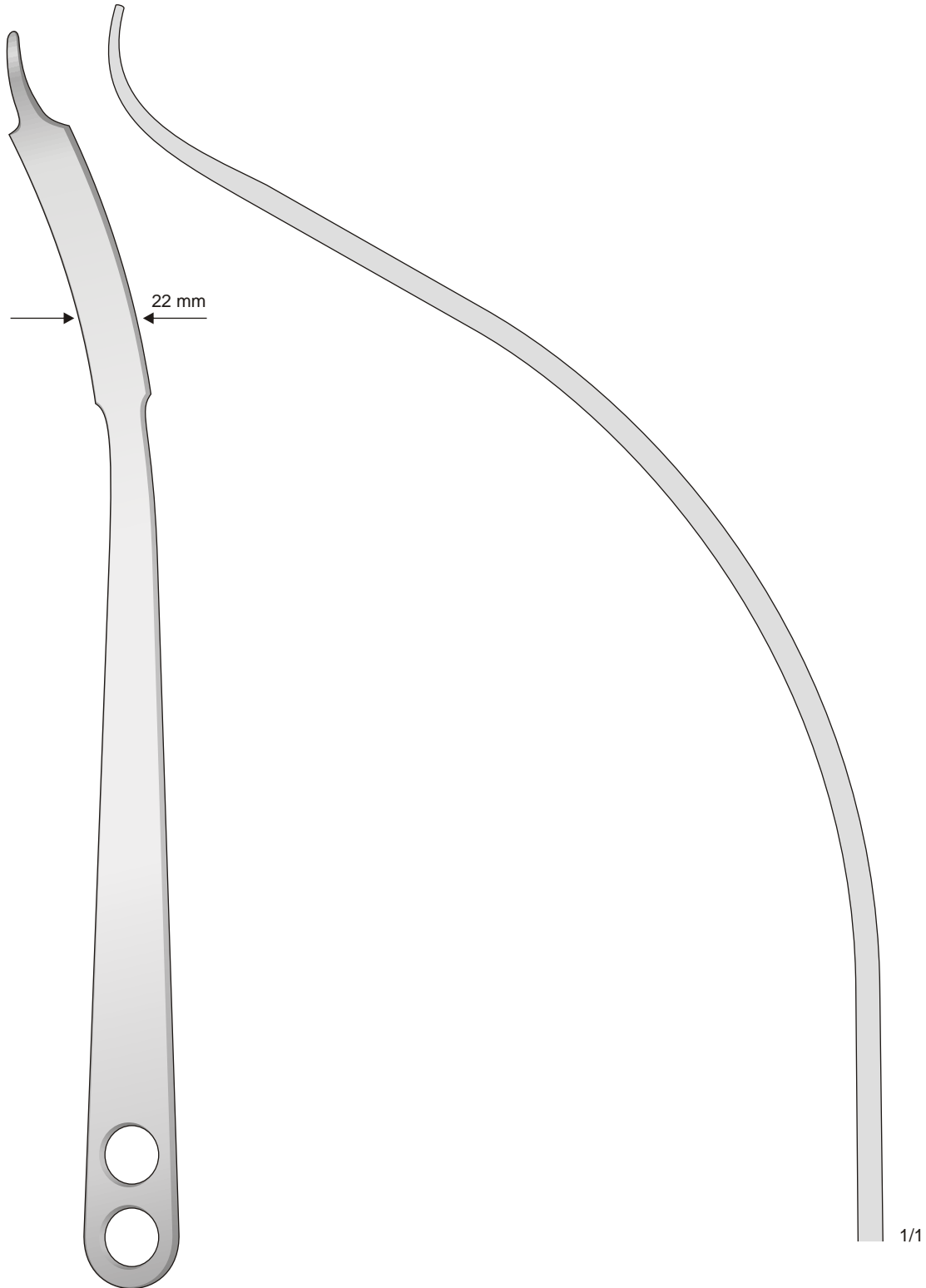

HOHMANN
18-2880-40
400 mm

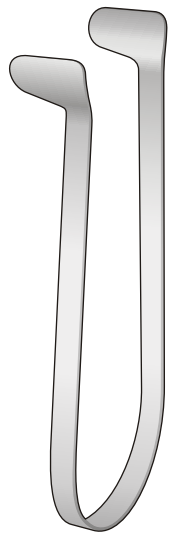

THUDICUM
18-2890

Fig. 1

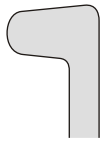

18-2890-01

Fig. 2

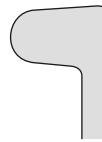

18-2890-02

Fig. 3

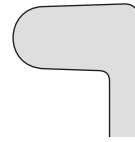

18-2890-03

Fig. 4

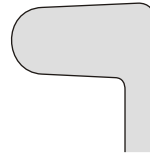

18-2890-04

Fig. 5

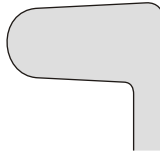

18-2890-05

Fig. 6

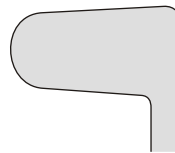

18-2890-06

Fig. 7

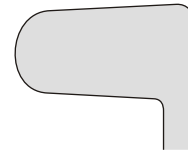

18-2890-07

Zungenspatel - Tongue Depressor
Adenotomie - Tonsillektomie

10 x 13 mm



LACK
18-2900-01

13 x 19 mm

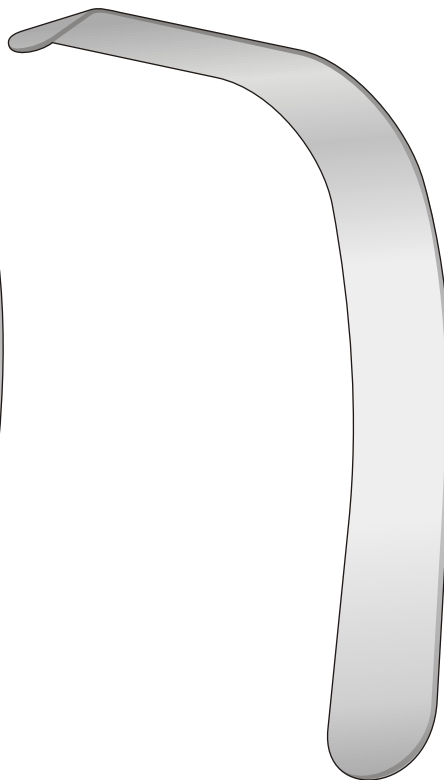

LACK
18-2900-02

15 x 22 mm

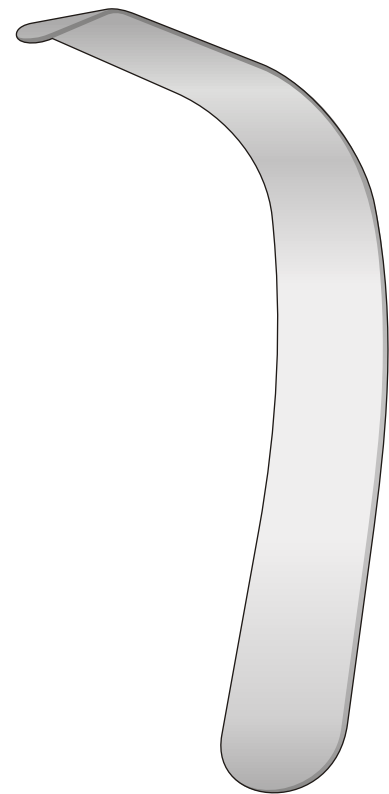

LACK
18-2900-03

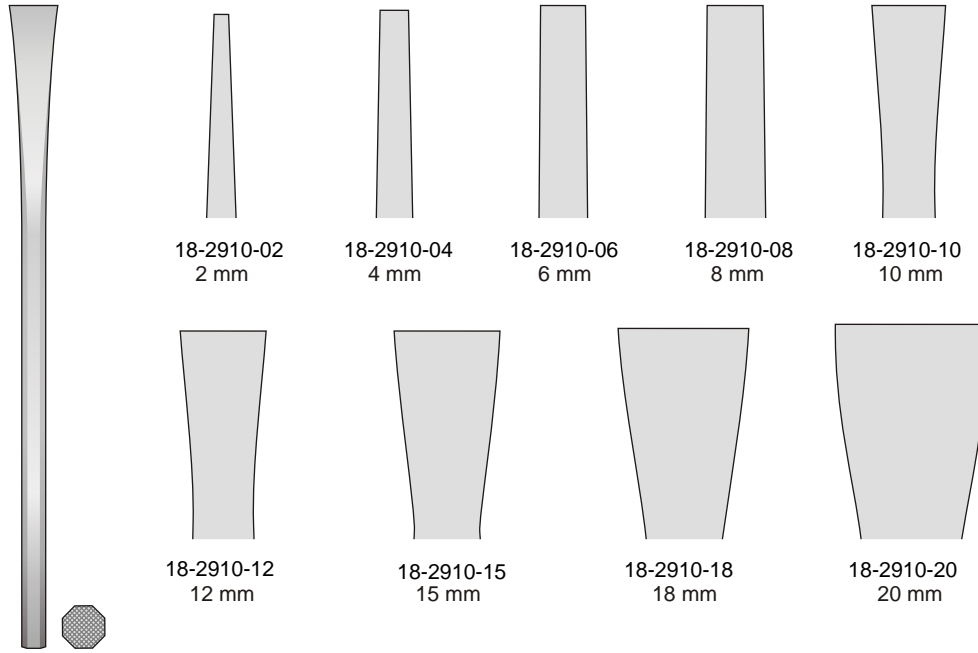

SHEEHAN
18-2910
160 mm

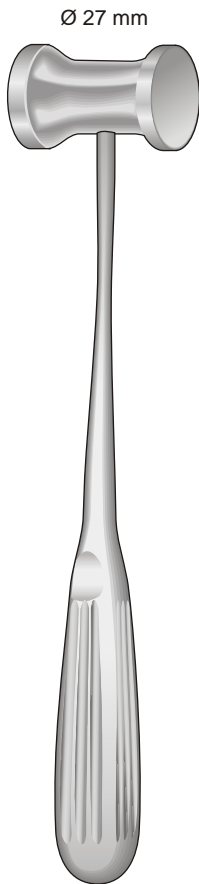

HAJEK
18-2920
220 mm

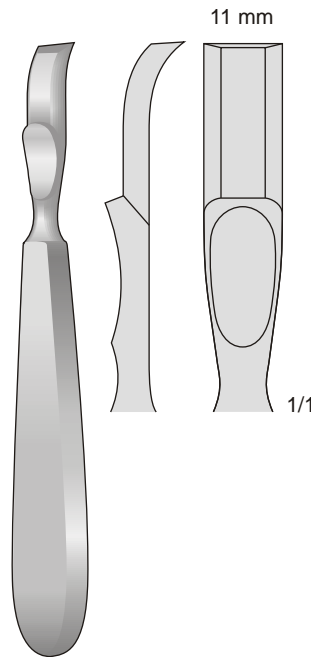

FARABEU-FOLLIN
18-2930-160
160 mm

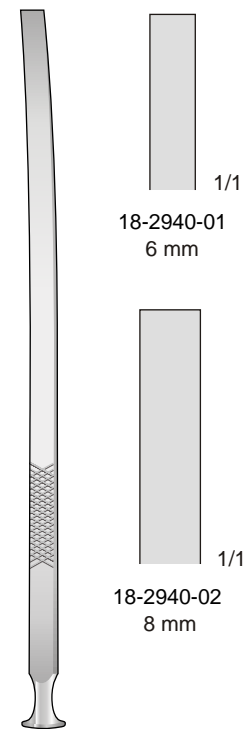

EPKER
18-2940
180 mm

8 mm



COSCIA
18-2950-18
180 mm

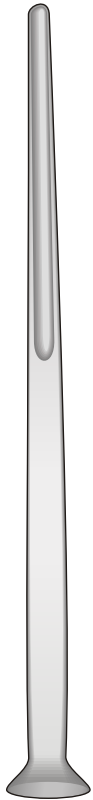

ALEXANDER
18-2960
170 mm

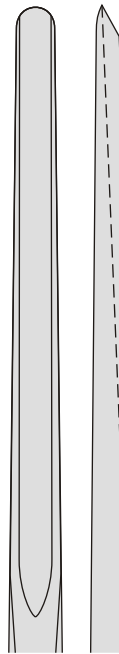

18-2960-05
5 mm

1/1

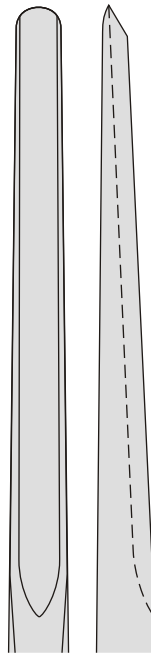

18-2960-07
7 mm

1/1

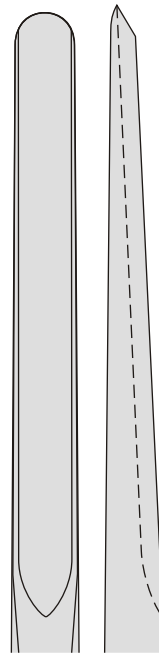

18-2960-09
9 mm

1/1

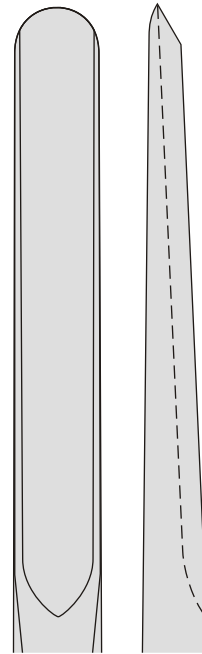

18-2960-11
11 mm

1/1

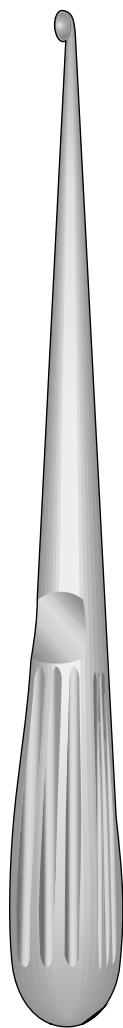

BRUNS
18-2970
170 mm

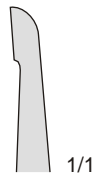

1/1

Fig.5/0
2,2 mm



1/1

18-2970-01

Fig.4/0
2,5 mm



1/1

18-2970-02

Fig.3/0
2,8 mm



1/1

18-2970-03

Fig.2/0
3,3 mm



1/1

18-2970-04

Fig.0
3,6 mm



1/1

18-2970-05

Fig.1
4,3 mm



1/1

18-2970-06

Fig.2
4,8 mm



1/1

18-2970-07

Fig.3
5,6 mm



1/1

18-2970-08

Fig.4
6,0 mm



1/1

18-2970-09

Fig.5
6,7 mm



1/1

18-2970-10

Fig.6
8,8 mm



1/1

18-2970-11

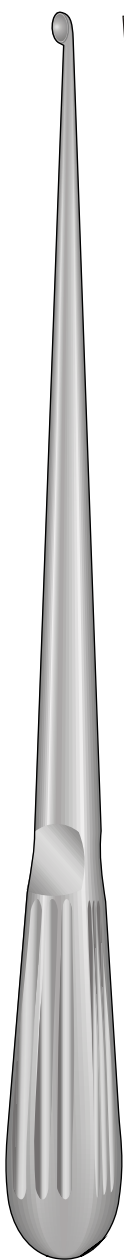

BRUNS
18-2980
225 mm

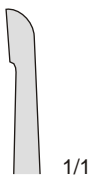









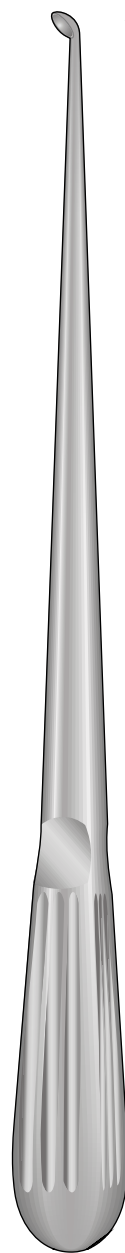

Fig.3/0 2,8 mm  1/1 18-2980-01	Fig.2/0 3,3 mm  1/1 18-2980-02	Fig.0 3,6 mm  1/1 18-2980-03
Fig.1 4,3 mm  1/1 18-2980-04	Fig.2 4,8 mm  1/1 18-2980-05	Fig.3 5,6 mm  1/1 18-2980-06
Fig.4 6,0 mm  1/1 18-2980-07	Fig.5 6,7 mm  1/1 18-2980-08	Fig.6 8,8 mm  1/1 18-2980-09



BRUNS
18-2990
225 mm

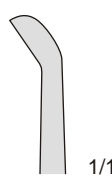









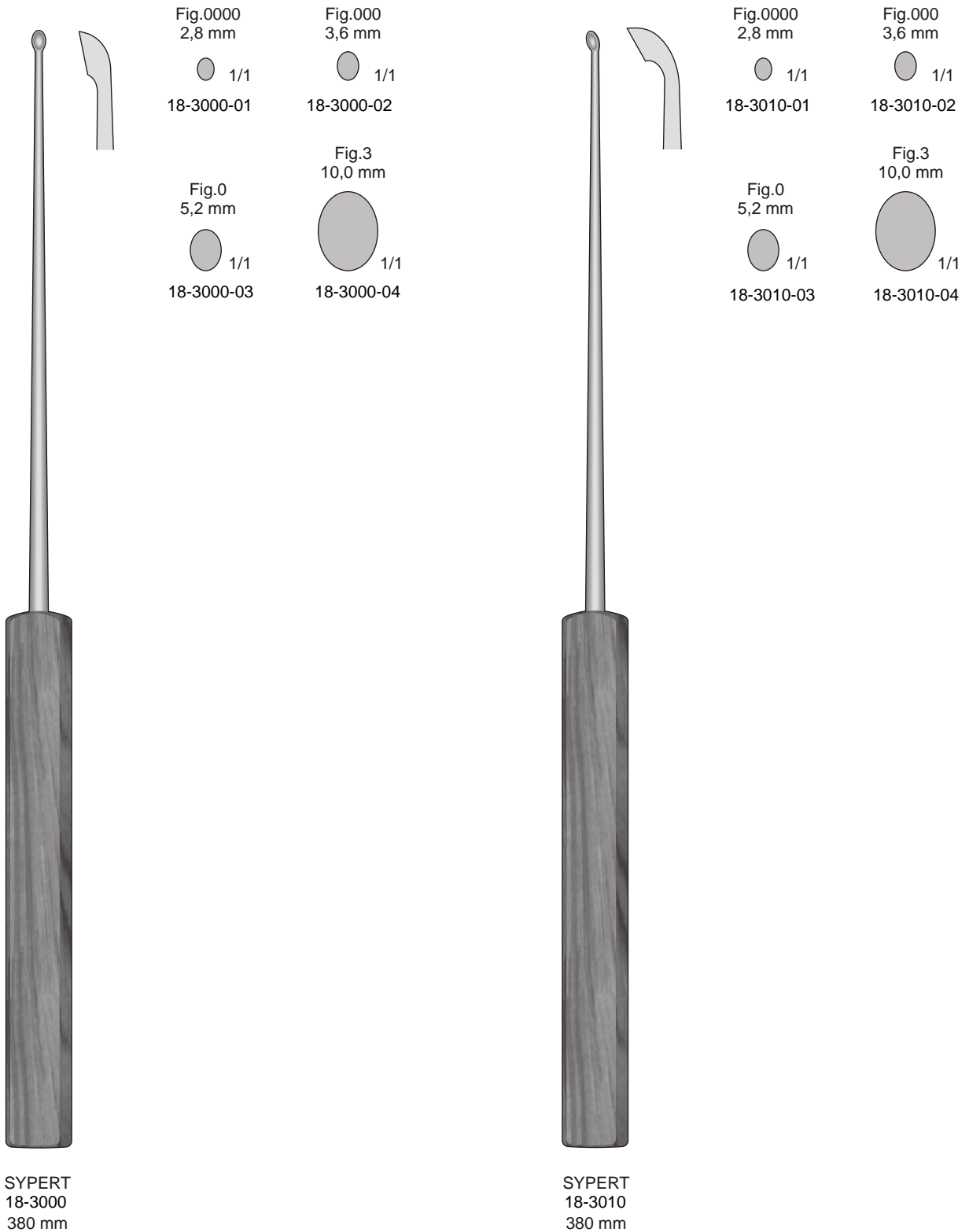
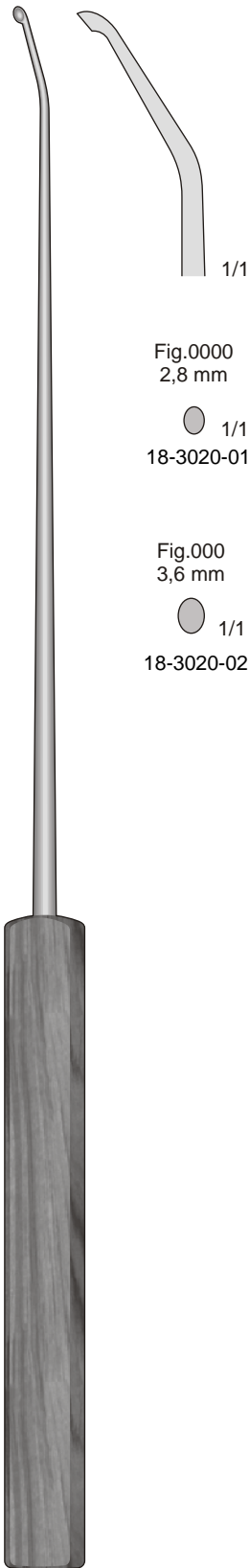

Fig.3/0 2,8 mm  1/1 18-2990-01	Fig.2/0 3,3 mm  1/1 18-2990-02	Fig.0 3,6 mm  1/1 18-2990-03
Fig.1 4,3 mm  1/1 18-2990-04	Fig.2 4,8 mm  1/1 18-2990-05	Fig.3 5,6 mm  1/1 18-2990-06
Fig.4 6,0 mm  1/1 18-2990-07	Fig.5 6,7 mm  1/1 18-2990-08	Fig.6 8,8 mm  1/1 18-2990-09

Mit Ferrozellgriff - With Ferrozell handle
Con manico Ferrozell - Con mango de Ferrozell
Avec poignée en Ferrozell



Mit Ferrozellgriff - With Ferrozell handle
Con manico Ferrozell - Con mango de Ferrozell
Avec poignée en Ferrozell



SYPERT
18-3020
420 mm

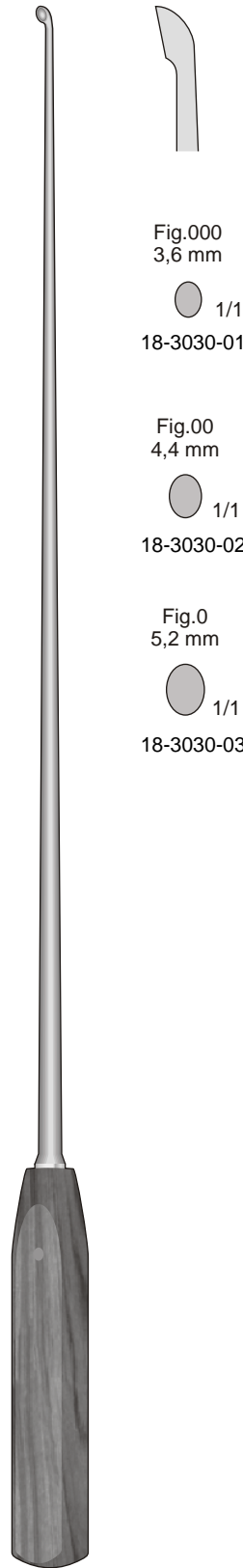

18-3030
410 mm

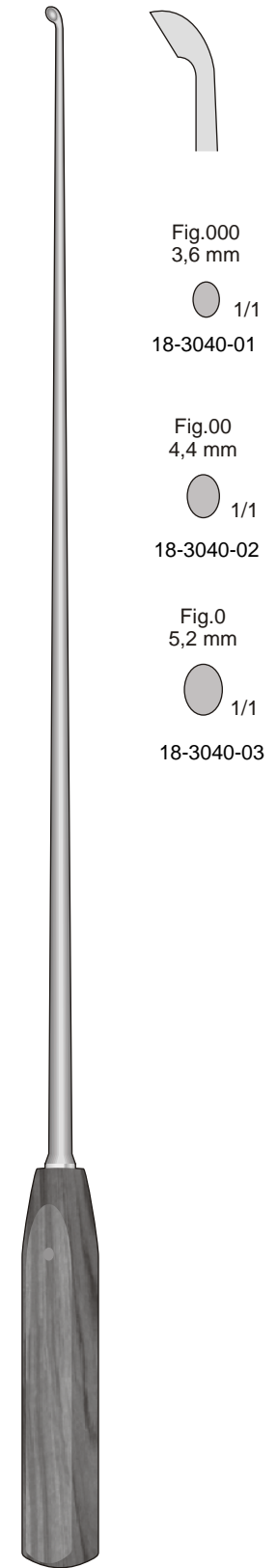

18-3040
410 mm

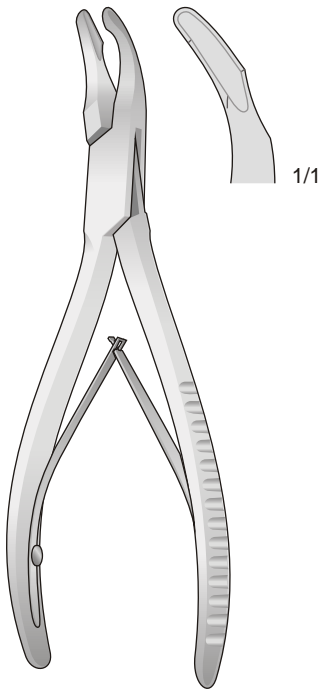

CLEVELAND
18-3050-14 140 mm
18-3050-17 170 mm

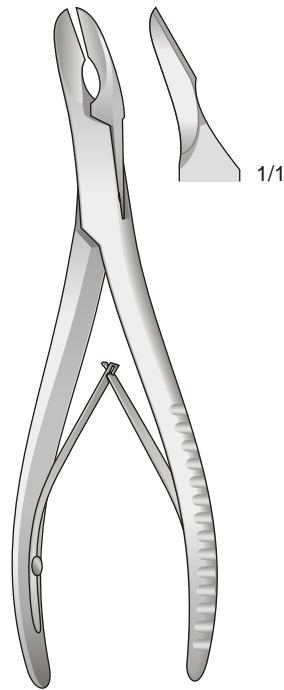

CLEVELAND
18-3060-15 150 mm
18-3060-17 170 mm

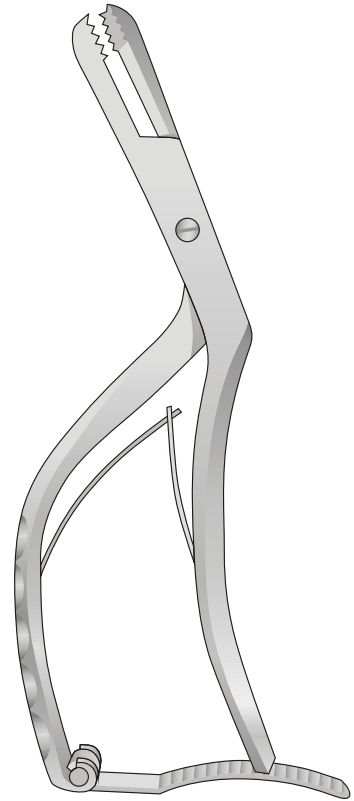

18-3070-20
200 mm

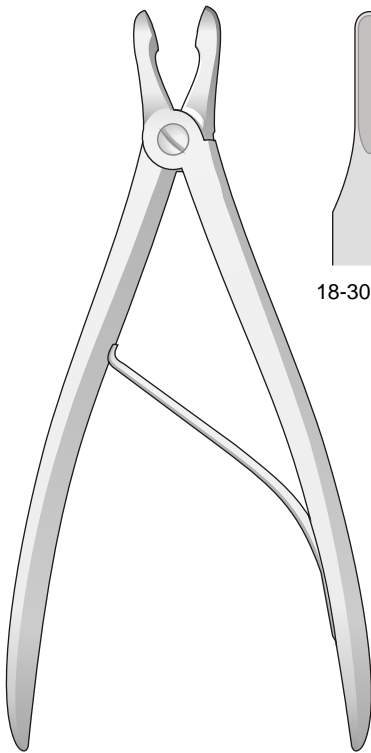

CUSHING
18-3080
190 mm

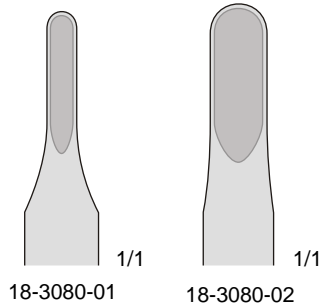

18-3080-01 1/1

18-3080-02 1/1

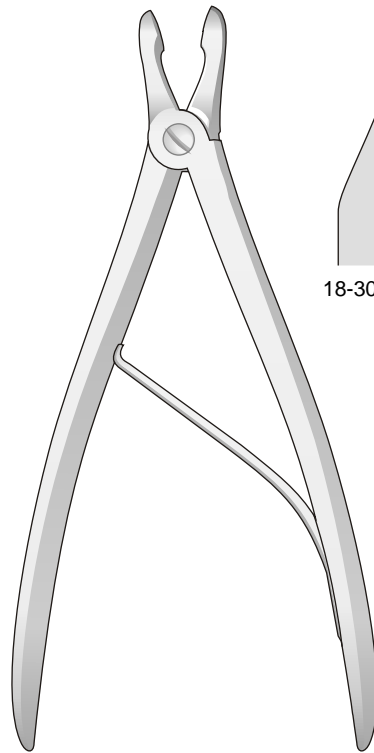

CUSHING
18-3090
190 mm

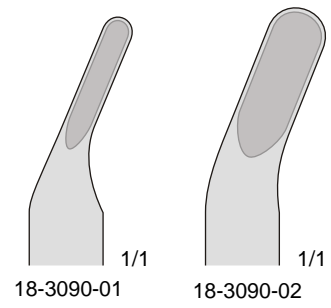

18-3090-01 1/1

18-3090-02 1/1

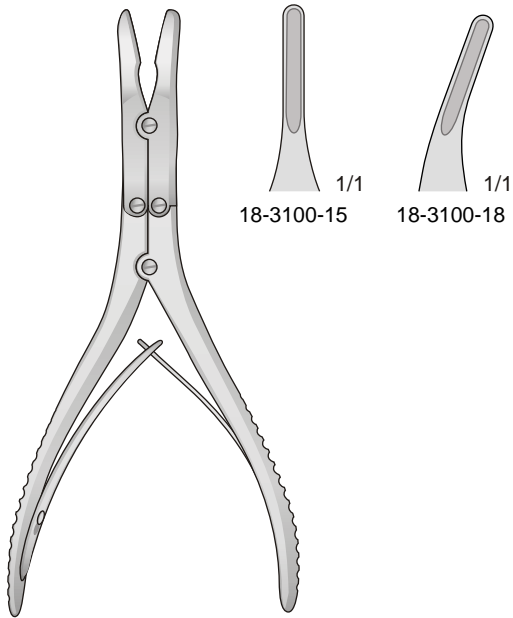

RUSKIN
18-3100
150 mm

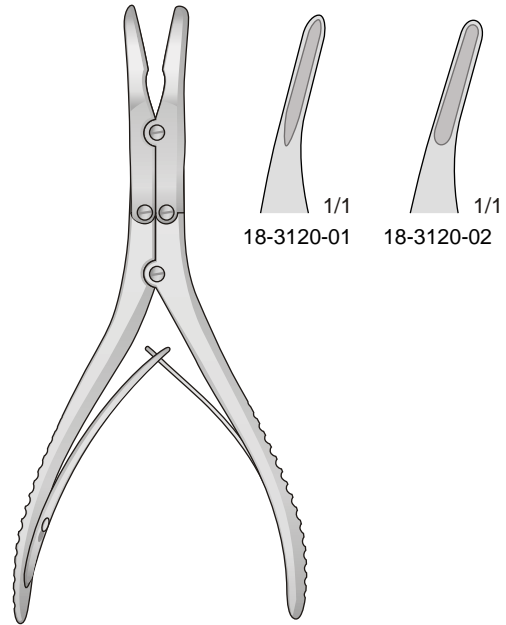

KLEINERT-KUTZ
18-3120
155 mm

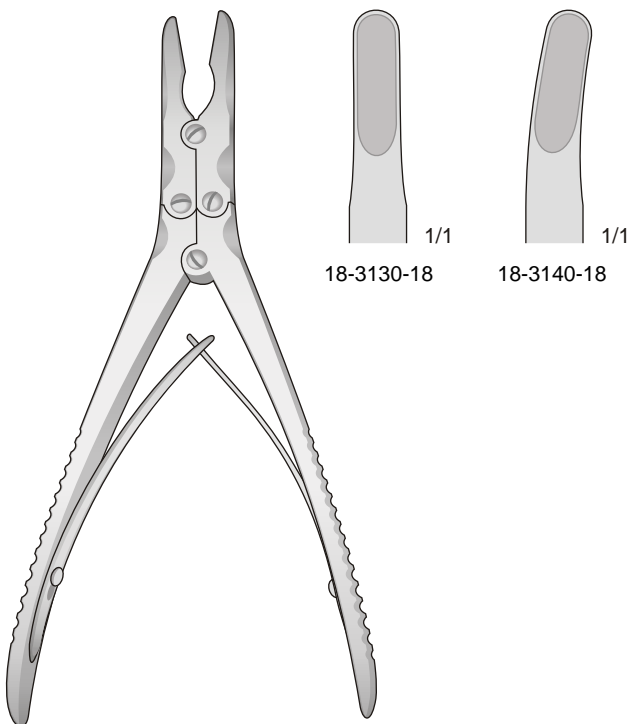

RUSKIN
18-3130
185 mm

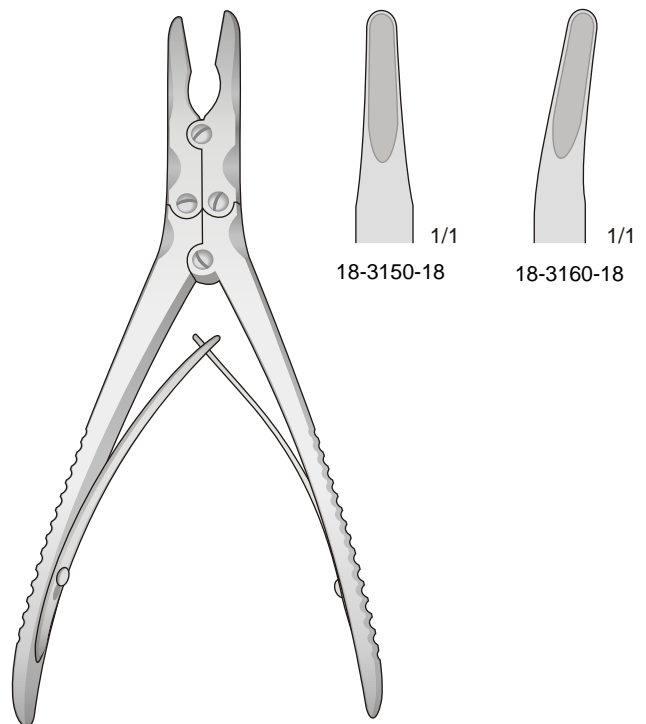

RUSKIN
18-3150
185 mm

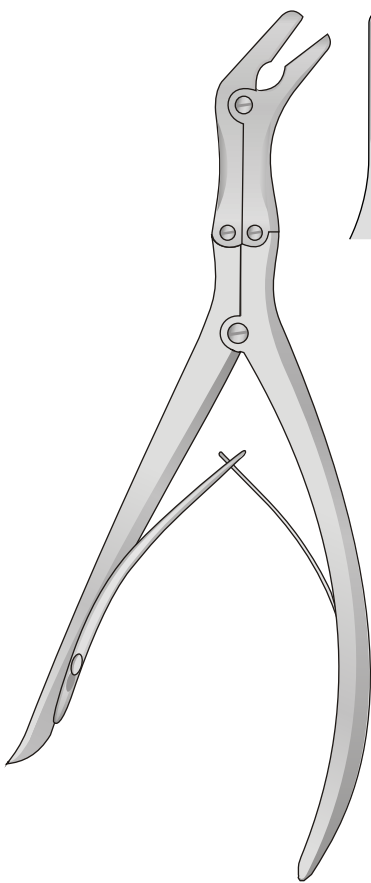

LEKSELL
18-3170-25
250 mm

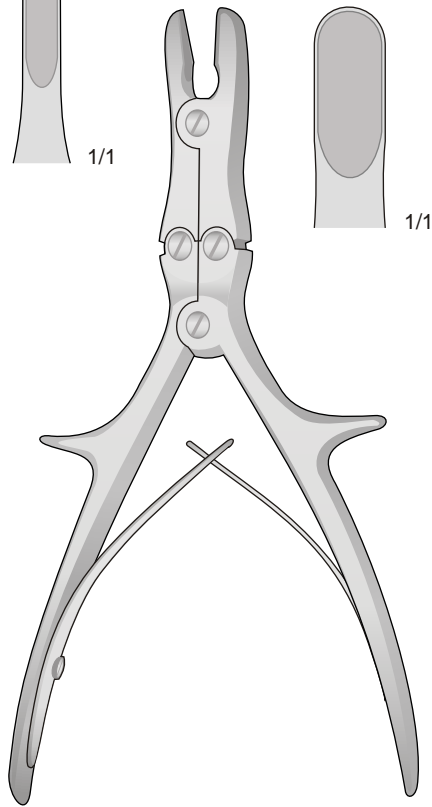

LUER-STILLE
18-3180-22
220 mm

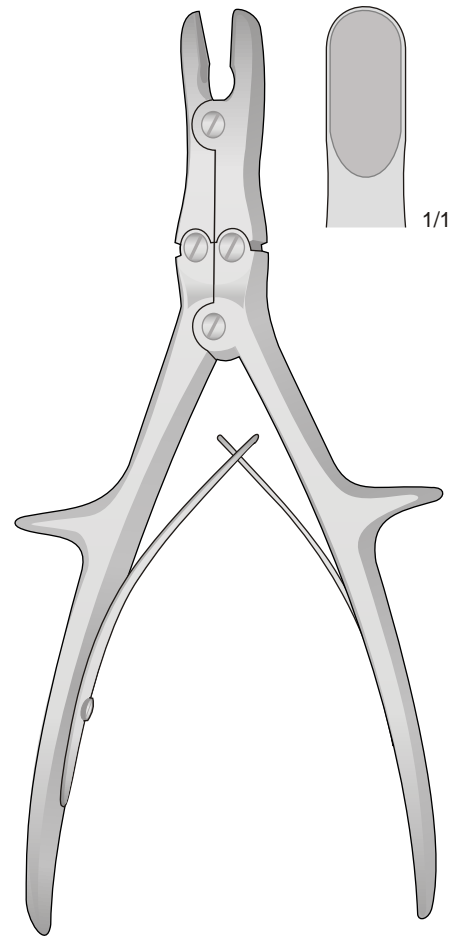

LUER-STILLE
18-3180-26
260 mm

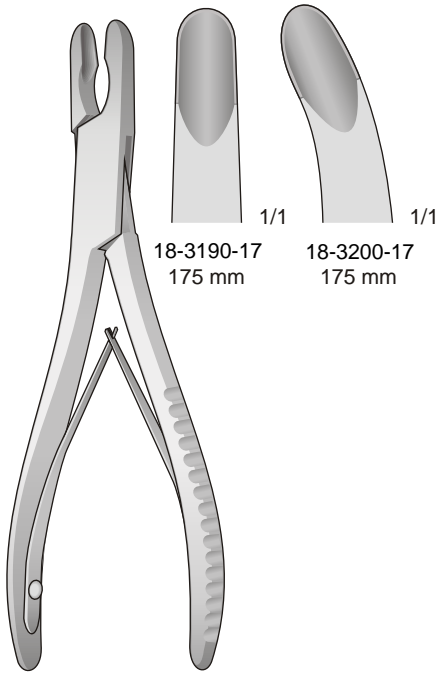

LUER
18-3190/3200
175 mm

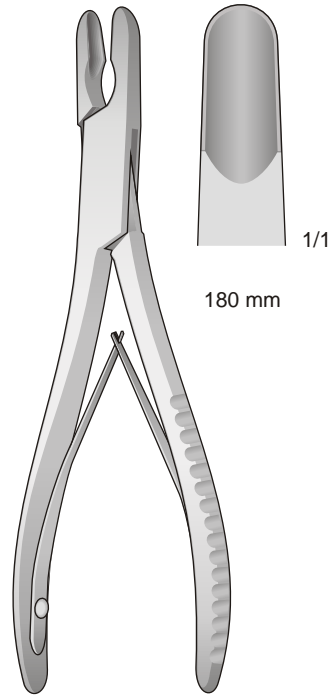

LUER
18-3210-18
180 mm

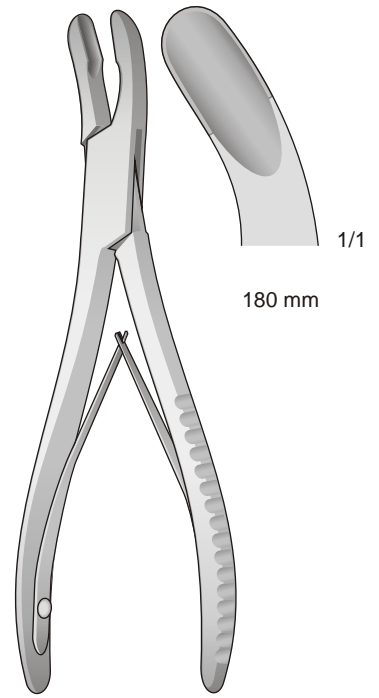

LUER
18-3220-18
180 mm

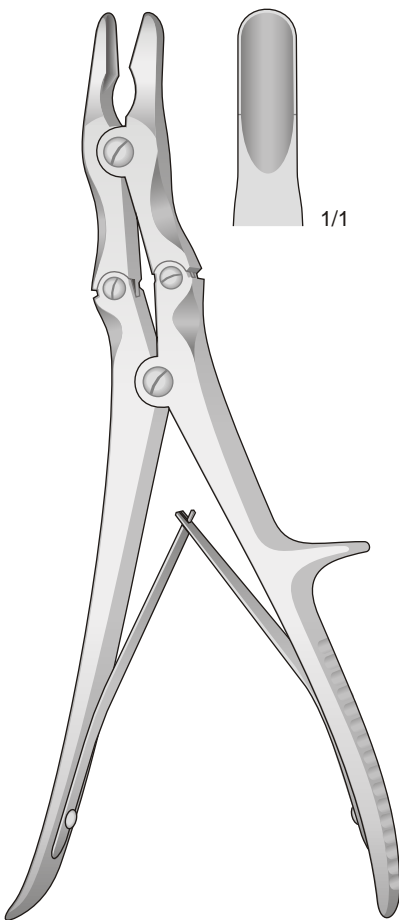

LEKSELL-STILLE
18-3230-24
240 mm

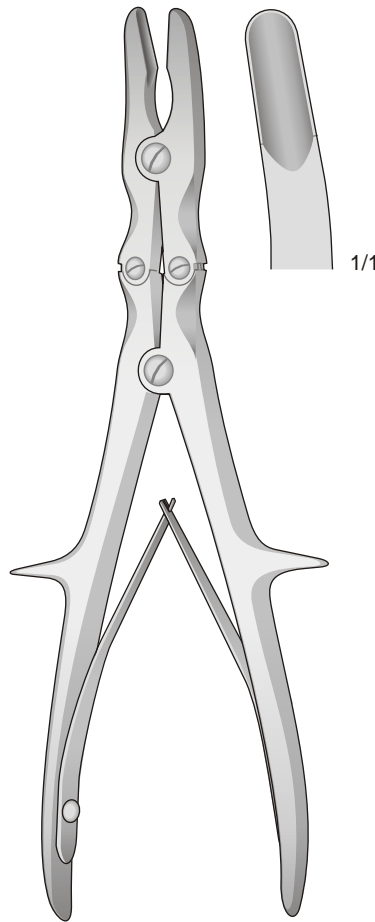

STILLE-RUSKIN
18-3240-24
240 mm

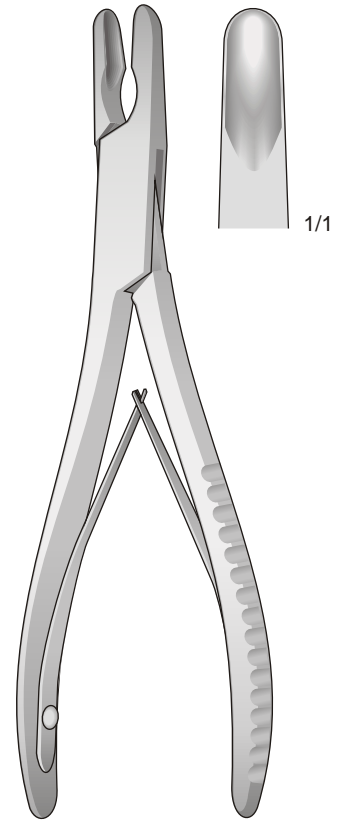

ADSON
18-3250-21
210 mm

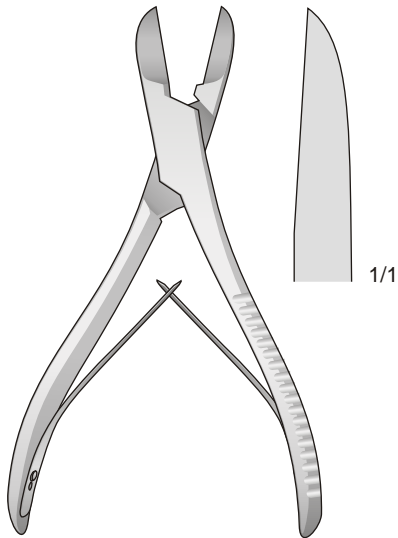

LISTON
18-3260-14
140 mm

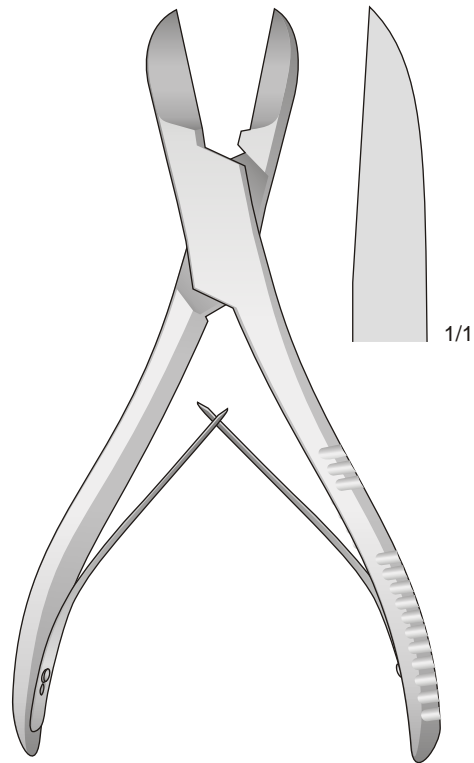

LISTON
18-3260-20
200 mm



18-3270-27
275 mm

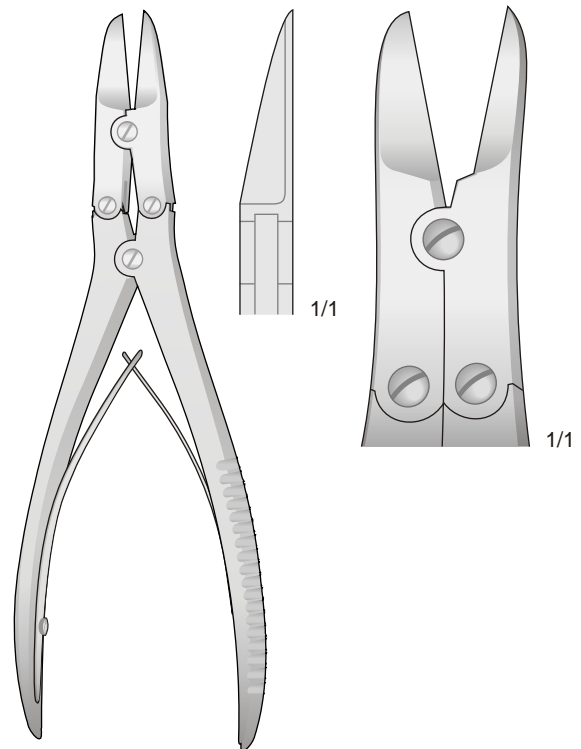

RUSKIN-LISTON
18-3280-19
190 mm

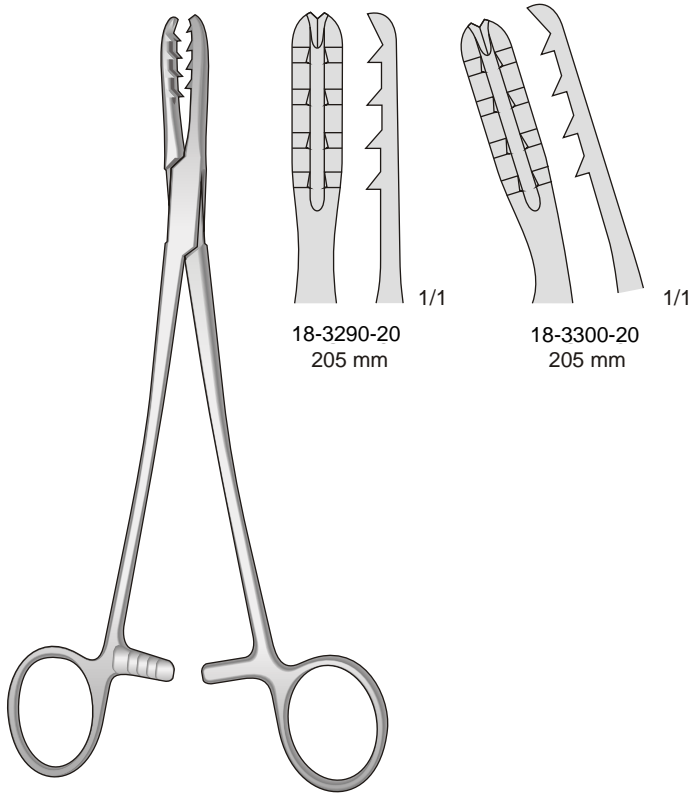

18-3290-20
205 mm

18-3300-20
205 mm

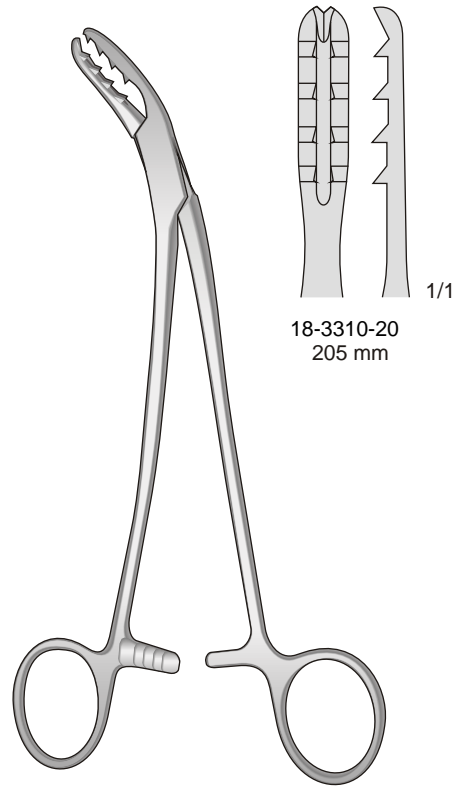

18-3310-20
205 mm

BIRCHER-GANSKE
18-3290
205 mm

BIRCHER-GANSKE
18-3310
200 mm

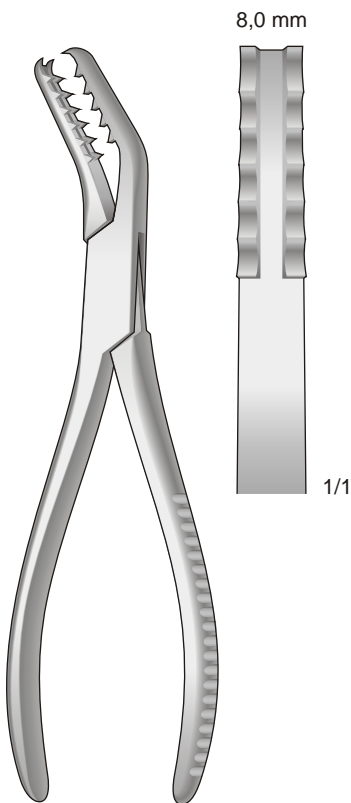

SEMB
18-3320-19
190 mm

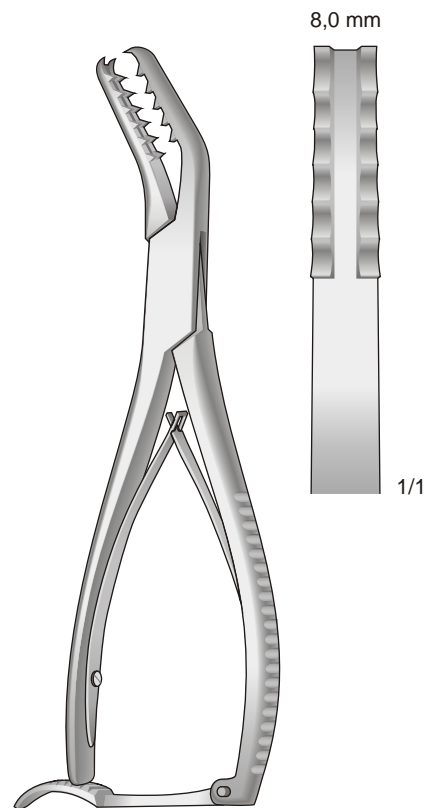

SEMB
18-3330-19
190 mm

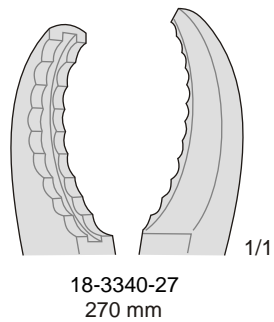
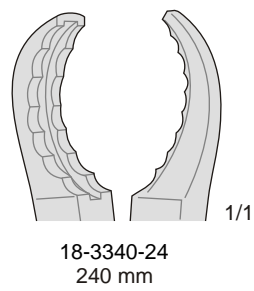
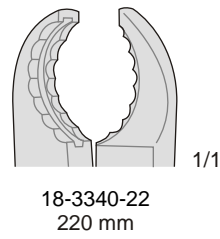
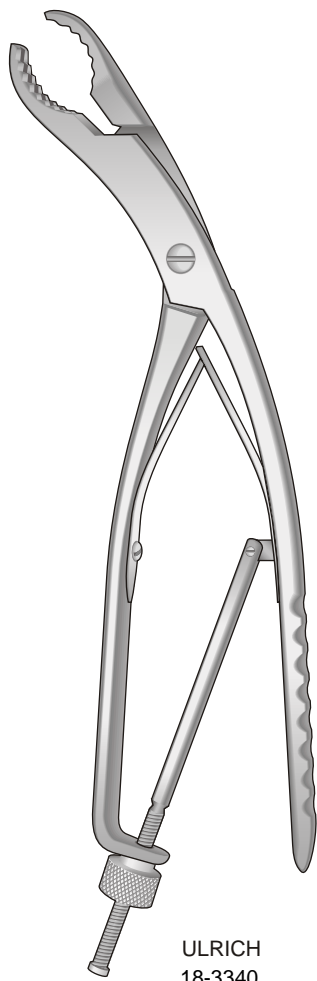
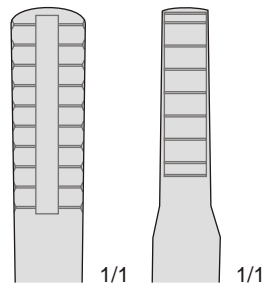
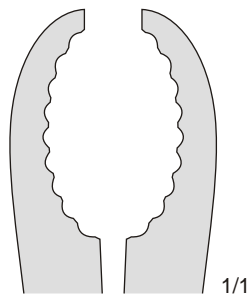

Ersatz für
Replacement for
Ricambio per
Repuesto para
18-3350-01

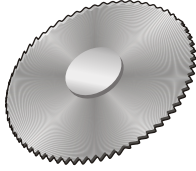

Von Kirschner-Drähten Ø 6 mm
For Kirschner wires Ø 6 mm
Per chiodi Kirschner Ø 6 mm

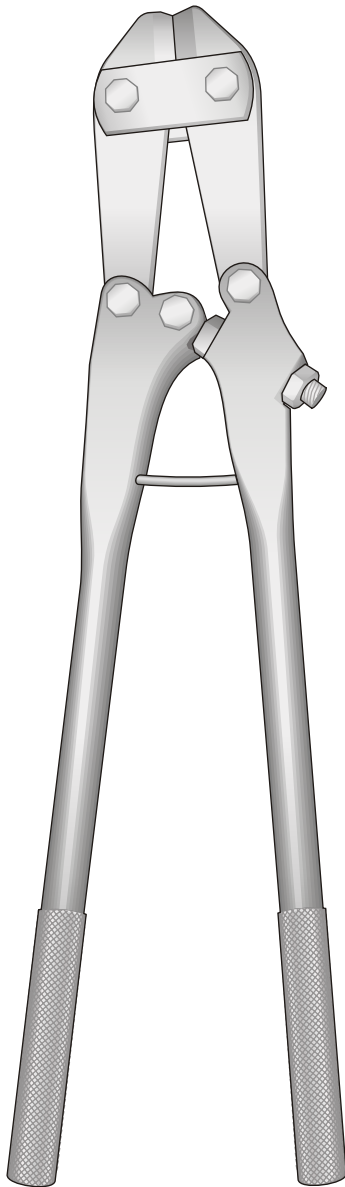

18-3350-45
450 mm

Von Kirschner-Drähten Ø 6 mm
For Kirschner wires Ø 6 mm
Per chiodi Kirschner Ø 6 mm

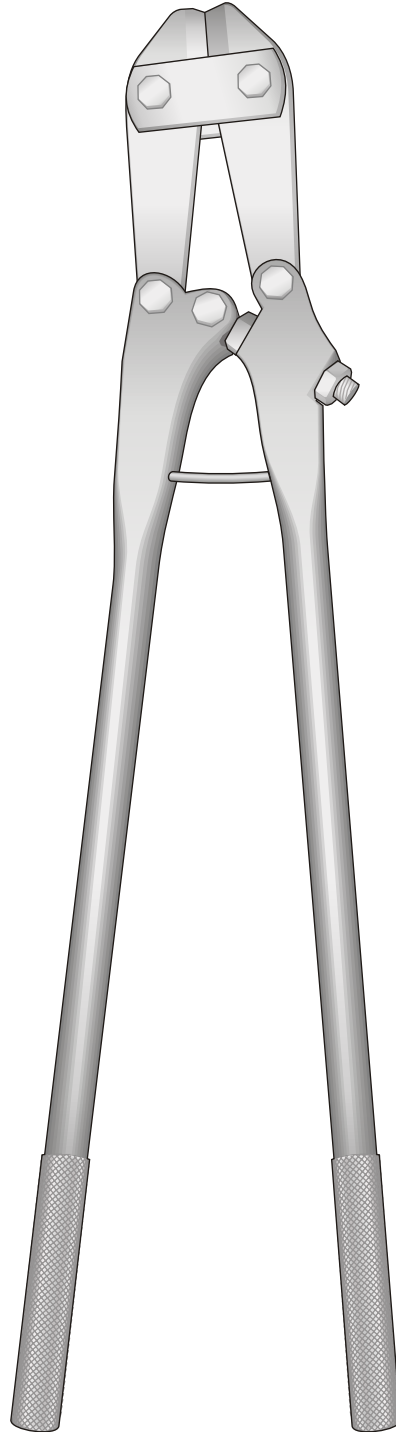

18-3350-56
560 mm

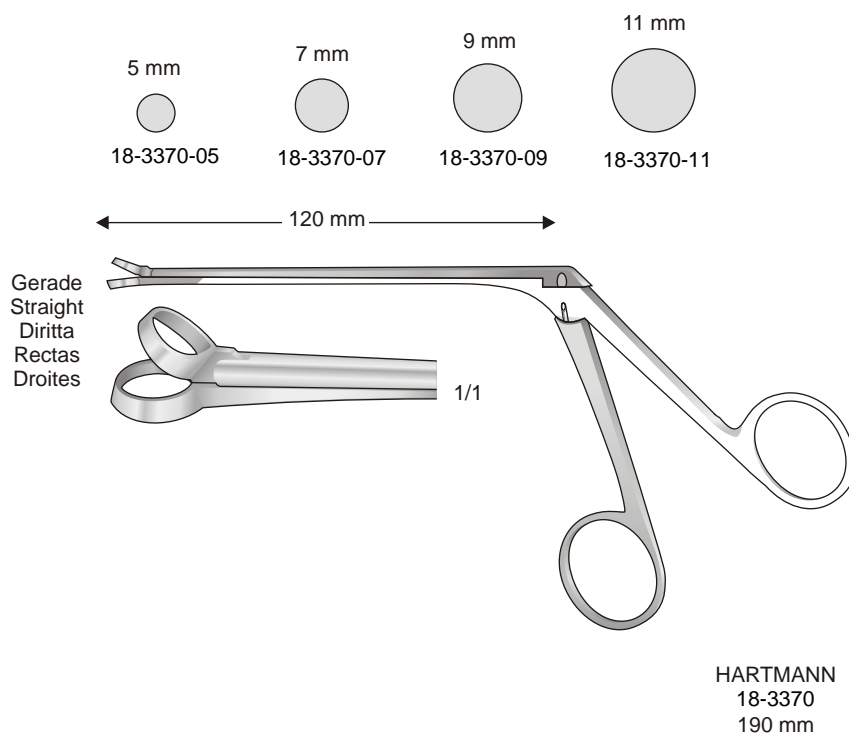
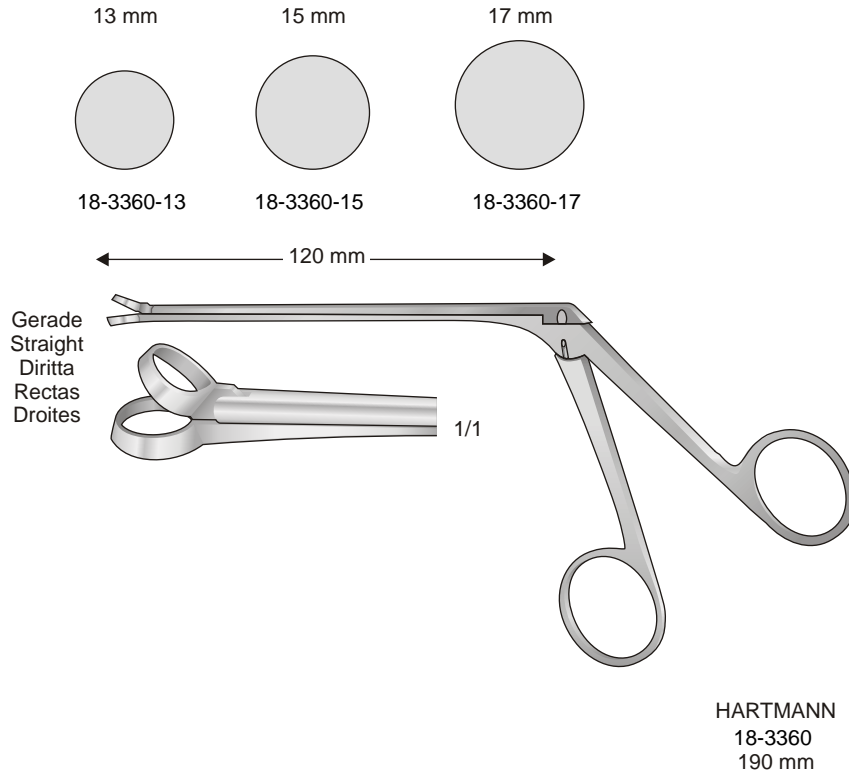

Sehnenschäler
Tendon Stripper
Enucleatore per tendini
Enucleador de tendones
Décolleurs de tendons

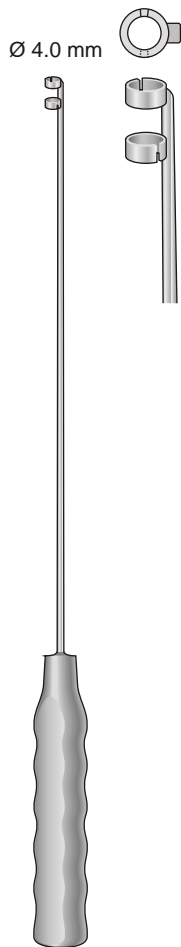

FISCHER
18-3380-31
310 mm



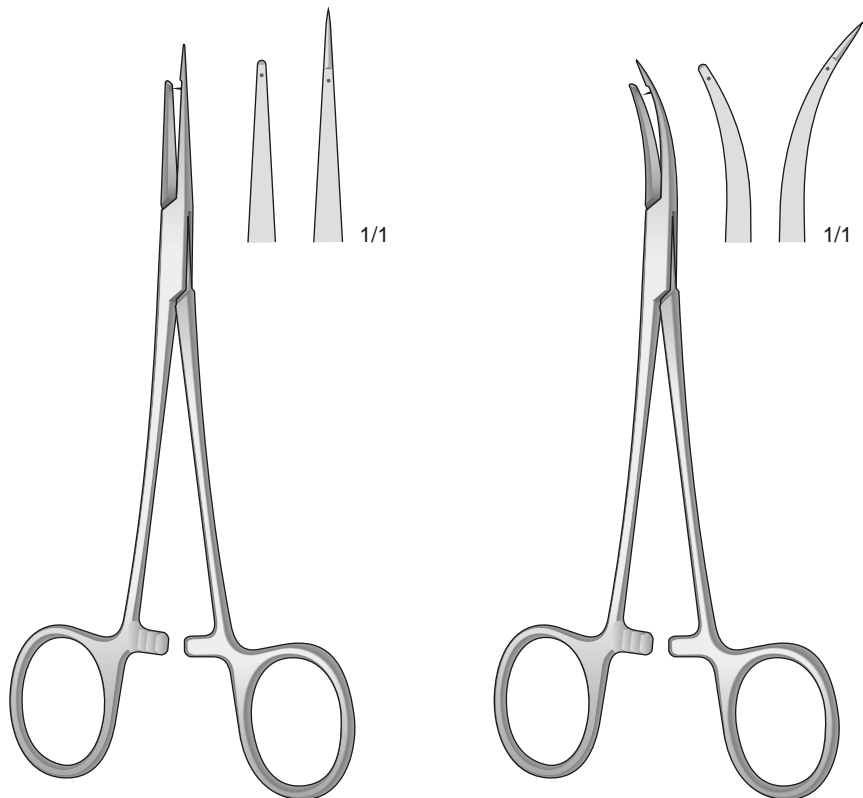









Sehneneinflechtklemmen - Tendon Interlacing Forceps
Pinze per intrecciare tendini - Pinzas para entrelazar tendones
Pincas pour entrelacer les tendons



18-3390-15
150 mm

18-3400-15
150 mm

Rohrschaft. Mikro-Fazangchen - Micro ear forceps with tubular shaft

Mikro-Loffelzangchen Micro cup shaped forceps Micro pinze a cucchiaino		Mikro-Scheren Micro scissors Micro forbici	
0,9 x 1,0 mm ○ Oval Ovale Ovales		18-3410-01 Gerade - Straight Diritta - Recta Droit	 BELLUCCI 18-3410-08 Gerade Straight Diritta Recta Droit
0,9 x 1,0 mm ○ Oval Ovale Ovales		18-3410-02 Nach Oben Gebogen Curved up Curva in alto	 BELLUCCI 18-3410-09 Nach Oben Gebogen Curved up Curva in alto
0,8 x 1,3 mm ○ Oval Ovale Ovales		WULLSTEIN 18-3410-03 Gerade - Straight Diritta - Recta Droit	 BELLUCCI 18-3410-10 Links Gebogen Curved to left Curva a sinistra Curvas a la izquierda Courbes  gauche
0,8 x 1,3 mm ○ Oval Ovale Ovales		WULLSTEIN 18-3410-04 Links Gebogen - Curved to left Curva a sinistra - Curvas a la izquierda Courbes  gauche	 BELLUCCI 18-3410-11 Rechts Gebogen Curved to right Curva a destra Curvas a la derecha Courbes  droite
0,8 x 1,3 mm ○ Oval Ovale Ovales		WULLSTEIN 18-3410-05 Rechts Gebogen - Curved to right Curva a destra - Curvas a la derecha Courbes  droite	 BELLUCCI 18-3410-12 Orizzontale
1,0 mm ○ Rund Round Tonda		WULLSTEIN 18-3410-06 Gerade - Straight Diritta - Recta Droit	
1,7 x 2,5 mm ○ Oval Ovale Ovales		WULLSTEIN 18-3410-07 Gerade - Straight Diritta - Recta Droit	

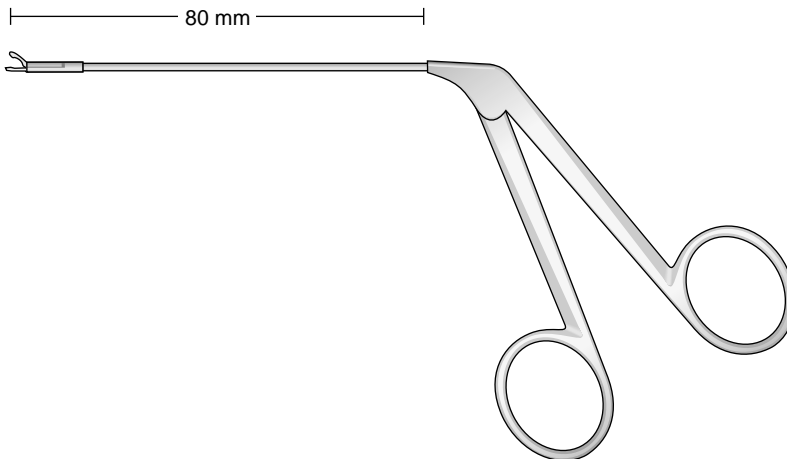

18-3410
80 mm

0,6 x 0,5 mm



18-3420-01
Gerade
Straight
Diritta
Recta
Droit

0,9 x 1,1 mm



18-3420-05
Gerade
Straight
Diritta
Recta
Droit

0,6 x 0,5 mm



18-3420-02
Links Gebogen
Curved to left
Curva a sinistra
Curvas a la izquierda
Courbes  gauche

0,9 x 1,1 mm



18-3420-06
Links Gebogen
Curved to left
Curva a sinistra
Curvas a la izquierda
Courbes  gauche

0,6 x 0,5 mm



18-3420-03
Rechts Gebogen
Curved to right
Curva a destra
Curvas a la derecha
Courbes  droite

0,9 x 1,1 mm



18-3420-07
Rechts Gebogen
Curved to right
Curva a destra
Curvas a la derecha
Courbes  droite

0,6 x 0,5 mm



18-3420-04
Nach Oben Gebogen
Curved up
Curva in alto

0,9 x 1,1 mm



18-3420-08
Nach Oben Gebogen
Curved up
Curva in alto

0,9 x 1,1 mm



18-3420-09
Nach Unten Gebogen
Curved down
Curva in basso

Schaft zerlegbar
Dismantable shaft
Asta smontabile
Vstago desmontable
Tige dmontable

80 mm

Superfein
Extremely delicate
Modello super fine
Superfina
Modle superfin

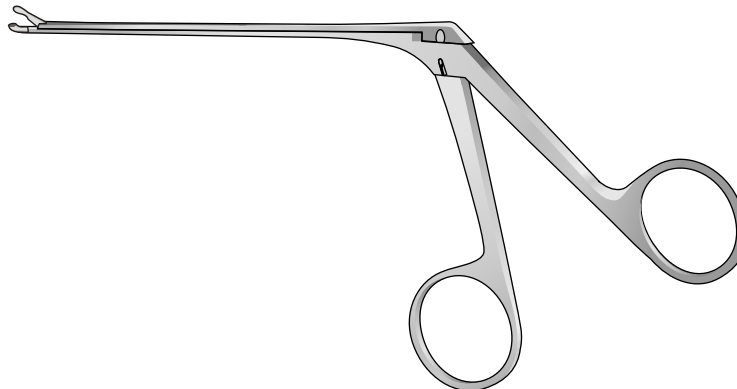

18-3420
80 mm

6,0 x 0,8 mm



SCHUKNECHT

18-3430-01
Gerade
Straight
Diritta
Recta
Droit

4,0 x 0,5 mm

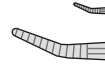

18-3430-05
Rechts Gebogen
Curved to right
Curva a destra
Curvas a la derecha
Courbes à droite

5,0 x 0,8 mm



GREVEN
18-3430-02
Gerade
Straight
Diritta
Recta
Droit

4,0 x 0,5 mm

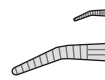

18-3430-06
Links Gebogen
Curved to left
Curva a sinistra
Curvas a la izquierda
Courbes à gauche

4,0 x 0,5 mm



18-3430-03
Gerade
Straight
Diritta
Recta
Droit

4,0 x 0,5 mm



18-3430-07
Nach Oben Gebogen
Curved up
Curva in alto

4,0 x 0,5 mm



18-3430-04
Glattes Maul
Smooth jaws
Morso liscio
Mandibula lisa
Mors lisses

4,0 x 0,5 mm

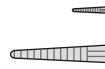

18-3430-08
Nach Unten Gebogen
Curved down
Curva in basso

Schaft zerlegbar
Dismantable shaft
Asta smontabile
Vástago desmontable
Tige démontable

Superfein
Extremely delicate
Modello super fine
Superfina
Modèle superfin

80 mm

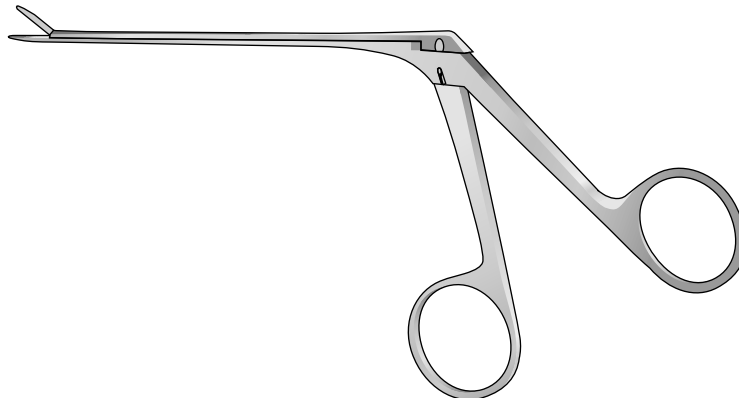

18-3430
80 mm

Rohrschaft. Mikro-Fazangchen
Micro ear forceps with tubular shaft

0,8 x 3,5 mm



18-3440-01
Gerade
Straight
Diritta
Recta
Droit

0,8 x 3,5 mm



18-3440-04
65° Nach Oben Gebogen
Curved up 65°
Curva in alto 65°

1,0 x 5,0 mm



18-3440-02
Gerade
Straight
Diritta
Recta
Droit

0,8 x 3,5 mm



18-3440-05
45° Nach Unter Gebogen
Curved down 45°
Curva in basso 45°

1,5 x 6,0 mm



18-3440-03
Gerade
Straight
Diritta
Recta
Droit

1,0 x 5,0 mm



18-3440-06
Links Gebogen
Curved to left
Curva a sinistra
Curvas a la izquierda
Courbes  gauche

1,0 x 5,0 mm



18-3440-07
Rechts Gebogen
Curved to right
Curva a destra
Curvas a la derecha
Courbes  droite

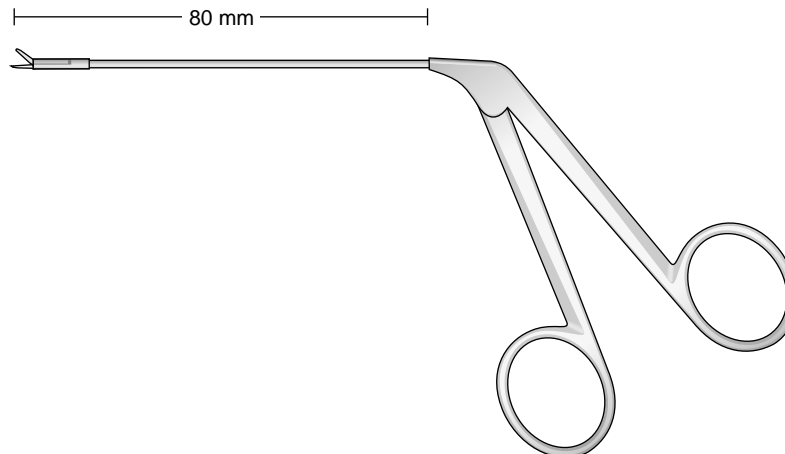

18-3440
80 mm



18-3450-01
Gerade
Straight
Rette
Rectas
Droits



18-3450-02
Gerade, horizontal schneidend
Straight, horizontally cutting
Rette, taglio orizzontale
Rectas, de corte horizontal
Droits, à coupe horizontale



18-3450-03
Nach links gebogen
Curved to left
Curve a sinistra
Acodadas hacia la izquierda
Courbes à gauche



18-3450-04
Nach rechts gebogen
Curved to right
Curve a destra
Acodadas hacia la derecha
Courbes à droite



18-3450-05
Nach oben abgewinkelt
Angled up
Angolate in alto
Angulada hacia arriba
Coudés vers le haut



18-3450-06
Nach unten abgewinkelt
Angled down
Angolate in basso
Angulada hacia abajo
Coudés vers le bas



18-3450-07
Gerefties maul, gerade
Serrated jaws, straight
Morsi zigrinati, retti
Boca estriada, recta
Mors striés, droits

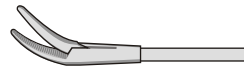

18-3450-08
Gerefties maul, rechts gebogen
Serrated jaws, right
Morsi zigrinati, curvi a destra
Boca estriada, curva a la derecha
Mors striés, courbes à droite



18-3450-09
Gerefties maul, links gebogen
Serrated jaws, left
Morsi zigrinati, curvi a sinistra
Boca estriada, curva a la izquierda
Mors striés, courbes à gauche

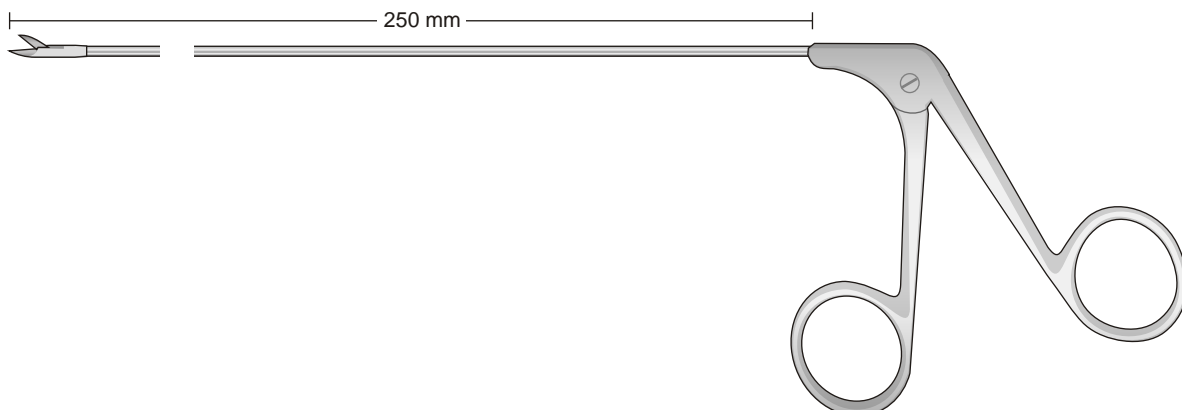

18-3450
250 mm



18-3460-01
Rundes Löffelmaul, gerade
Round cup jaws, straight
Morso a forma di cucchiaio rotondo, retto
Boca redonda en forma de cucharilla, recta
Mors ronds en cuiller, droits



18-3460-02
Rundes Löffelmaul, nach oben
Round cup jaws, up
Morso a forma di cucchiaio rotondo, in alto
Boca redonda en forma de cucharilla, arriba
Mors ronds en cuiller, courbes en haut



18-3460-03
Rundes Löffelmaul, rechts
Round cup jaws, right
Morso a forma di cucchiaio rotondo, destra
Boca redonda en forma de cucharilla, a la derecha
Mors ronds en cuiller, courbes à droite



18-3460-04
Rundes Löffelmaul, links
Round cup jaws, left
Morso a forma di cucchiaio rotondo, sinistra
Boca redonda en forma de cucharilla, a la izquierda
Mors ronds en cuiller, courbes à gauche



18-3460-05
Ovales Löffelmaul, gerade
Oval cup jaws, straight
Morso a forma di cucchiaio ovale, retto
Boca ovalada en forma de cucharilla, recta
Mors ovales en cuiller, droits



18-3460-06
Ovales Löffelmaul, nach oben
Oval cup jaws, up
Morso a forma di cucchiaio ovale, in alto
Boca ovalada en forma de cucharilla, arriba
Mors ovales en cuiller, courbes en haut



18-3460-07
Ovales Löffelmaul, rechts
Oval cup jaws, right
Morso a forma di cucchiaio ovale, destra
Boca ovalada en forma de cucharilla, a la derecha
Mors ovales en cuiller, courbes à droite



18-3460-08
Ovales Löffelmaul, links
Oval cup jaws, left
Morso a forma di cucchiaio ovale, sinistra
Boca ovalada en forma de cucharilla, a la izquierda
Mors ovales en cuiller, courbes à gauche

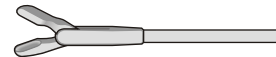

18-3460-09
Ovales Löffelmaul, gerade
Oval cup jaws, straight
Morso a forma di cucchiaio ovale, retto
Boca ovalada en forma de cucharilla, recta
Mors ovales en cuiller, droits



18-3460-10
Maulteile gefenstert
Jaw fenestrated
Morso fenestrato
Boca fenestrada
Mors ajourés

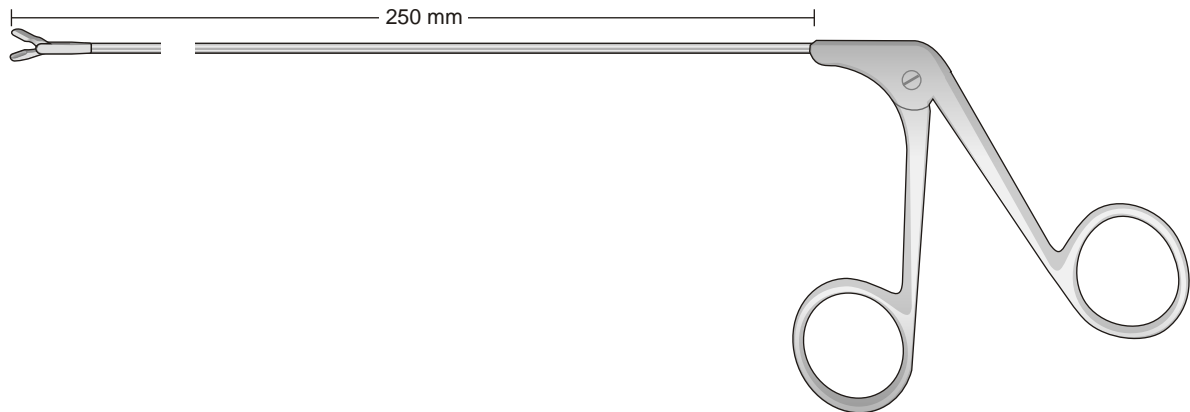

18-3460
250 mm

Gerade
Stright
Diritta
Rectas
Droites

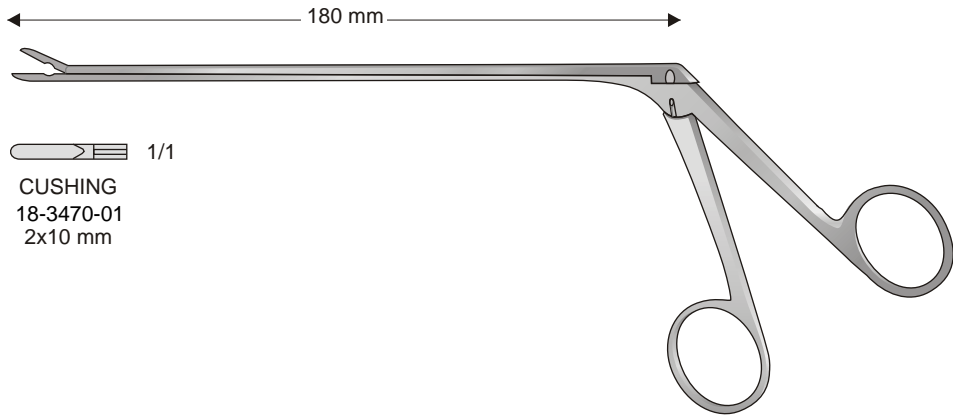

1/1
CUSHING
18-3470-01
2x10 mm

CUSHING
18-3470-01

Aufwärtsgebogen
Top curved
Curva verso l'alto
Curvos
Courbe vers le haut

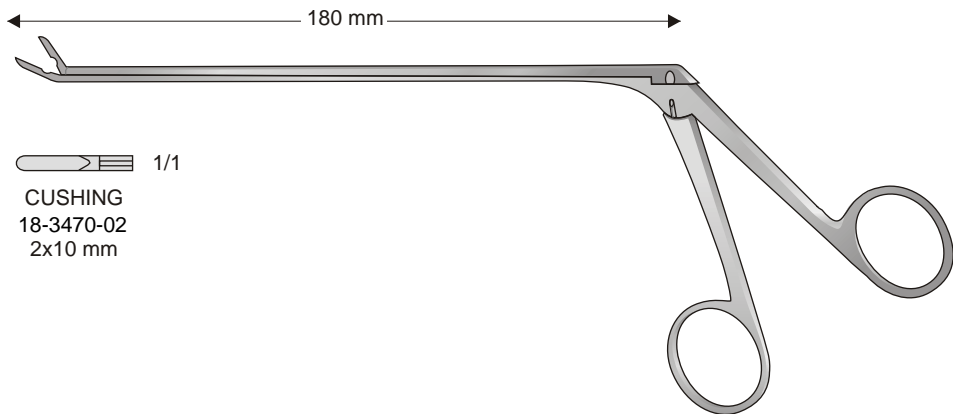

1/1
CUSHING
18-3470-02
2x10 mm

CUSHING
18-3470-02

Abwärts gebogen
Bottom curved
Curva verso il basso
Curvos
Courbe vers le bas

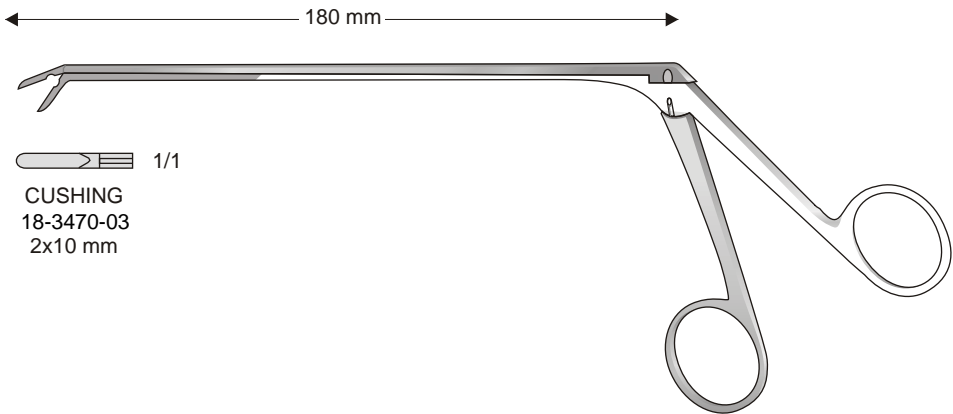

1/1
CUSHING
18-3470-03
2x10 mm

CUSHING
18-3470-03

Katheter-Einführungsinstrumente
Catheter introducing instruments
Strumenti per tendere ed introdurre i cateteri
Instrumentos para introducir catéteres
Mandrin pour introduire les sondes

Ø 1,2 mm

Endospekula für Harnröhre und
Cervix, ohne Sperre
Endospecula for cervix and urethra,
without ratchet

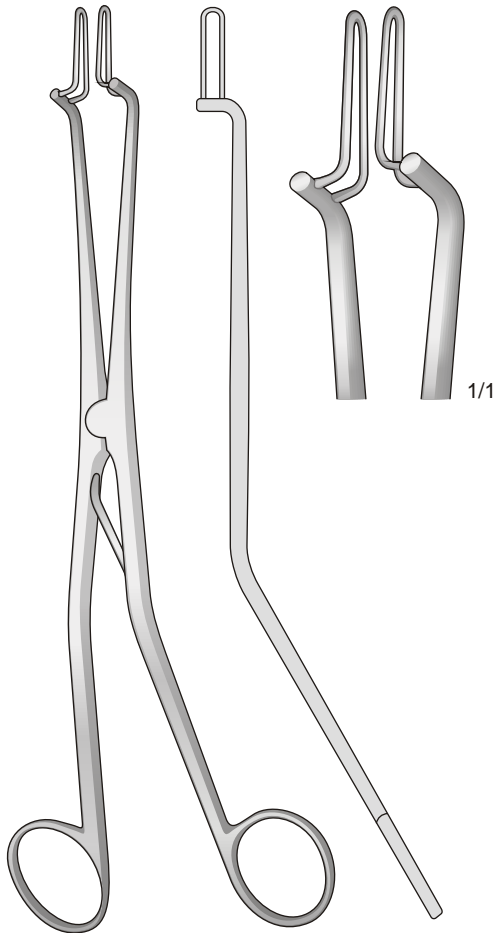

KOGAN
18-3480-01
240 mm

Endospekula für Harnröhre und
Cervix, mit Skalensperre und Fixierschraube
Endospecula for cervix and urethra,
with scale-ratchet and fixing screws
Con cremagliera a scala e vite di fissaggio
Con cremallera graduada y tornillo de fijación
Avec crémaillère à échelle et vis à fixation

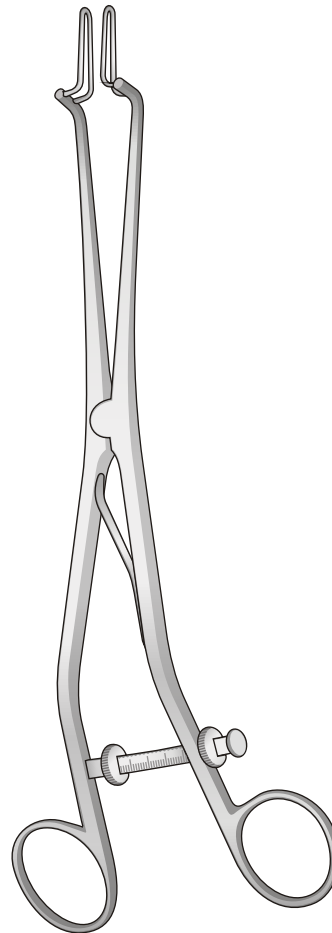

KOGAN
18-3480-02
240 mm

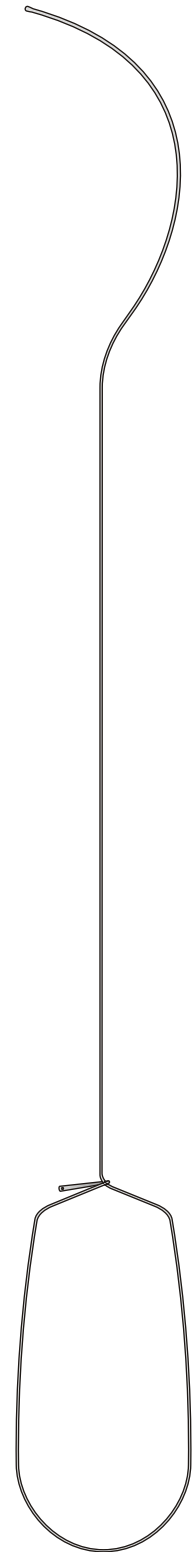

18-3480-42
425 mm

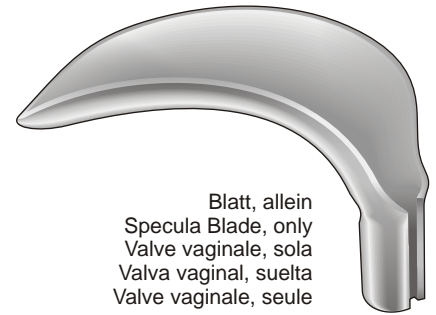
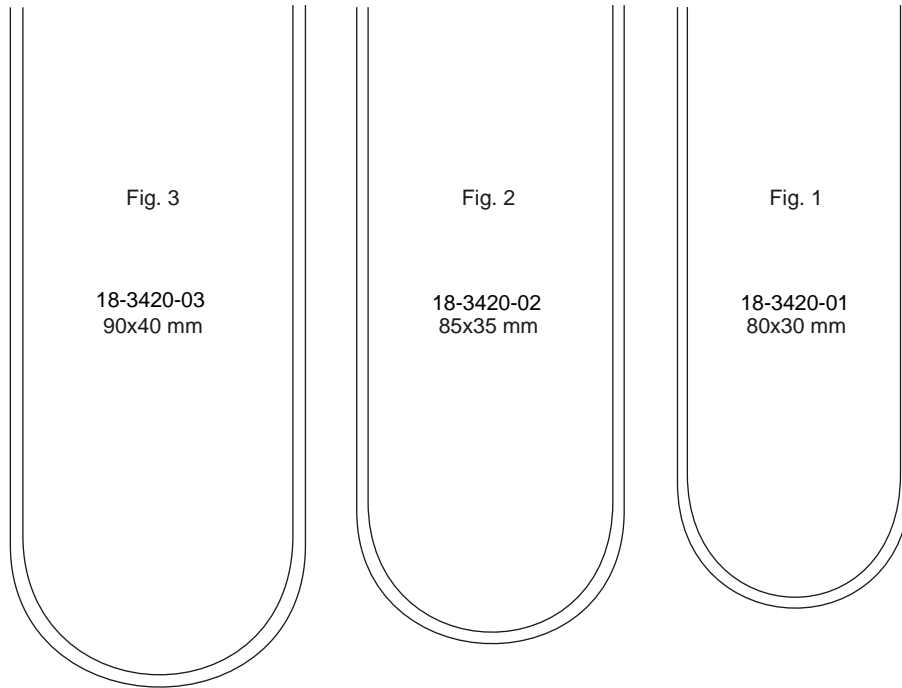

SCHERBAK
18-3420

Blasenhalsperrer
Sounds Bladder
Dilatatore del collo vescicale
Sonda vesicales
Dilatateur pour le col vésical

Biopsiekürette
Uterine Biopsy Curette
Curette per biopsia
Curettes para biopsia
Curettes pour biopsie

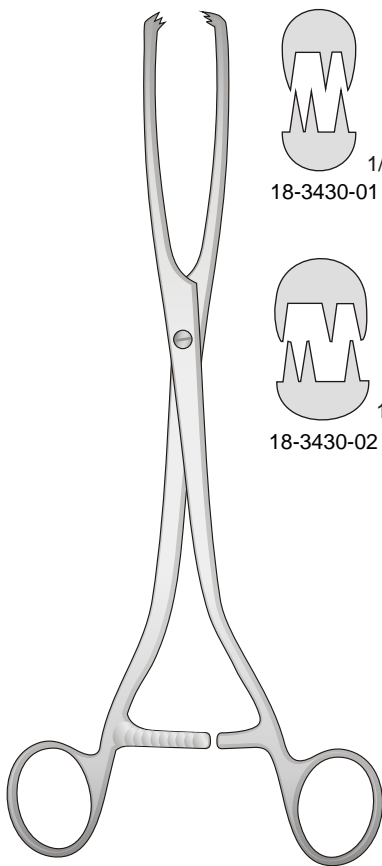

MUSEUX
18-3430
265 mm

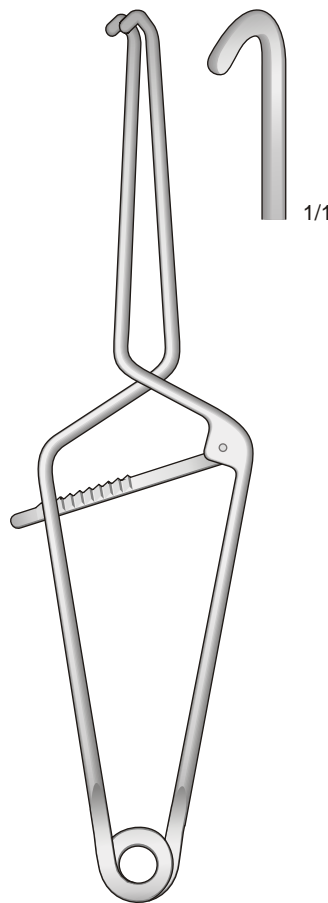

MILLIN
18-3440-28
280 mm

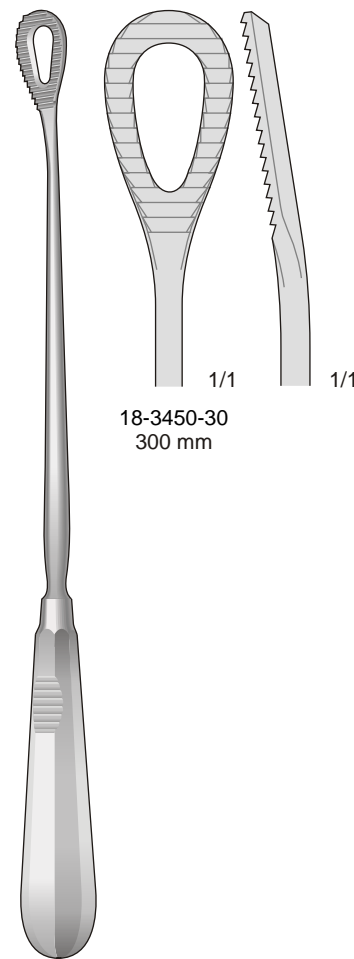

PESTALOZZA
18-3450
300 mm

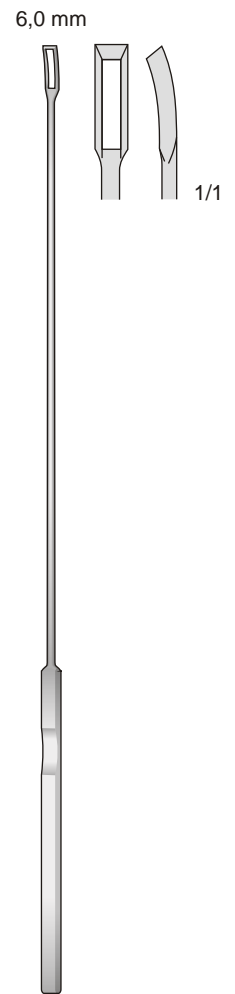

KEVORKIAN
18-3460-30
300 mm

Gewicht zum Vaginalsepekulum
Weight for Vaginal Speculum
Peso per specolo vaginale
Peso para espéculo vaginal
Poids pour spéculum vaginal

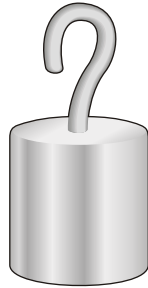

SCHERBAK
18-3500-01 10,5 mm 400 gr
18-3500-02 13 mm 800 gr

Blatt, allein
Specula Blade, only
Valve vaginale, sola
Valva vaginal, suelta
Valve vaginale, seule

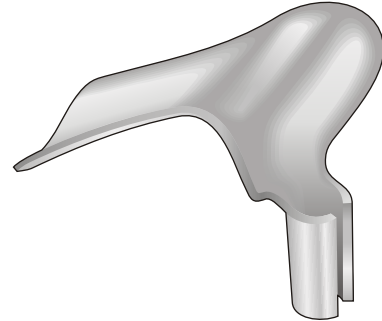

SCHERBAK
18-3490

Griff zum Vaginalsepekulum
Handle for Vaginal Speculum
Manico per specolo vaginale
Mango para espéculo vaginal
Manche pour spéculum vaginal

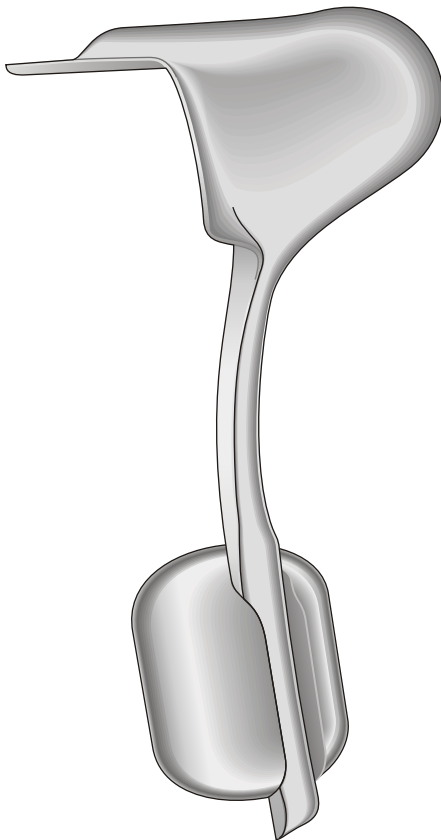

AUVARD
18-3470-23
230 mm

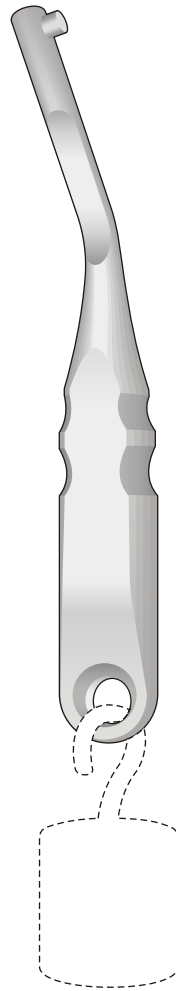

SCHERBAK
18-3480
200 mm

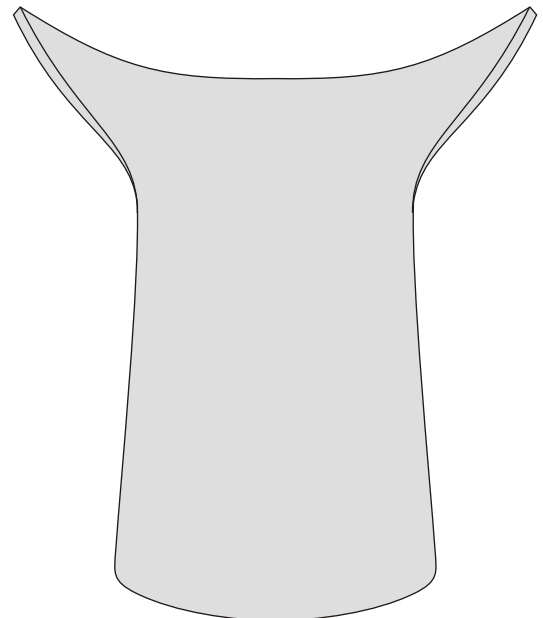

18-3490-01
81x45 - 70 mm

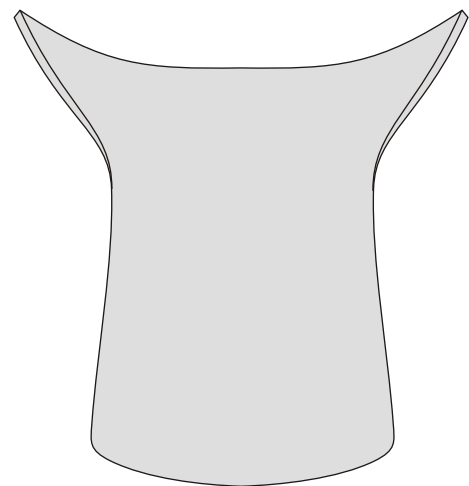

18-3490-02
62x40 - 60 mm

Geschwärzt
Surface Black-finish
Superficie anti-riflesso
Surface noircie



18-3510-01
75 x 20 mm



18-3510-02
100 x 22 mm



18-3510-03
120 x 25 mm

18-3520-14

Komplettset mit 14 Uterusdilatatoren ohne Metalltui
Set con 14 dilatatori uterini senza scatola

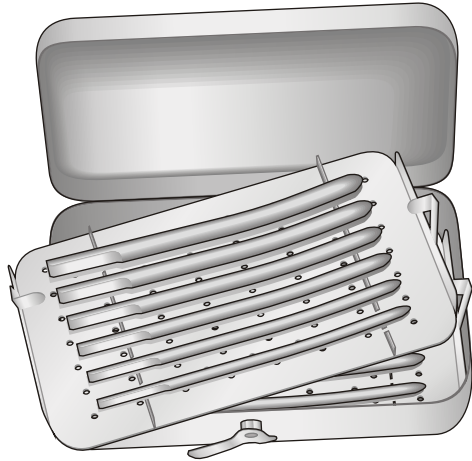

18-3520-26

Komplettset mit 26 Uterusdilatatoren ohne Metalltui
Set con 26 dilatatori uterini senza scatola

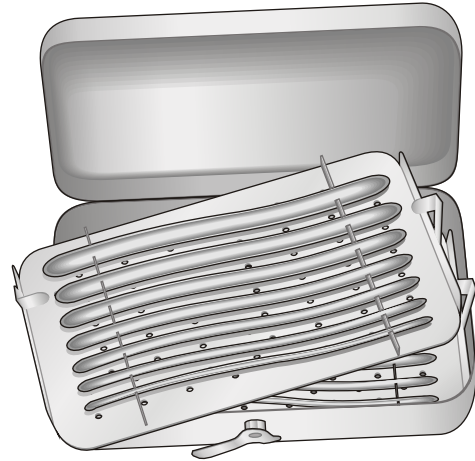

18-3530-14

Metalltui mit 14 Hegar Uterusdilatatoren
Scatola con 14 dilatatori uterini Hegar

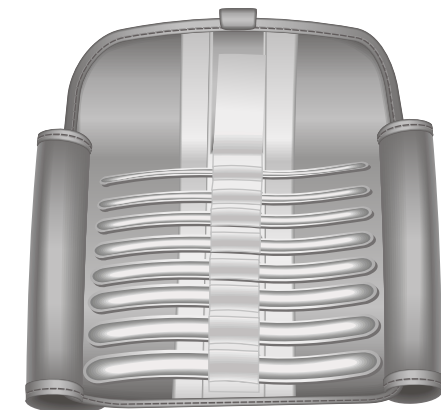

18-3530-13

Metalltui mit 13 Hegar Uterusdilatatoren
Scatola con 13 dilatatori uterini Hegar

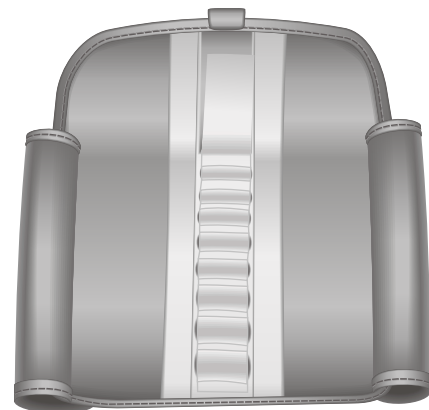

18-3540-08
mit 8 Uterusdilatatoren
con 8 dilatatori uterini

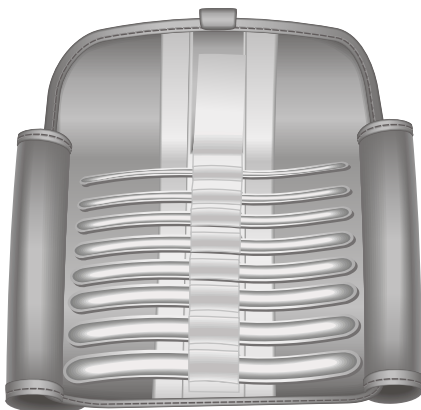

18-3550-08
für 8 Uterusdilatatoren
per 8 dilatatori uterini

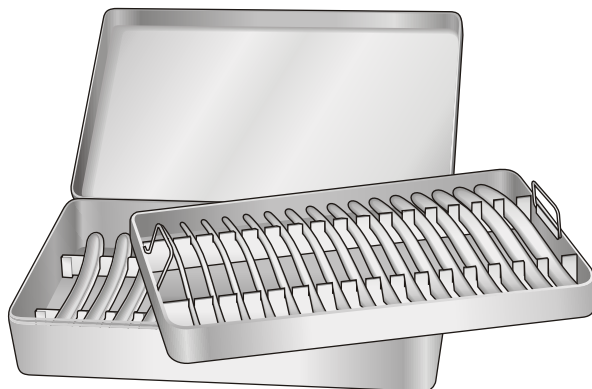
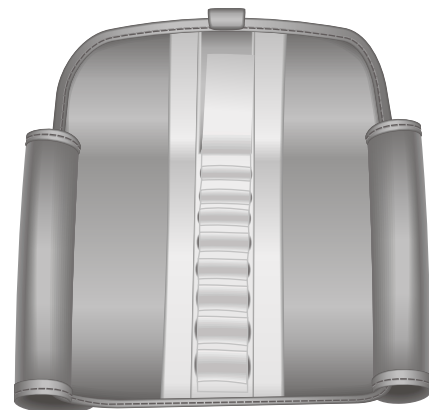

18-3560-26

Metalltui mit 26 Hegar Uterusdilatatoren
Scatola con 26 dilatatori uterini Hegar

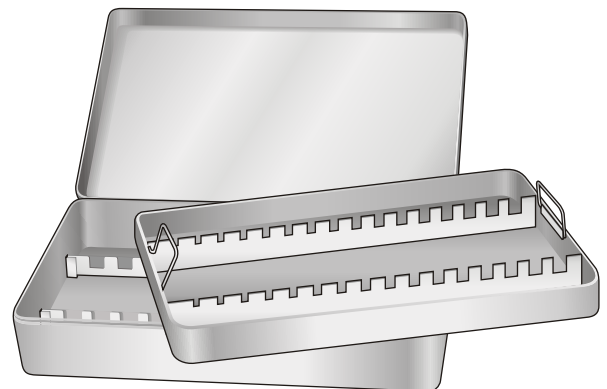

18-3570-26

Metalltui leer für 26 Hegar Uterusdilatatoren
Scatola vuota per 26 dilatatori uterini Hegar

Uterusdepressor
Uterine Depressor
Depressore uterino
Depresor uterino
Dépresseur utérin



BRAUN
18-3590-27
275 mm

Sterilisierzangen zum Fassen und Halten Steriler Instrumente
Sterilizing forceps for picking up and holding of sterile instruments
Pinze per prelevare strumenti sterilizzati
Pinzas para esterilización
Pincas pour instruments stérilisés

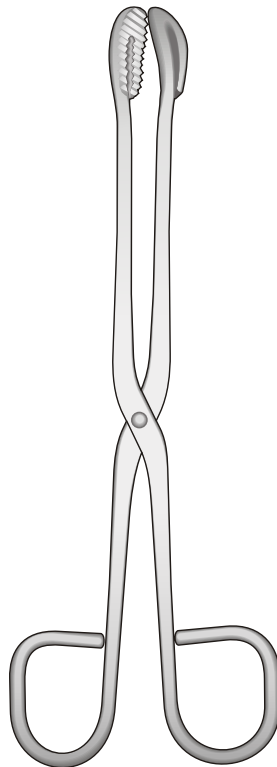

18-3600-20 200 mm
18-3600-30 300 mm

Pinza per rimozione punti metallici

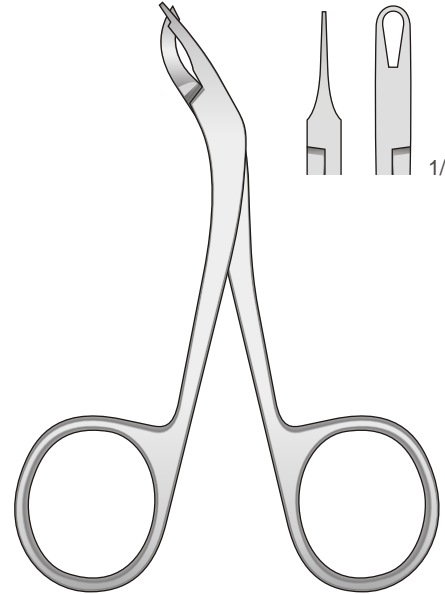

18-3580-11
115 mm

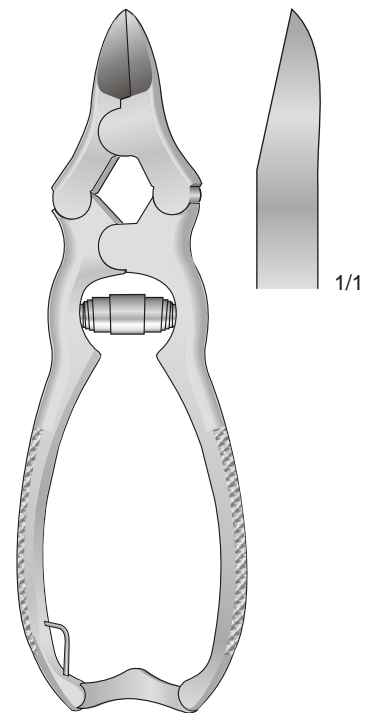

18-3610-15
155 mm

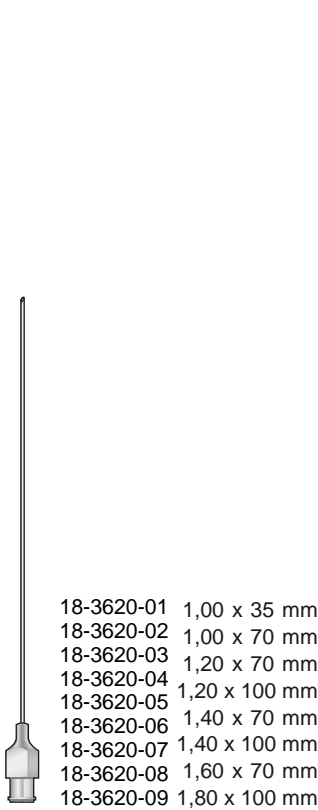

- 18-3620-01 1,00 x 35 mm
- 18-3620-02 1,00 x 70 mm
- 18-3620-03 1,20 x 70 mm
- 18-3620-04 1,20 x 100 mm
- 18-3620-05 1,20 x 100 mm
- 18-3620-06 1,40 x 70 mm
- 18-3620-07 1,40 x 100 mm
- 18-3620-08 1,60 x 70 mm
- 18-3620-09 1,80 x 100 mm

MENGHINI
18-3620



- 18-3630-01 1,40 x 168 mm
- 18-3630-02 1,80 x 168 mm

MENGHINI
18-3630

Saugkanüle, isoliert
mit Saugunterbrecher und Mandrin
Suction cannula, insulated
with finger cut-off and stylet

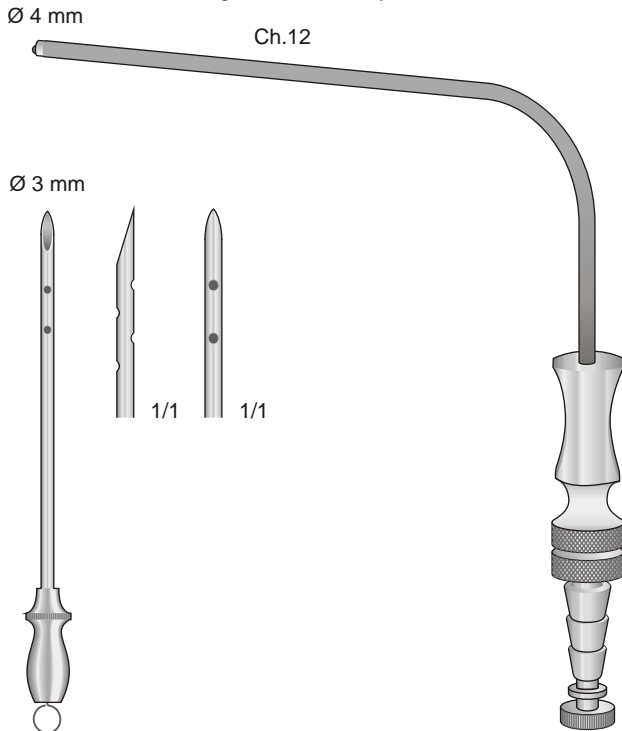

GILMET
18-3640-08
85 mm

FERGUSSON
18-3650-15
150 mm

Silber



SEIFFERT
18-3660-18
180 mm

Kanüle mit Trokardon
Trokar with mandrin
Cannula completa di mandrino
Canula con sonda de guida

Ø 4 mm



Ø Est. 5 mm
Ø Int. 4 mm

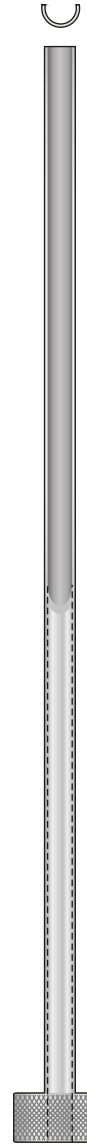

18-3670-20
200 mm

- Ø 1,5 mm
- Ø 1,7 mm
- Ø 2,0 mm

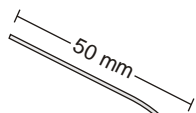

- 18-3680-01 Ø 1,5 mm
- 18-3680-02 Ø 1,7 mm
- 18-3680-03 Ø 2,0 mm

BARNES
18-3680
100 mm

- Ø 1,0 mm
- Ø 1,5 mm

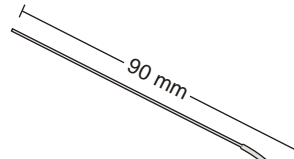

- 18-3690-01 Ø 1,0 mm
- 18-3690-02 Ø 1,5 mm

BARNES
18-3690
125 mm

- Ø 2,0 mm

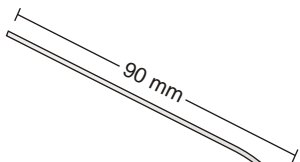

- 18-3700-01 Ø 2,0 mm

BARNES
18-3700
125 mm

- Ø 3,0 mm
- Ø 4,0 mm
- Ø 5,0 mm

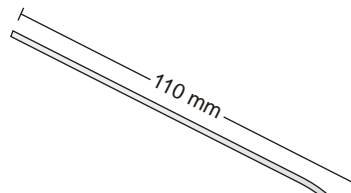

- 18-3710-01 Ø 3,0 mm
- 18-3710-02 Ø 4,0 mm
- 18-3710-03 Ø 5,0 mm

BARNES
18-3710
150 mm

Ø 3.5 mm

Ø 2.0 mm

- 18-3720-01 Ø 2.0 mm / 3.5 mm
350 mm
- 18-3720-02 Ø 2.0 mm / 3.5 mm
500 mm

Olive
Ø 9 mm
18-3720



- 18-3730-01 Ø 2.0 mm
- 18-3730-02 Ø 2.5 mm
- 18-3730-03 Ø 3.0 mm

Olive
Ø 6-9 mm

18-3730
250 mm

Lunghezza Cannula	No.1 0,6 x 0,4	No.2 0,8 x 0,6	No.3 1,0 x 0,8	No.4 1,2 x 1,0	No.5 1,5 x 1,2	No.6 2,0 x 1,6	
SS = 80 mm	18-3740-01	18-3740-02	18-3740-03	18-3740-04	18-3740-05	18-3740-06	For Bypass
S = 100 mm	18-3740-07	18-3740-08	18-3740-09	18-3740-10	18-3740-11	18-3740-12	
M = 120 mm	18-3740-13	18-3740-14	18-3740-15	18-3740-16	18-3740-17	18-3740-18	
L = 145 mm	18-3740-19	18-3740-20	18-3740-21	18-3740-22	18-3740-23	18-3740-24	
LL = 160 mm	18-3740-25	18-3740-26	18-3740-27	18-3740-28	18-3740-29	18-3740-30	For Trans-sphenoidal
LLL = 175 mm	18-3740-31	18-3740-32	18-3740-33	18-3740-34	18-3740-35	18-3740-36	For Trans-sphenoidal

Char. 1	= 0,3 mm
Char. 2	= 0,6 mm
Char. 3	= 1,0 mm
Char. 4	= 1,3 mm
Char. 5	= 1,6 mm
Char. 6	= 2,0 mm
Char. 7	= 2,3 mm
Char. 8	= 2,6 mm
Char. 9	= 3,0 mm
Char. 10	= 3,3 mm

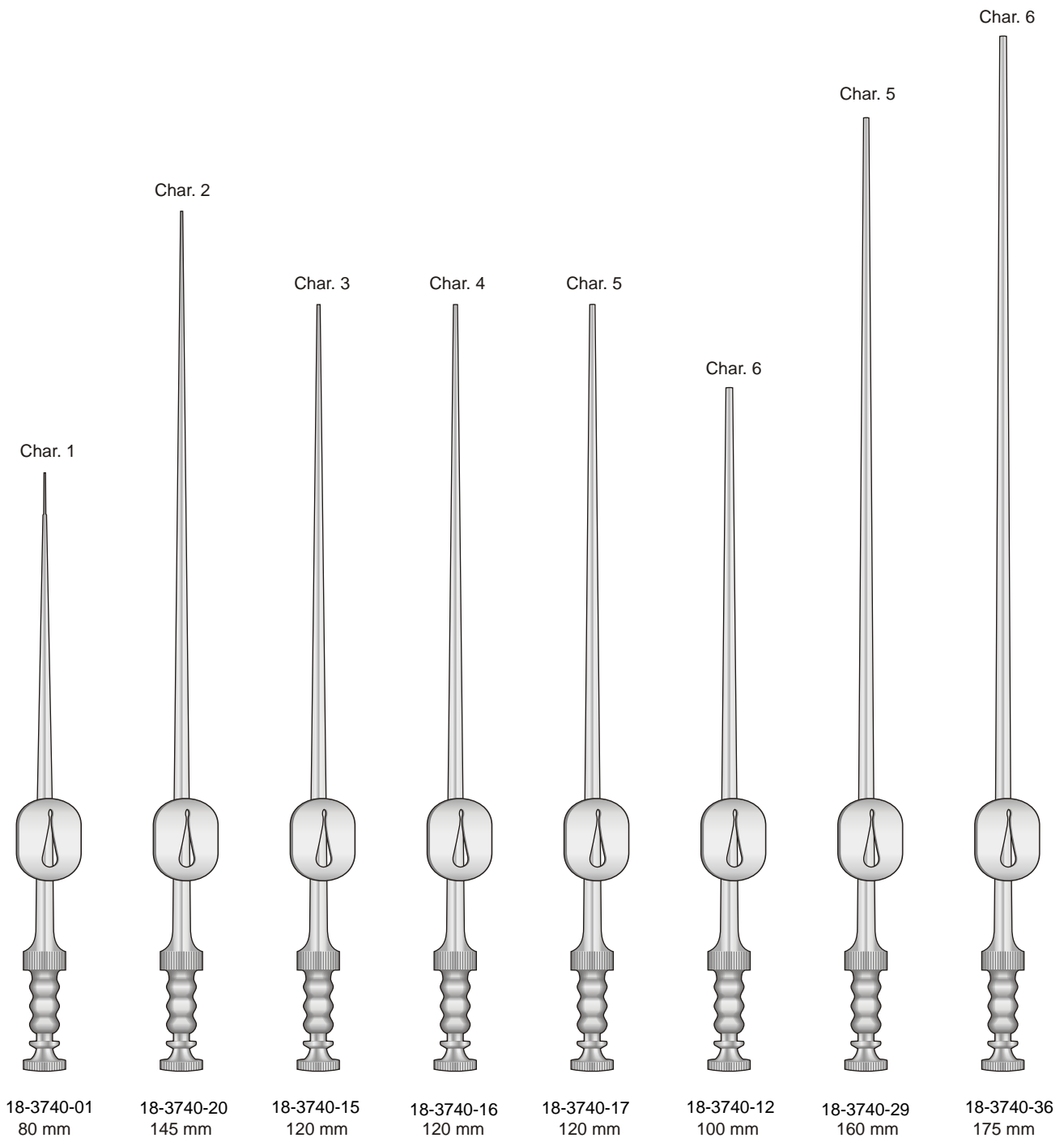

Lunghezza Cannula	No.7 2,5 x 1,9	No.8 3,0 x 2,2	No.9 3,5 x 2,5	No.10 4,0 x 3,0
M = 120 mm	18-3740-37	18-3740-38	18-3740-39	18-3740-40
L = 145 mm	18-3740-41	18-3740-42	18-3740-43	18-3740-44
LL = 160 mm	18-3740-45	18-3740-46	18-3740-47	18-3740-48 For Trans-sphenoidal
LLL = 175 mm	18-3740-49	18-3740-50	18-3740-51	18-3740-52 For Trans-sphenoidal

Char. 1	= 0,3 mm
Char. 2	= 0,6 mm
Char. 3	= 1,0 mm
Char. 4	= 1,3 mm
Char. 5	= 1,6 mm
Char. 6	= 2,0 mm
Char. 7	= 2,3 mm
Char. 8	= 2,6 mm
Char. 9	= 3,0 mm
Char. 10	= 3,3 mm

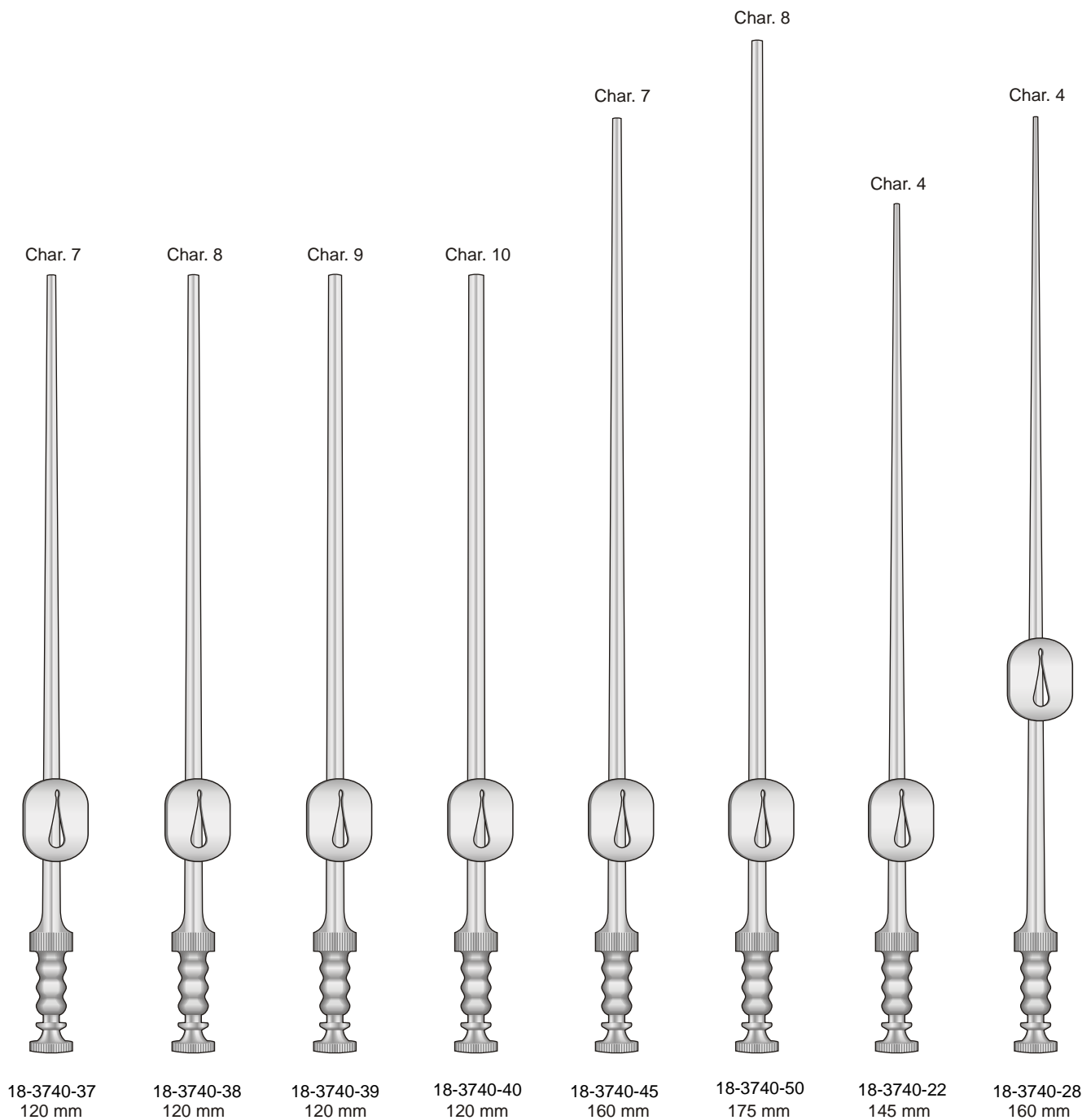

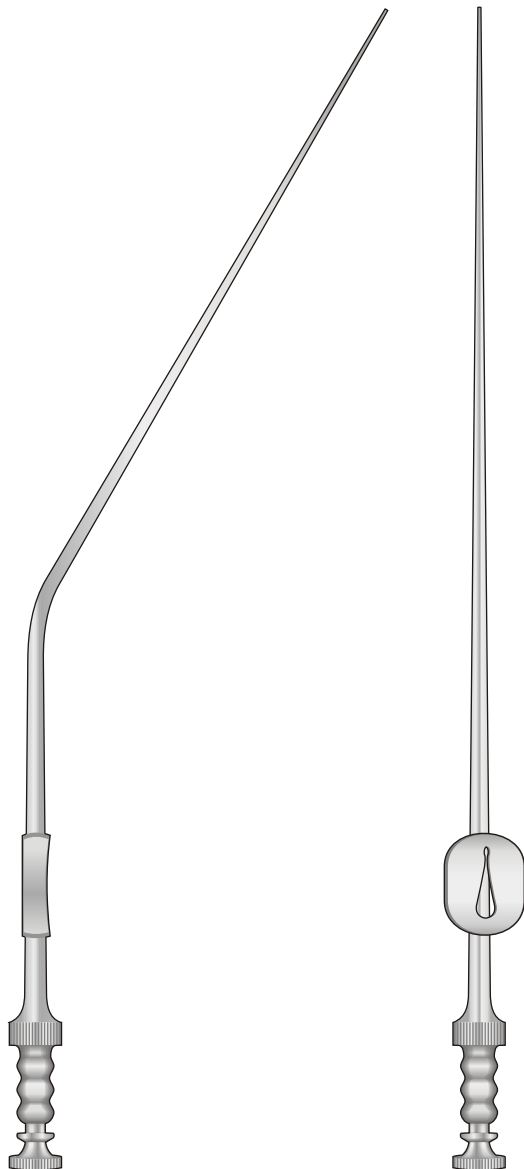

Char. 3	= 1,0 mm
Char. 4	= 1,3 mm
Char. 5	= 1,6 mm
Char. 6	= 2,0 mm
Char. 7	= 2,3 mm
Char. 8	= 2,6 mm
Char. 9	= 3,0 mm
Char. 10	= 3,3 mm
Char. 11	= 3,6 mm
Char. 12	= 4,0 mm

	Lunghezza 160 mm	Lunghezza 180 mm	Lunghezza 205 mm
Char. 3	18-3740-53	18-3740-63	18-3740-73
Char. 4	18-3740-54	18-3740-64	18-3740-74
Char. 5	18-3740-55	18-3740-65	18-3740-75
Char. 6	18-3740-56	18-3740-66	18-3740-76
Char. 7	18-3740-57	18-3740-67	18-3740-77
Char. 8	18-3740-58	18-3740-68	18-3740-78
Char. 9	18-3740-59	18-3740-69	18-3740-79
Char. 10	18-3740-60	18-3740-70	18-3740-80
Char. 11	18-3740-61	18-3740-71	18-3740-81
Char. 12	18-3740-62	18-3740-72	18-3740-82

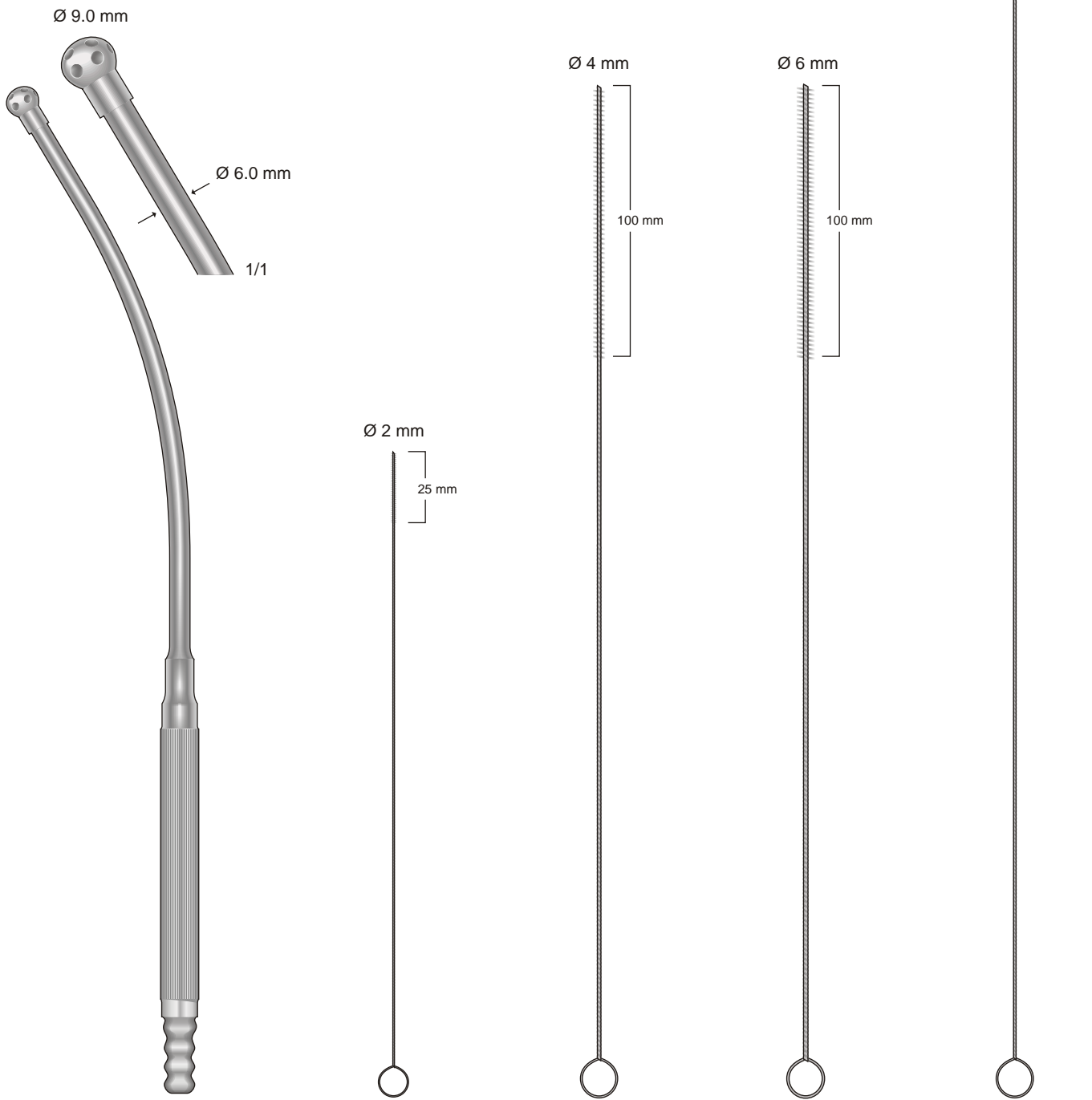

COOLEY
18-3750-30
300 mm

18-3760-01
215 mm

18-3760-02
300 mm

18-3760-03
300 mm

18-3760-04
500 mm

mm: Schnittlänge
Lenght of blades
Lunghezza della lama
Largo de hojas
Longueur de la lame

Metallheft
Metal handle
Manico in metallo
Mango metálico
Manche métal

Holzheft
Wooden handle
Manico in legno
Mango de madera
Manche bois

Metallheft
Metal handle
Manico in metallo
Mango metálico
Manche métal

Metallheft
Metal handle
Manico in metallo
Mango metálico
Manche métal

Resektionsmesser
Resection knives
Coltello per resezione
Cuchillos para resección
Couteaux à résection

Organmesser
Post mortem knives
Coltello per autopsia
Cuchillos para órganos
Couteaux à autopsie

Organmesser
Post mortem knives
Coltello per autopsia
Cuchillos para órganos
Couteaux à autopsie

Hirnmesser
Brain knives
Coltello per cervello
Cuchillos para cerebro
Couteaux à cerveau

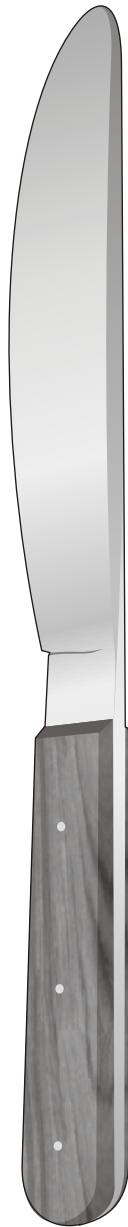
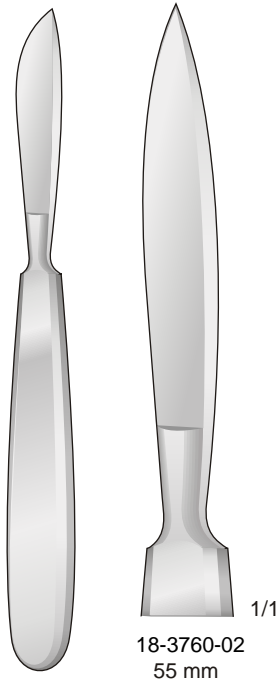
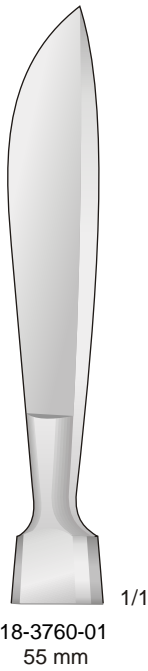

LANGENBECK
18-3760
55 mm

18-3770-01
110 mm

18-3770-02
170 mm

18-3770-03
195 mm

VIRCHOW
18-3780-01
160 mm

VIRCHOW
18-3780-02
200 mm

VIRCHOW
18-3780-03
240 mm

Dermatome komplett mit 1 auswechselbarer Klinge und 2 Spannplatten
 Dermatome complete with 1 interchangeable blade and 2 skin plates
 Dermatomo a mano, con una lama intercambiabile, completo di 2 placche per stendere la pelle
 Dermatomo completo, con 1 hoja intercambiabile y 2 placas para extender la piel
 Dermatome avec 1 lame interchangeable et 2 plaques pour tendre la peau

Einstellbar von 0,1 bis 3,0 mm
 Adjustable from 0,1 to 3,0 mm
 Regolazione da 0,1 a 3,0 mm
 Regulable de 0,1 hasta 3,0 mm
 Réglable en épaisseur de 0,1 à 3,0 mm

Einstellbar von 0,1 bis 4,0 mm
 Adjustable from 0,1 to 4,0 mm
 Regolazione da 0,1 a 4,0 mm
 Regulable de 0,1 hasta 4,0 mm
 Réglable en épaisseur de 0,1 à 4,0 mm

Für handelsübliche Rasierklingen
 For usual razor blades
 Per lamette standard
 Para hojas de afeitar usuales
 Pour lames de rasoir modèle standard

Spanplatte
 Skin Fixing Plate
 Placca per stendere la pelle
 Placa para extender la piel
 Plaque pour tendre la peau



SCHINK
18-3790

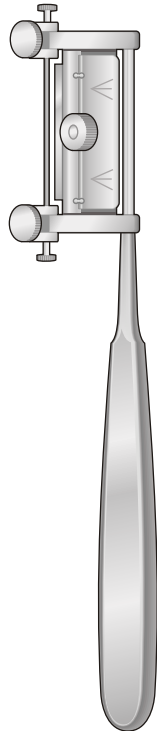

SILVER
18-3800-01
190 mm

Ersatzklinge, allein
 Spare Blade only
 Lama di ricambio sola
 Hoja de repuesto
 Lame de rechange, seule

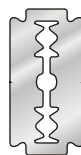

SILVER
18-3800-02
43 mm

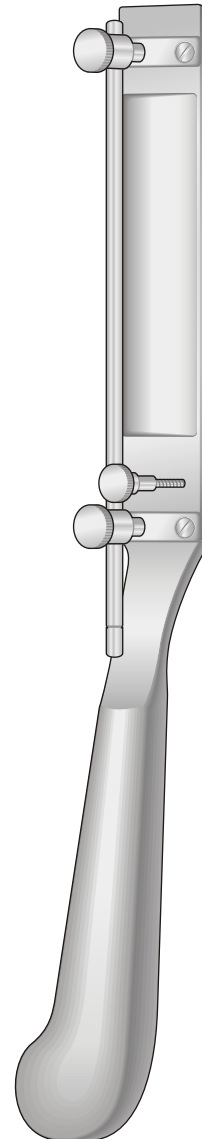

SCHINK
18-3810-01
300 mm

Ersatzklinge, allein
 Spare Blade only
 Lama di ricambio sola
 Hoja de repuesto
 Lame de rechange, seule



SCHINK
18-3810-02
102 mm

Dermatome komplett mit 1 auswechselbarer Klinge und 2 Spannplatten

Dermatome complete with 1 interchangeable blade and 2 skin plates

Dermatomo a mano, con una lama intercambiabile, completo di 2 placche per stendere la pelle

Dermatomo completo, con 1 hoja intercambiabile y 2 placas para extender la piel

Dermatome avec 1 lame interchangeable et 2 plaques pour tendre la peau

Einstellbar von 0,1 bis 1,5 mm

Adjustable from 0,1 to 1,5 mm

Regolazione da 0,1 a 1,5 mm

Regulable de 0,1 hasta 1,5 mm

Réglable en épaisseur de 0,1 à 1,5 mm

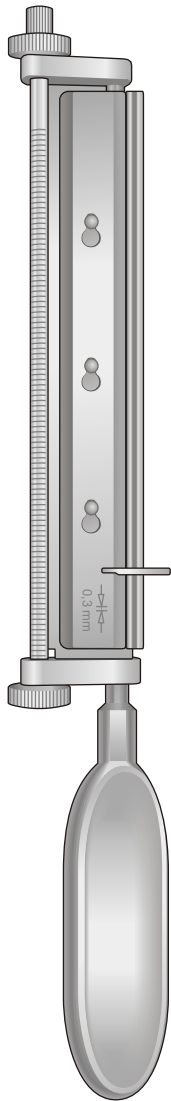

WATSON
18-3820-01
300 mm

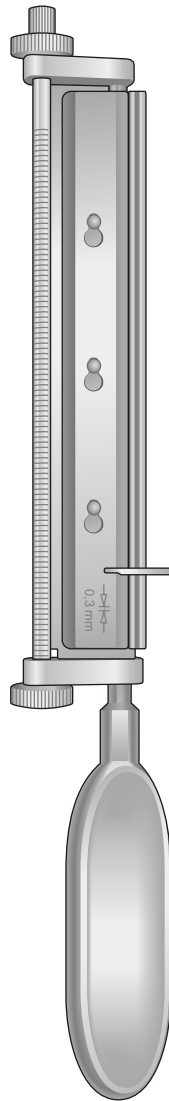

COBBETT
18-3820-02
300 mm

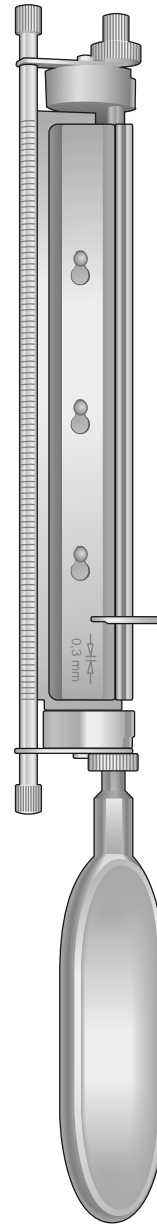

HUMBY
18-3820-03
320 mm

Ersatzklinge, allein
Spare Blade only
Lama di ricambio sola
Hoja de repuesto
Lame de rechange, seule



HUMBY
18-3820-04
157 mm

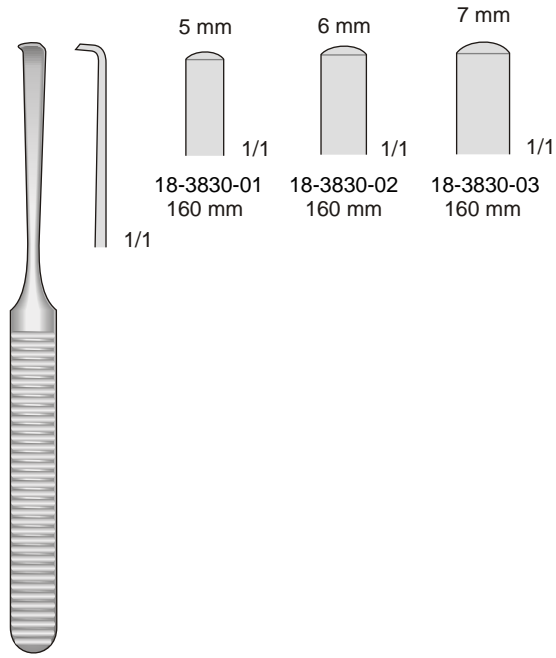

18-3830
160 mm

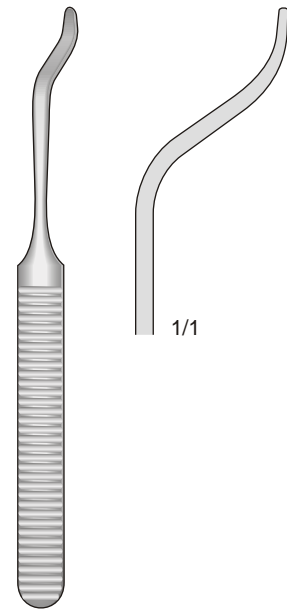

18-3840-16
160 mm

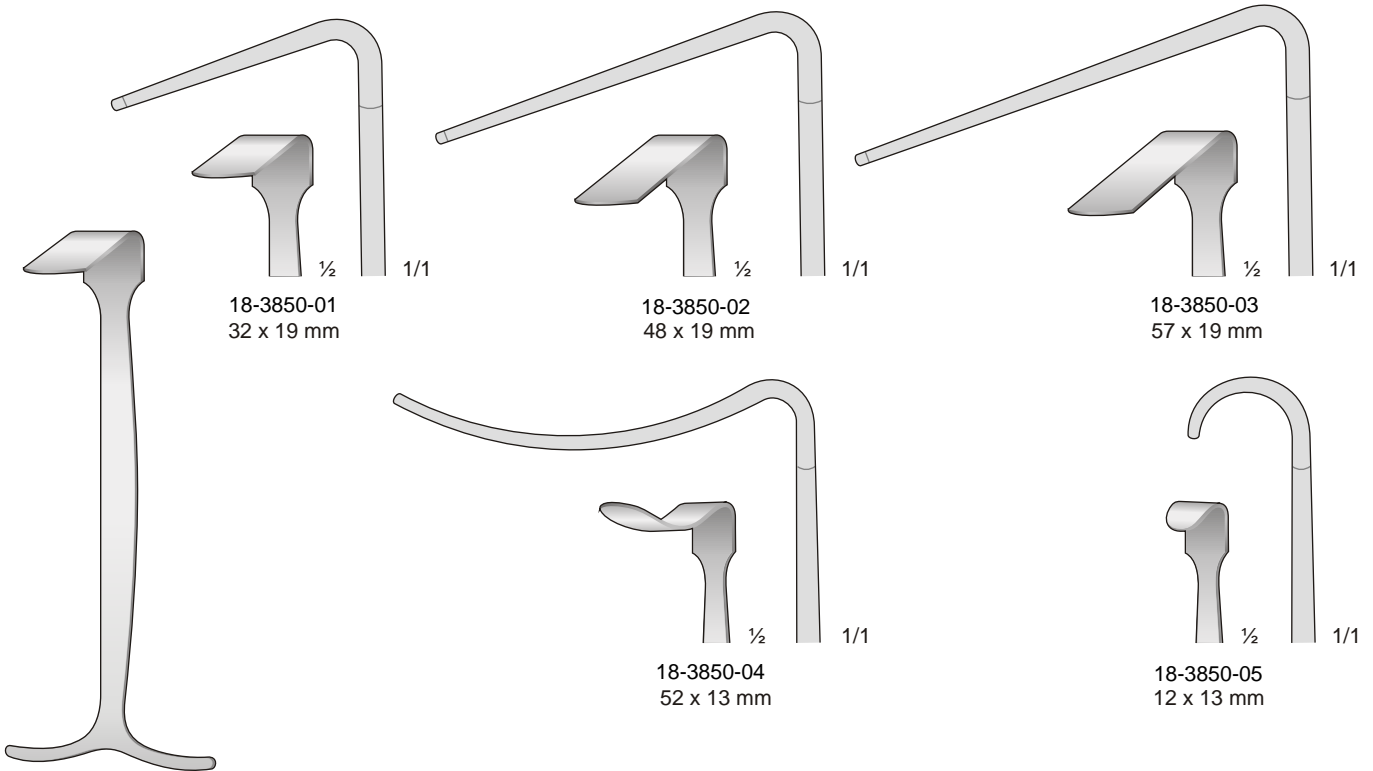

SMILLIE
18-3850
140 mm

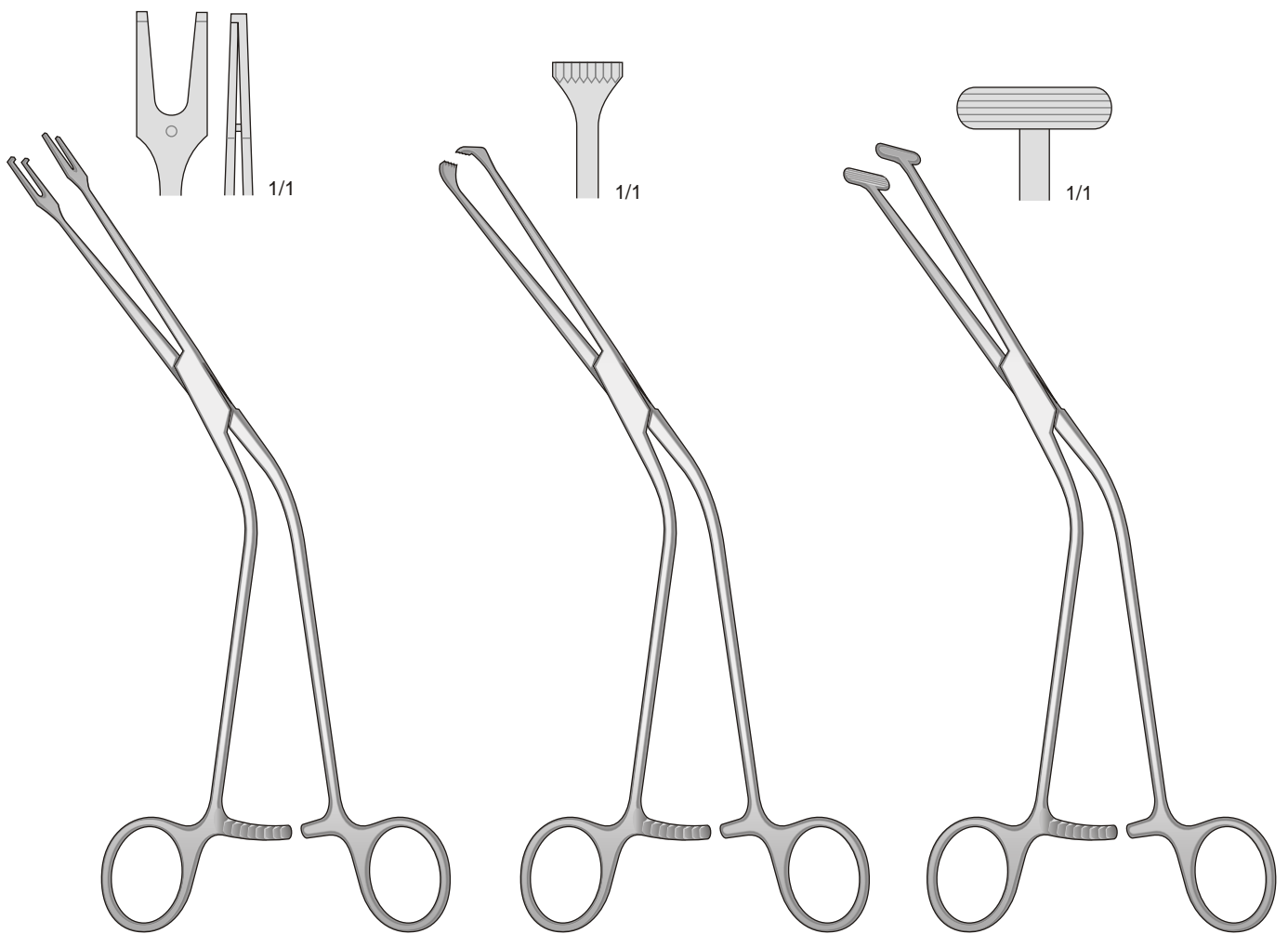

MILLIN
18-3860-01
245 mm

MILLIN
18-3860-02
220 mm

MILLIN
18-3860-03
245 mm

Atraumatische - Atraumatic
Atraumatiche - Atraumáticas
Atraumatiques

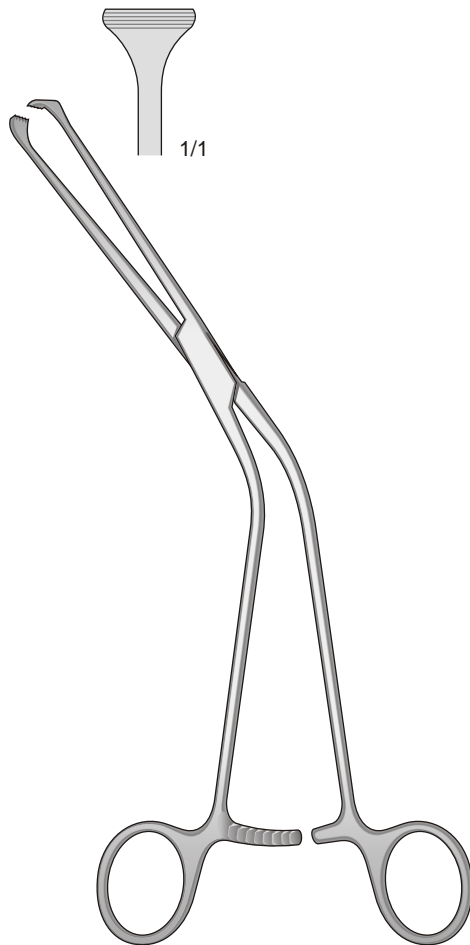

MILLIN
18-3860-04
220 mm

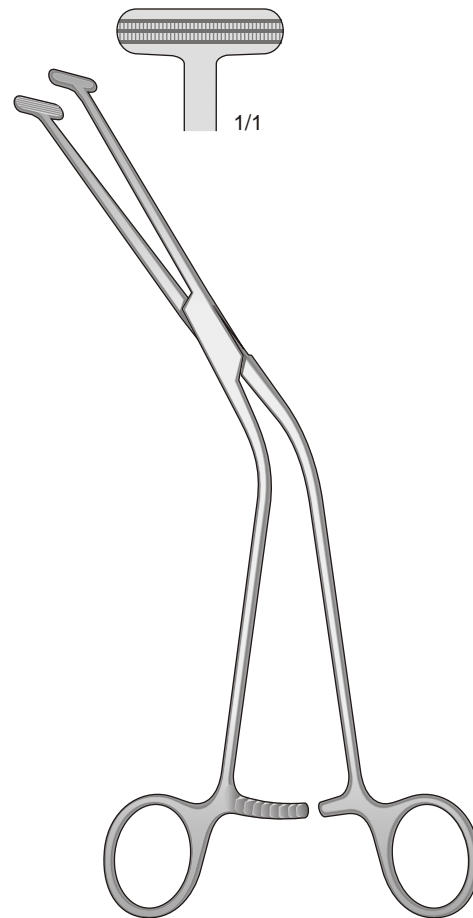

MILLIN
18-3860-05
245 mm

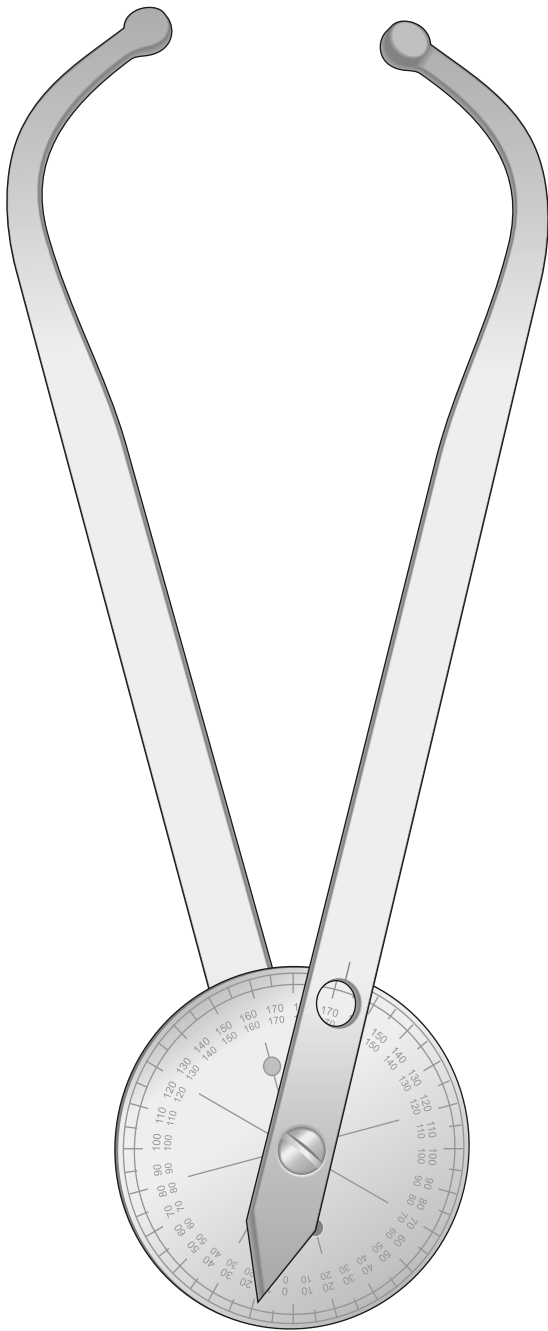

18-3870-24
240 mm

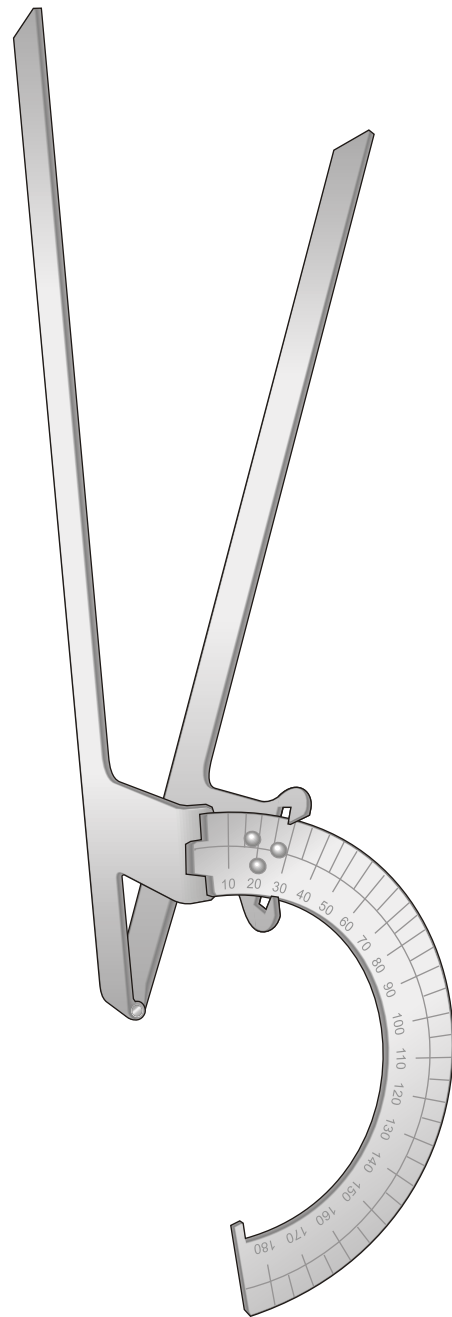

18-3870-23
235 mm

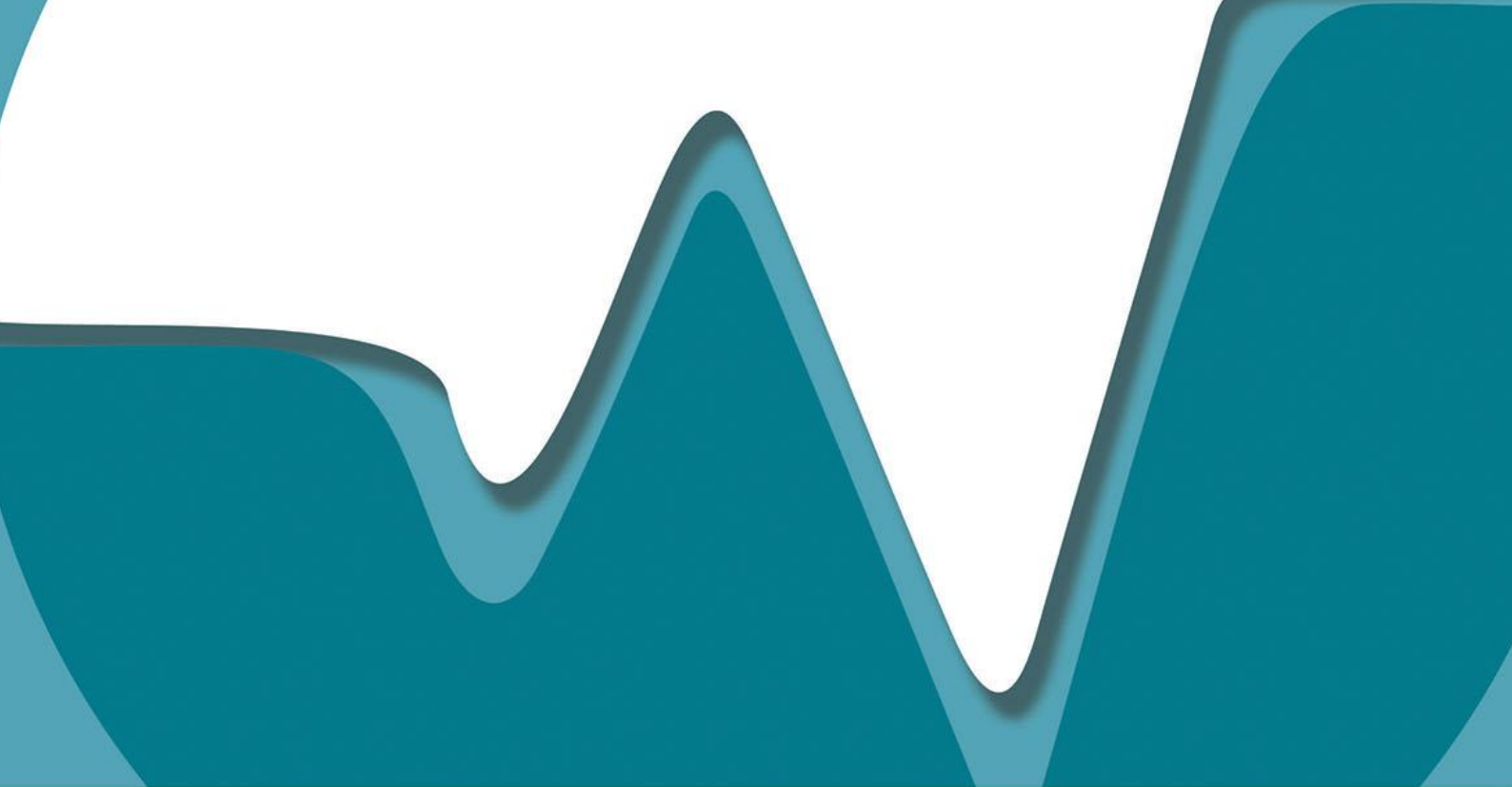

Factory Location:

4 -KM Daska Road Sialkot 51310 Pakistan

Tel: +92 52 352 52 78

Fax: +92 52 352 52 77

E-mail: info@wrangler.pk

Web: www.wrangler.pk

